

# ***ATRA WEBINAR***

## **An Introduction to the 68RFE**

**Sponsored By:**



**SEAL AFTERMARKET  
PRODUCTS™**

*YOUR SOURCE FOR ENGINEered solutions*



**Presented by:  
Steve Garrett  
ATRA**



# Today's Presentation Sponsored By:

---



# Lwiggins@ATRA.com

---

- ✿ **Connections**
- ✿ **Handout**
- ✿ **Questions**
- ✿ **Survey**



**SEAL AFTERMARKET  
PRODUCTS**  
*your source for engineered solutions*

# Chrysler - 68RFE

## An Introduction to the 68RFE



# Operation of the 68RFE

## What makes up the 68RFE?

The 68RFE offers full electronic control of all automatic up and downshifts. Features include:

- Real Time adaptive closed-loop shift and pressure control
- Electronic shift and torque converter clutch controls (By altering the shift schedule, line pressure, and converter clutch control, this helps to reduce heat generation and increase transmission cooling).
- Dual-Stage transmission fluid pump with electronic pressure control (reducing pressure solenoid). The primary side of the pump works continuously; the secondary stage is bypassed when demand is low.
- A High-Travel torque converter damper assembly (allows an earlier torque converter clutch engagement to reduce slippage).
- One piece case with high lateral, vertical and torsional stiffness to reduce NVH
- Dual Filters protect the pump and other components.
- Independent lubrication and cooler circuits assure ample pressure for normal transmission operation (even if the cooler is restricted due to extreme COLD temperatures).



# Clutch Operation

## 45/545RFE vs. 68RFE

Shift Lever	Gear			Applied Input Clutch	Applied Holding Clutch	Gear Ratios		
	45RFE	545RFE	68RFE			45RFE	545RFE	68RFE
<b>P</b>	Park	Park	Park		L/R			
<b>R</b>	Reverse	Reverse	Reverse	Reverse	L/R	3.000	3.000	4.444
<b>N</b>	Neutral	Neutral	Neutral		L/R			
<b>D</b>	1	1	1	UD	L/R & ORC	3.000	3.000	3.231
	2	2	2	UD	2C	1.667	1.667	1.837
	2 <sup>nd</sup> Prime	2 <sup>nd</sup> Prime	3	UD	4C	1.500	1.500	1.410
	3	3	4	UD/OD		1.000	1.000	1.000
	4	4	5	OD	4C	0.750	0.750	0.816
			5	OD	2C		0.667	0.625

\* - When output speed is greater than 150 rpm the L/R clutch is released and the ORC is the holding element before the 1-2 shift

\*\* - Failsafe is 3<sup>rd</sup> gear on the 45/545RFE and 4<sup>th</sup> gear on the 68RFE (vehicles with ERS will not have a manual low “2<sup>nd</sup>” gear while in failsafe).

\*\*\* - Design changes in the 4C clutch hub have allowed for the full time 6 speed.

# Servicing and Oil Fill

## Fluid level

It is important to note that the proper fluid level is set using a scan tool for temperature readings to achieve the fill level.

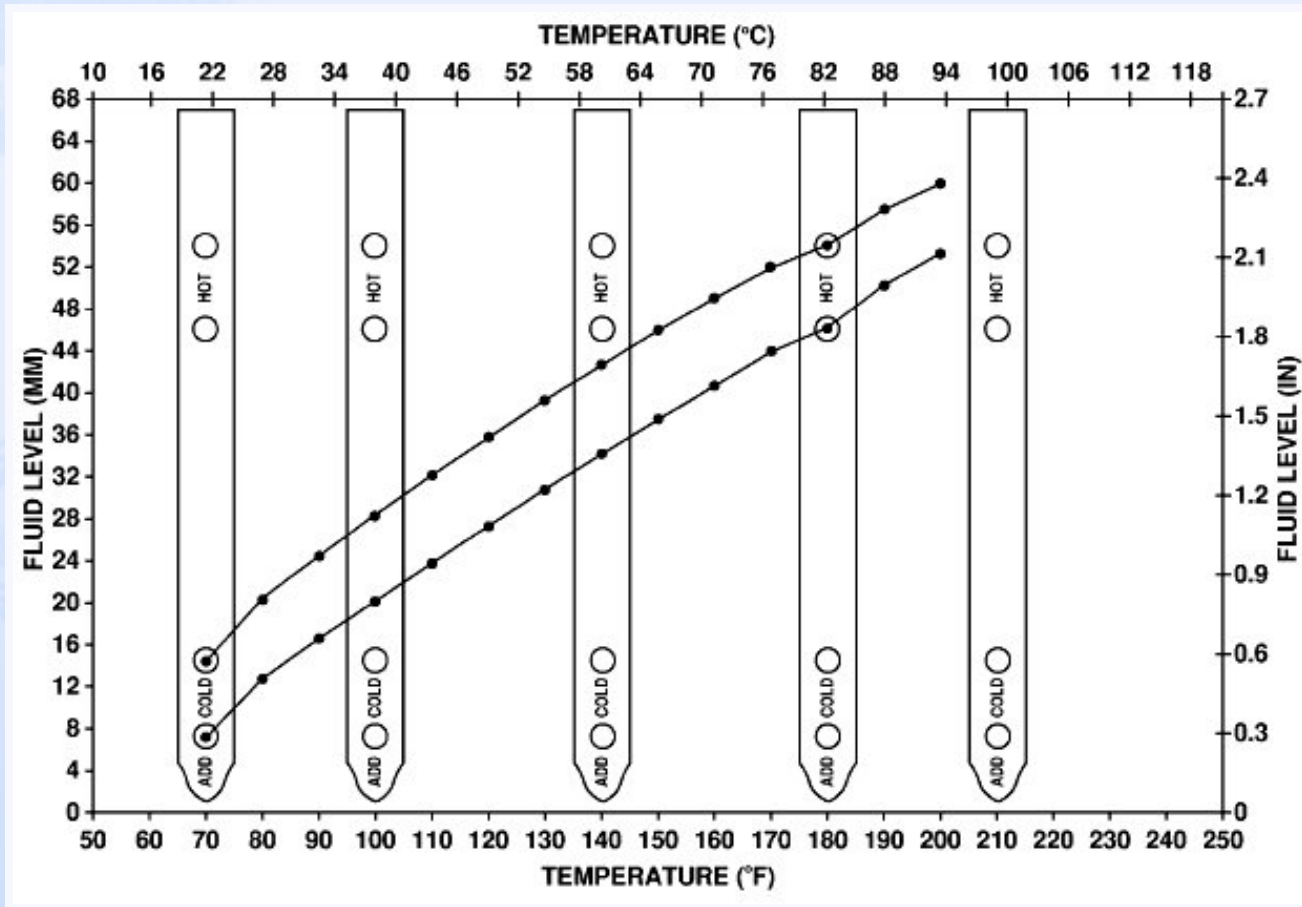

- Service and Filter Change – 10 pints (5 quarts)
- Overhaul with Converter Replacement – 24 pints (12 quarts)

# Recommended Fluid

## Mopar +4 Fluid

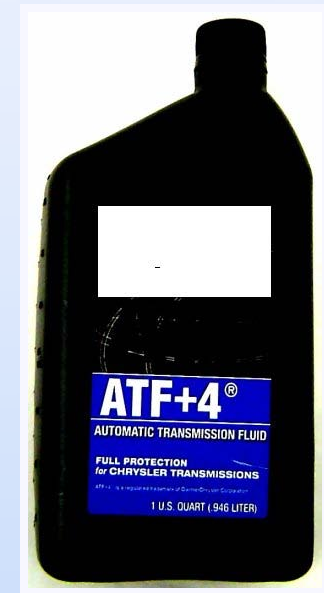
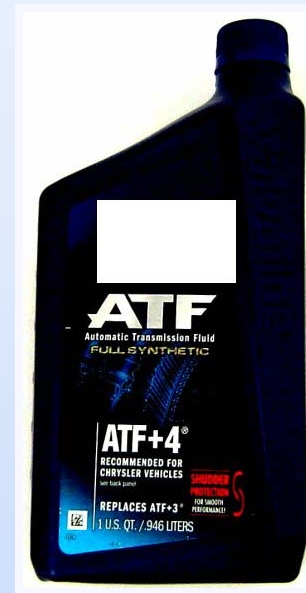



# Pressure Testing

## Pressure Ports and Special Tools

There are a couple different methods to pressure test the 68RFE. External on the case there are two threaded taps that a conventional pressure gauge can hook into (Damper Apply and Damper Release). Because of this, special tools must be used when doing a line pressure test.

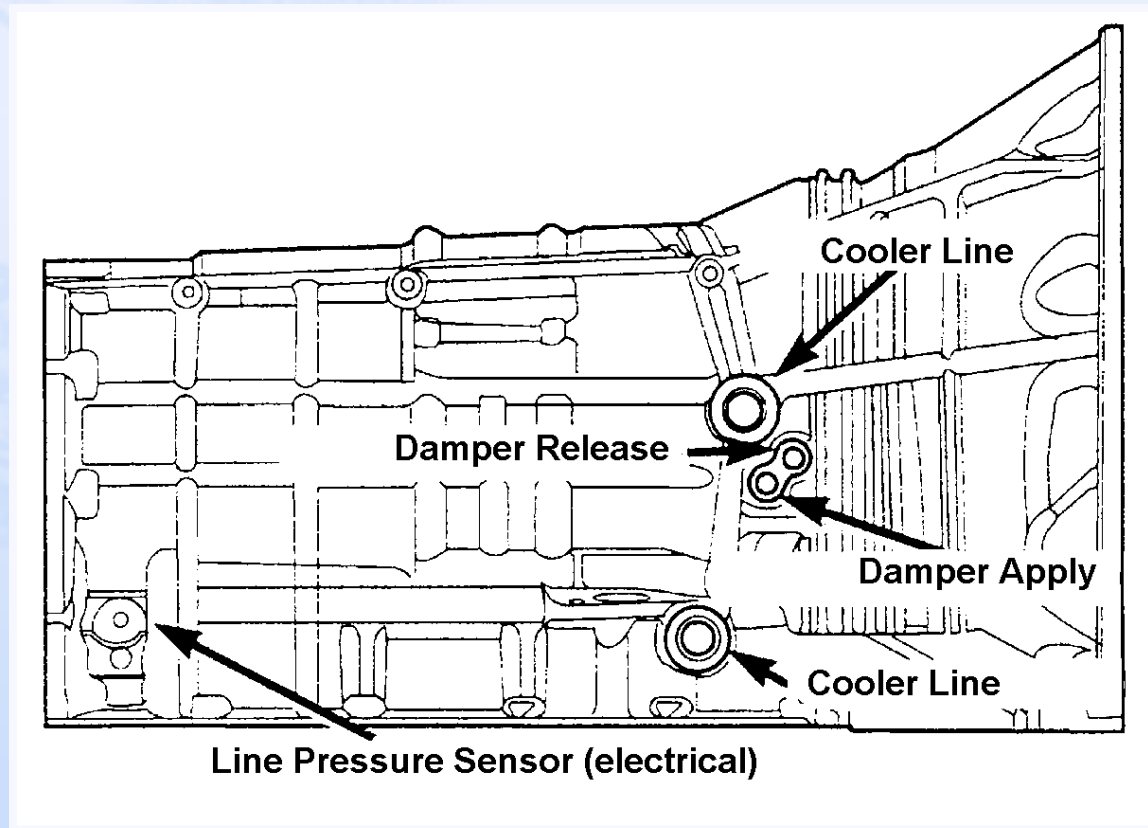

# TCM Quick Learn

## RLE and RFE Transmissions

Quick learn allows the electronic transmission system to recalibrate itself. Quick learn should be performed if any of the following procedures are performed:

- Transmission Assembly Replacement.
- Transmission Control Module Replacement.
- Solenoid Pack Replacement.
- Clutch Plate and/or Seal Replacement.
- Valve Body Replacement or Recondition.

To perform the Quick Learn Procedure, the following conditions must be met:

- No DTCs
- Brakes must be applied.
- Engine speed must be above 500 rpm
- Throttle angle (TPS) must be less than 3 degrees.
- Shift lever position must stay in PARK until prompted to shift to OVERDRIVE.
- Shift lever position must stay in OVERDRIVE after the Shift To Overdrive prompt until the scan tool indicates the procedure is complete.
- Calculated oil temperature must be above 60 and below 200 degrees F.

# Drive Learn - RFE

## Fine Tuning Shift Qualities

The 68RFE as well as the entire RFE line of transmission have the ability to “Fine Tune” individual shifts that may not have been refined with the Quick Learn Process. These include:

- Smooth 1<sup>st</sup> Neutral to Drive Shift
- Smooth Neutral to Drive Garage Shift
- 1<sup>st</sup> 2-3 Shift after a restart or Shift to Reverse
- Smooth 2-3 and 3-4 Upshift
- Smooth 4-3 Coastdown and Part Throttle 4-3 Kickdown
- Smooth 1-2 Upshift and 3-2 Kickdown
- Smooth Manual 2-1 Pulldown Shift as well as a Neutral to Reverse Shift
- Smooth Neutral to Reverse Shift
- Smooth 4-5 Upshift
- Smooth 5-6 Upshift

***When to Perform Drive Learn Shifting and what to expect as the outcome of Drive Learn.***

When a transmission is repaired and a Quick Learn procedure has been performed on the Transmission Control Module (TCM), the following Drive Learn procedure can be performed to “fine tune any shifts” which are particularly objectionable.

***NOTE: It is not necessary to perform the complete Drive Learn procedure every time the TCM is Quick Learned. Perform only the portions which target the objectionable shifts.***

# Shift Schedules

The TCM has programming that allow it to select a variety of shift schedules. Shift schedule selection is dependent on the following:

- Shift Lever Position
- Throttle Position
- Engine Load
- Fluid Temperature
- Software level

*As Driving Conditions change, the TCM appropriately adjusts the shift schedule.*

Schedule	Condition	Expected Operation
<b>Extreme Cold</b>	Oil temperature below -27° C (-16° F)	<ul style="list-style-type: none"> <li>■ Park, Reverse, Neutral and 1<sup>st</sup> and 3<sup>rd</sup> gear only in D position, 2<sup>nd</sup> gear only in Manual 2 or L</li> <li>• No EMCC</li> </ul>
<b>Super Cold</b>	Oil temperature below -24° C (-12° F) and -12° C (10° F)	<ul style="list-style-type: none"> <li>■ Delayed 2-3 upshift</li> <li>• Delayed 3-4 upshift</li> <li>• Early 4-3 coastdown shift</li> <li>• High speed 4-2, 3-2, 2-1 kickdown shifts are prevented</li> <li>• Shifts at high throttle openings will be early</li> <li>• No EMCC</li> </ul>
<b>Cold</b>	Oil temperature below -12° C (10° F) and 2° C (36° F)	<ul style="list-style-type: none"> <li>■ Shift schedule is the same as Super Cold except that the 2-3 upshifts are not delayed</li> </ul>
<b>Warm</b>	Oil temperature below 4° C (40° F) and 27° C (80° F)	<ul style="list-style-type: none"> <li>■ Normal operation (upshift, kickdowns, and coastdowns)</li> <li>• No EMCC</li> </ul>
<b>Hot</b>	Oil temperature below 27° C (80° F) and 115° C (240° F)	<ul style="list-style-type: none"> <li>■ Normal operation (upshift, kickdowns, and coastdowns)</li> <li>• Normal EMCC operation</li> </ul>
<b>Overheat</b>	Oil temperature below 115° C (240° F) or engine coolant temperature above 118° C (244° F)	<ul style="list-style-type: none"> <li>■ Delayed 2-3 upshift</li> <li>• Delayed 3-4 upshift</li> <li>• 3<sup>rd</sup> gear FEMCC from 30-48 mph</li> <li>• 3<sup>rd</sup> gear PEMCC above 35 mph</li> <li>• Above 25 mph the torque converter will not unlock unless the throttle is closed or if a wide open throttle 2<sup>nd</sup> PEMCC to 1<sup>st</sup> kickdown is made</li> </ul>



# Diagnostic Tools

## Keep Testing Simple



**DRB Handheld**



**Star Tester**



**8888**



**8815**  
**8815-1**



# Rebuild Procedures End Plays

There are two end play settings that need to be set during repairs.

Front End Play is 0.020-0.029"

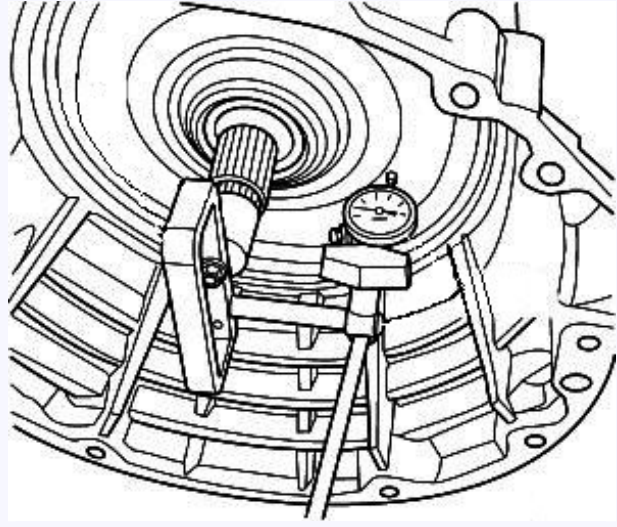

Rear End Play is 0.010-0.020"

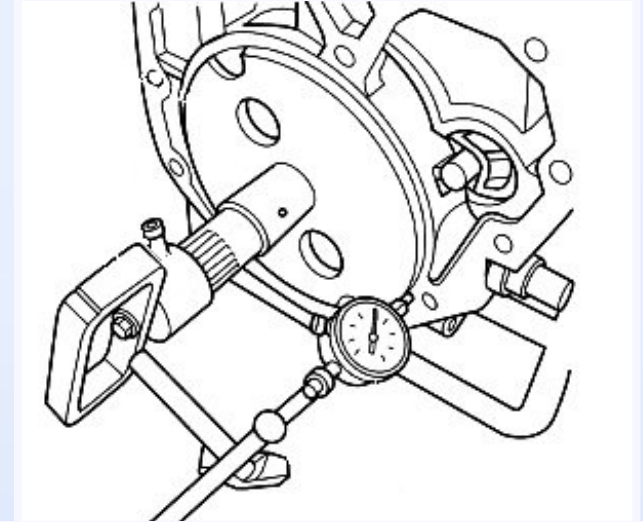

Bearing Spacer

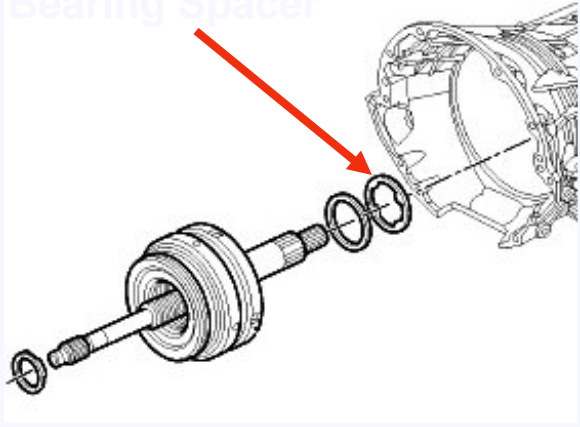

Select Disc

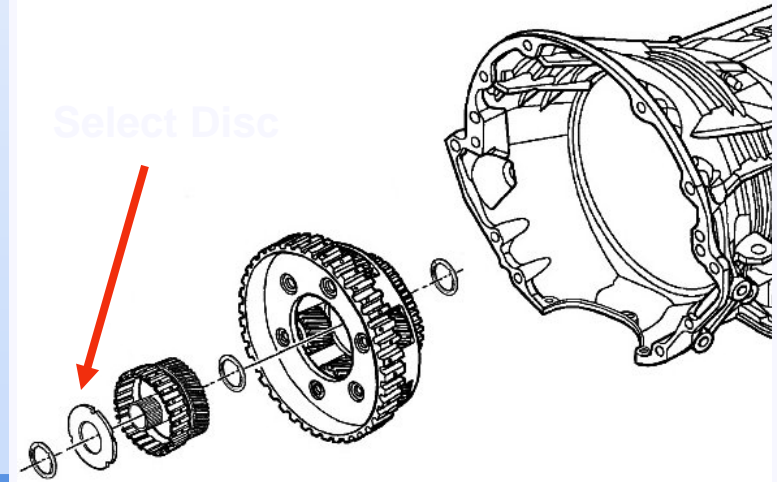

# Hydraulics Oil Pump

The 68RFE and 45RFE pump assembly are hub less and have no torque converter seal.

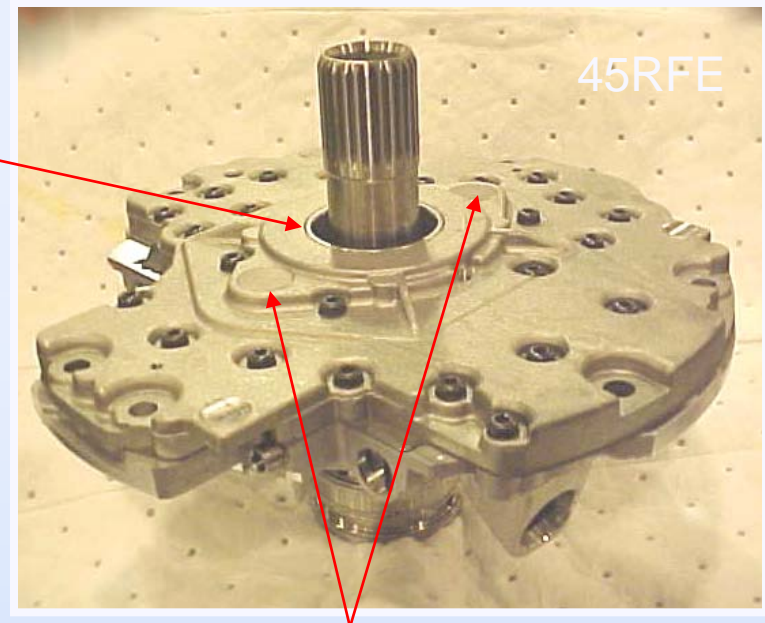
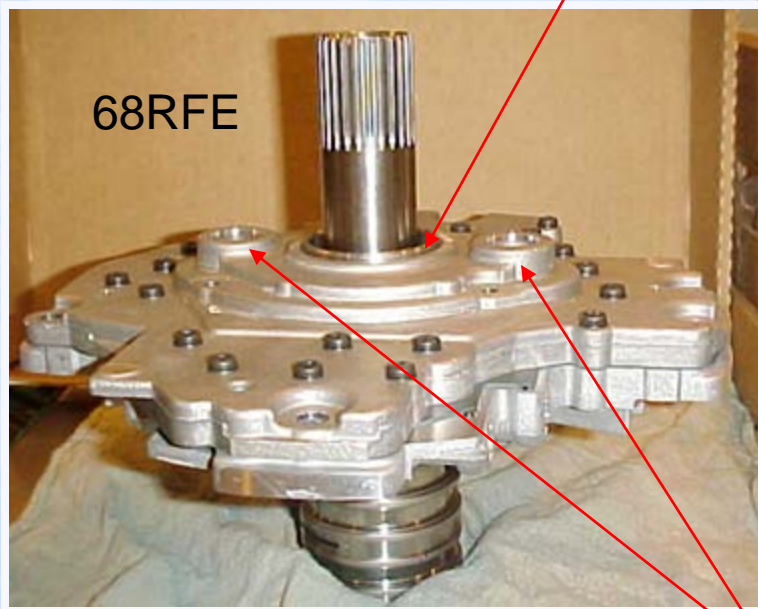

The top of the driven gears are even with the casting surface.

The driven gears on the 68 RFE are below the casting surface. The gears are located on fixed shafts which are pressed into the pump housing.

# Hydraulics Oil Pump

The pump gears are redesigned with the 68RFE and ride on posts instead of being self centered gears. The 68RFE does have a wider gear for greater volume.

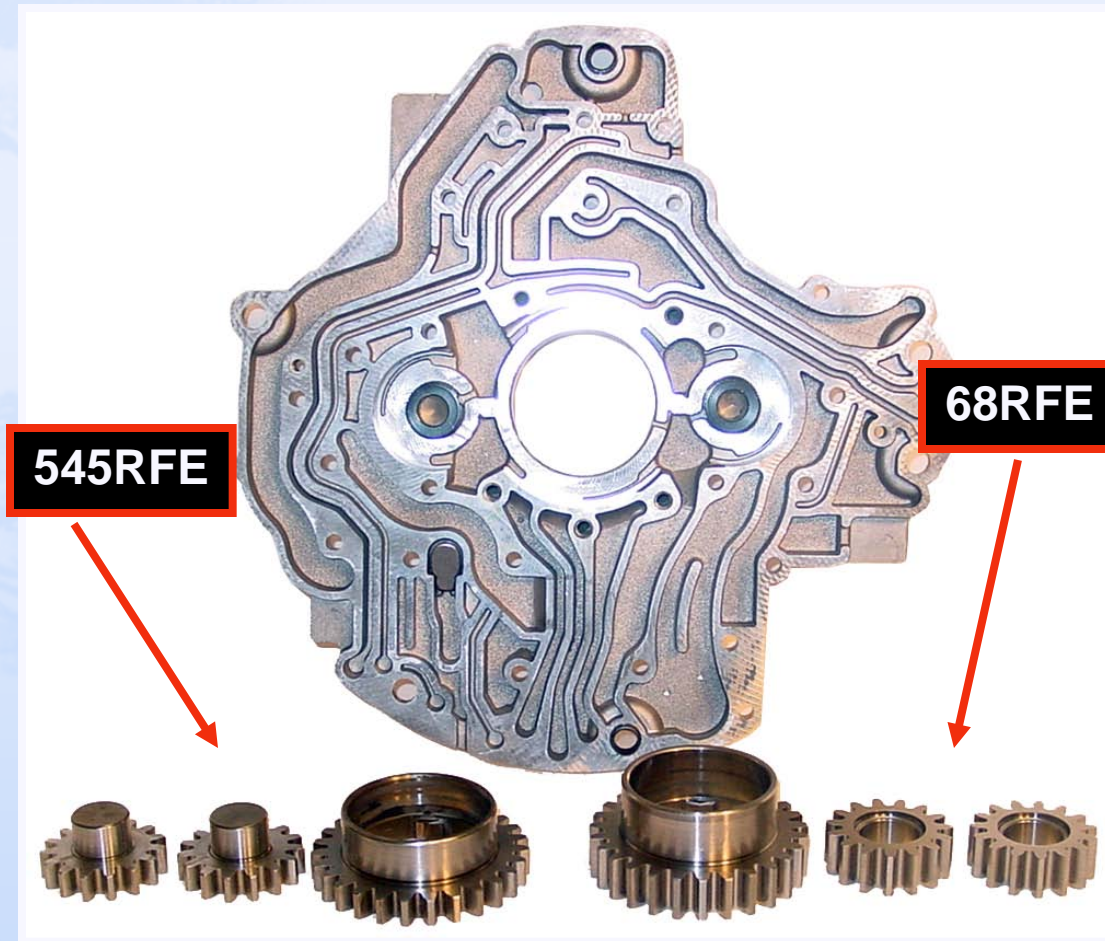



# Hydraulics Oil Pump

The pump drive gear is redesigned with the 68RFE and 4 drive lugs compared to the earlier design with only 2.

545RFE

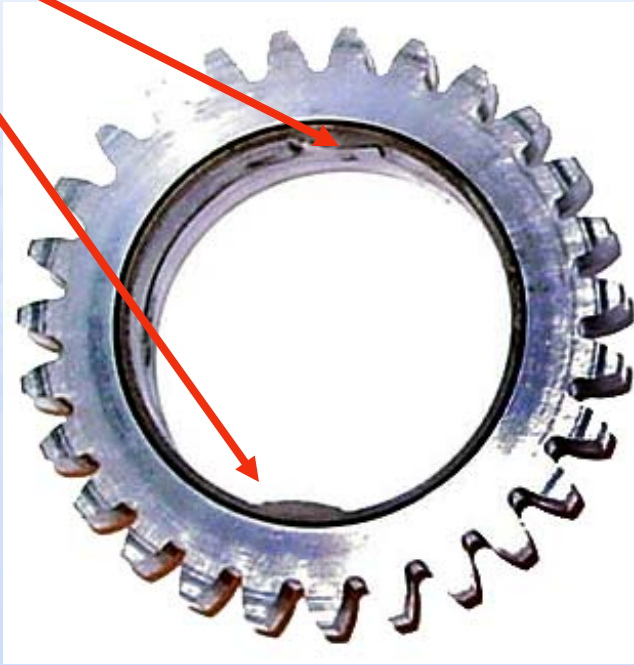

68RFE

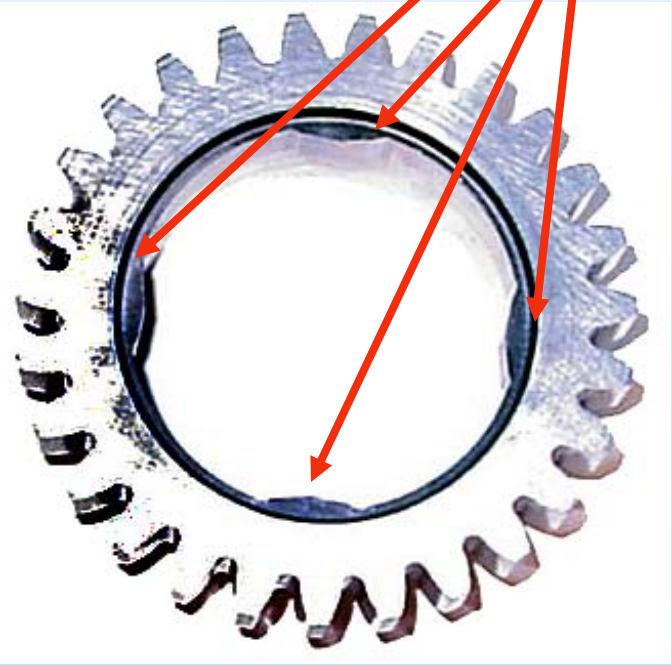

# Hydraulics

## Oil Pump - Valves

Main differences in the 68RFE pumps compared to the 545RFE pump are 2 heavier springs. Pressure Regulator spring and Torque Converter Limit Valve spring have been increased in pressure.

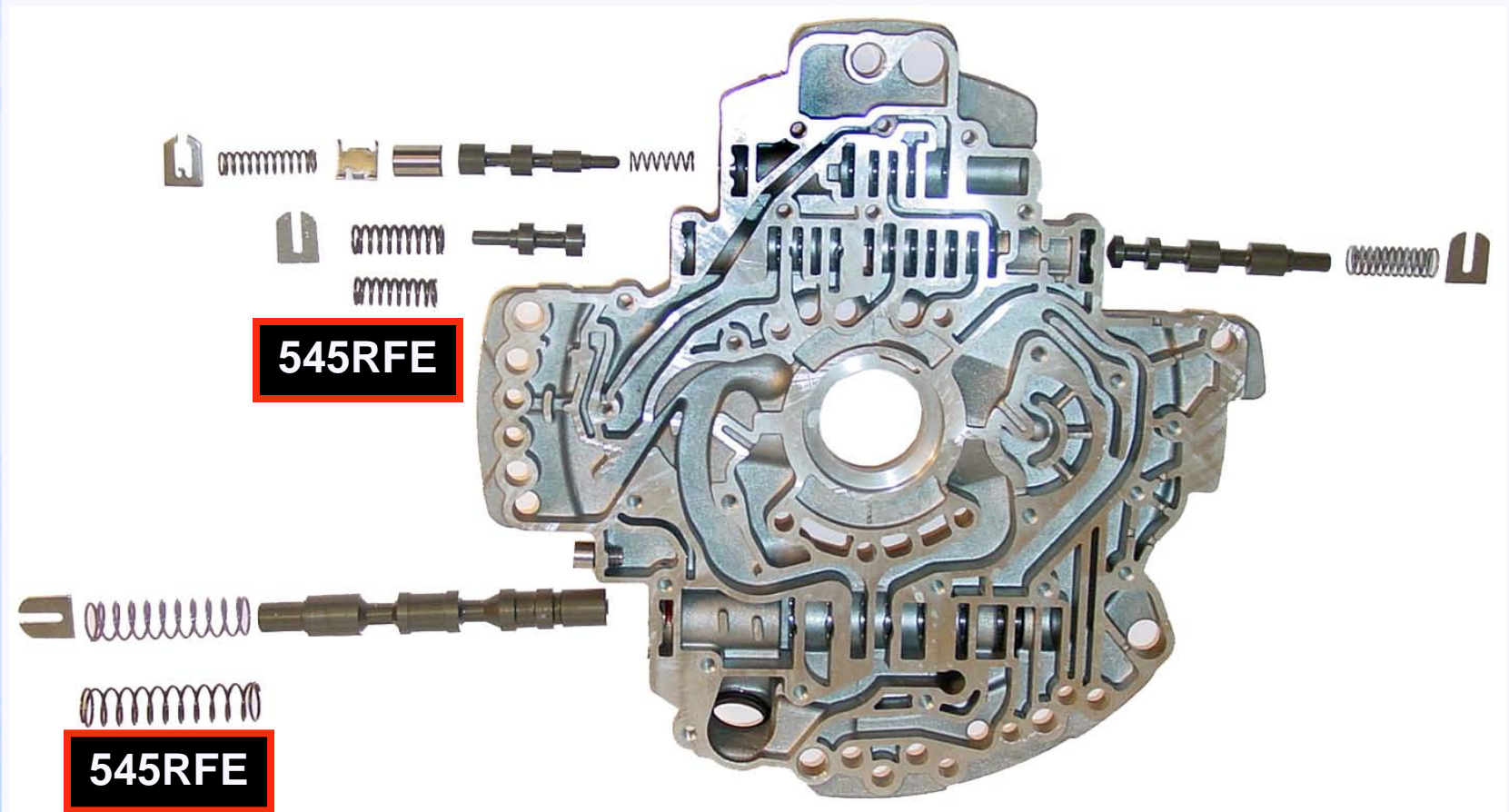



# Hydraulics

## Oil Pump - Valves

**Converter Clutch Switch Valve** – Used to control the direction of oil flow to the torque converter. When the converter clutch is released (CC Switch valve is downshifted). Hydraulic pressure is supplied to the front (OFF) side of the torque converter clutch. When the converter clutch is applied (CC Switch valve upshifted), regulated oil pressure is supplied to the back (ON side of the converter clutch

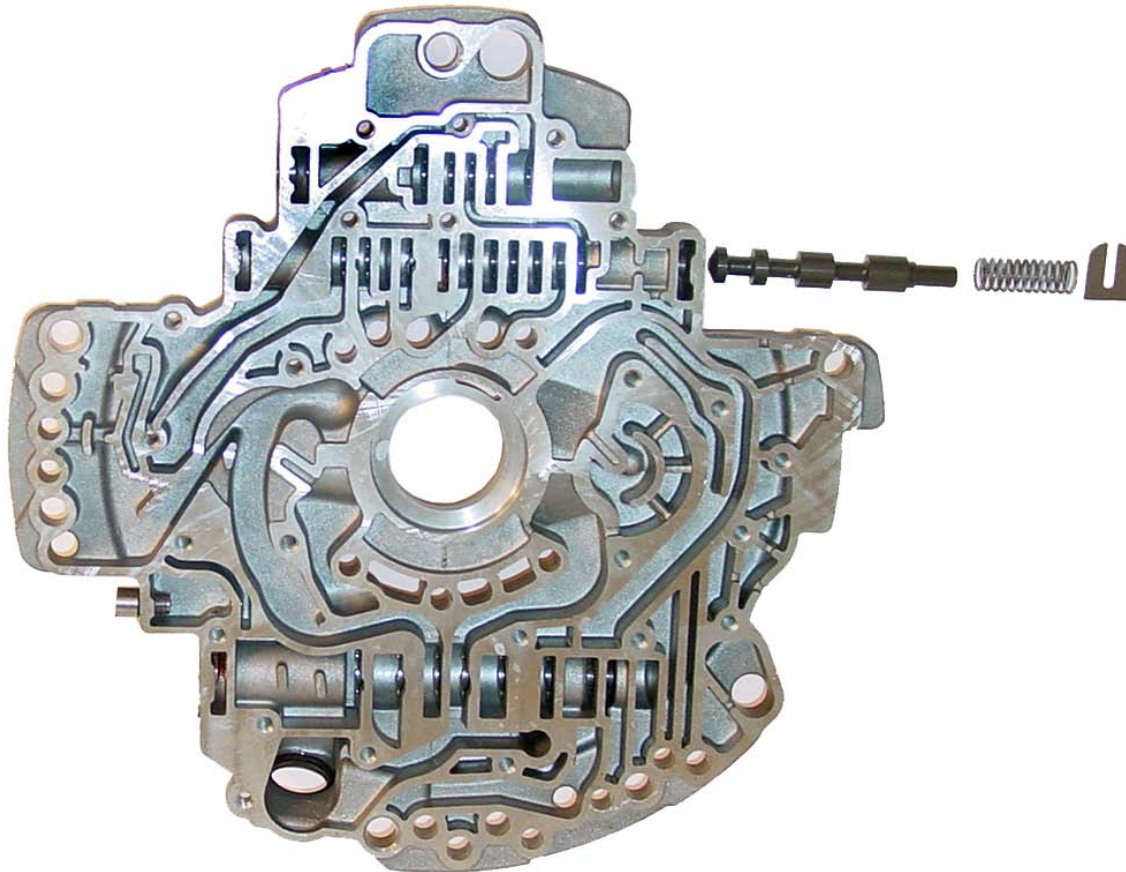

# Hydraulics

## Oil Pump - Valves

**Converter Clutch Regulator (control) Valve and Accumulator** – Used to control the hydraulic pressure supplied to the back (ON) side of the torque converter clutch.

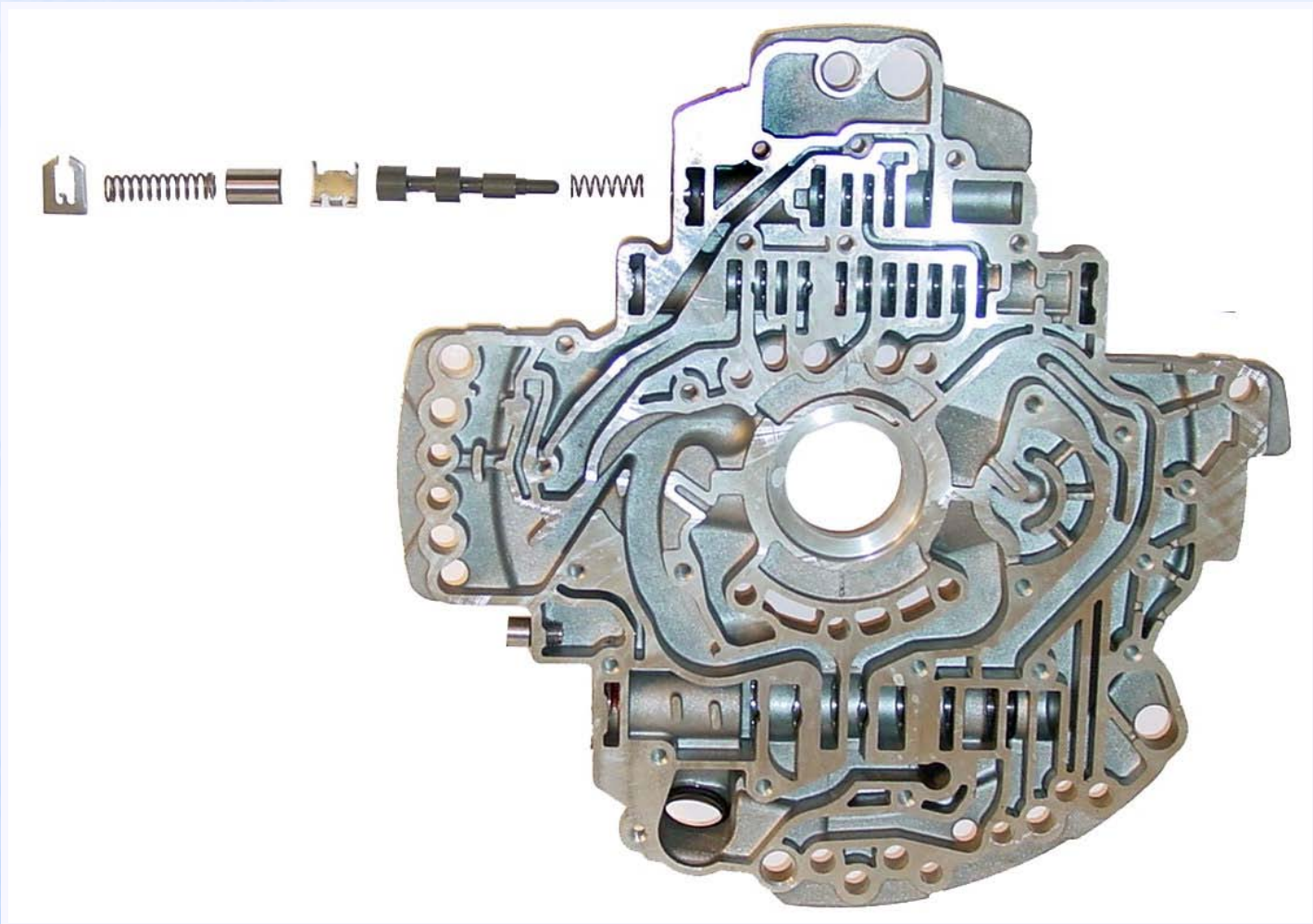



# Hydraulics

## Oil Pump - Valves

**Torque Converter Limit Valve** – Serves to limit the maximum pressure supplied to the front side of the torque converter clutch.

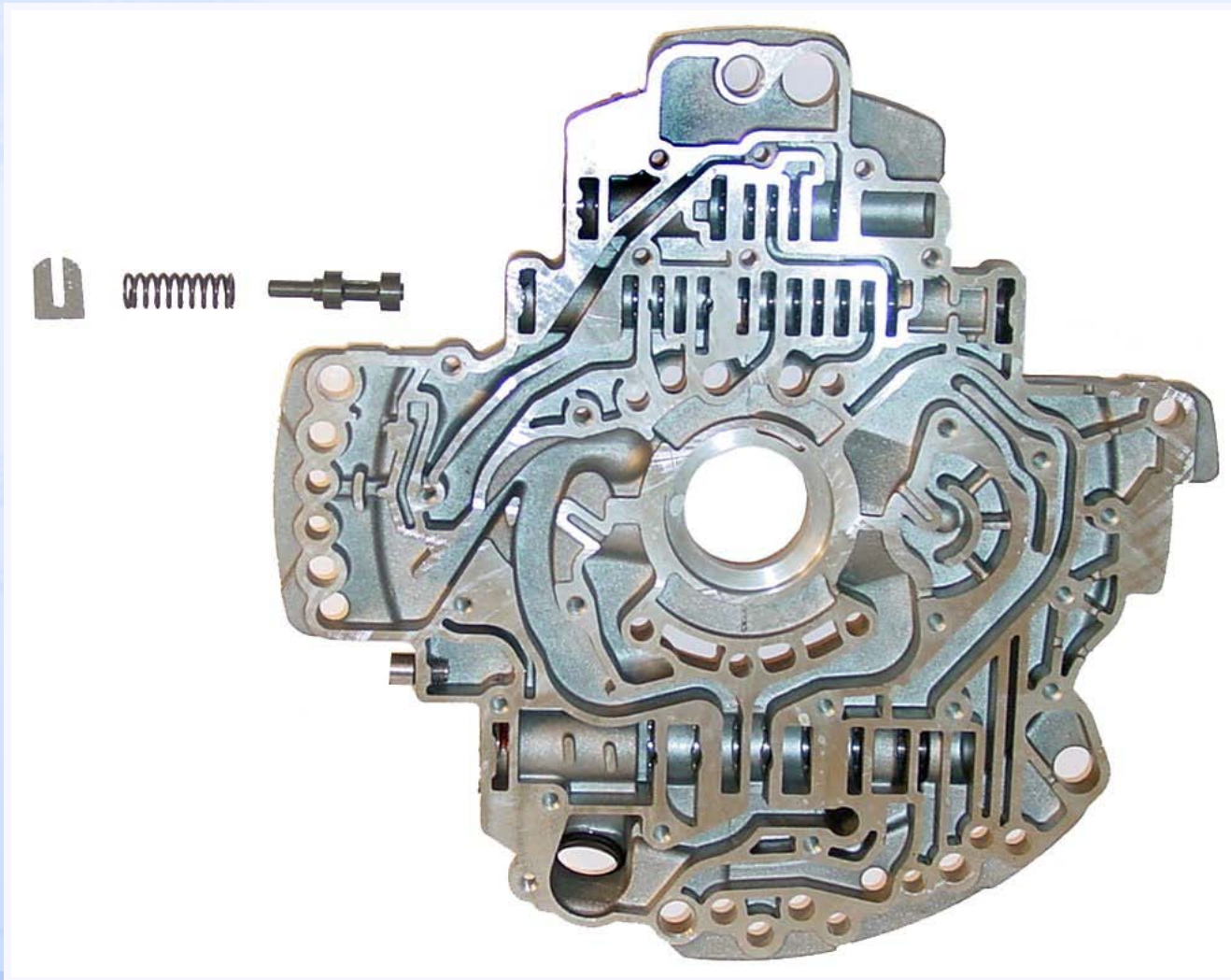

# Hydraulics

## Oil Pump - Valves

**Pressure Regulator Valve** – Controls the line pressure in the transmission. It is a balanced dump valve to maintain a fixed line value. With the use of the Line Pressure Solenoid the pressure can be lowered to a desired working value.

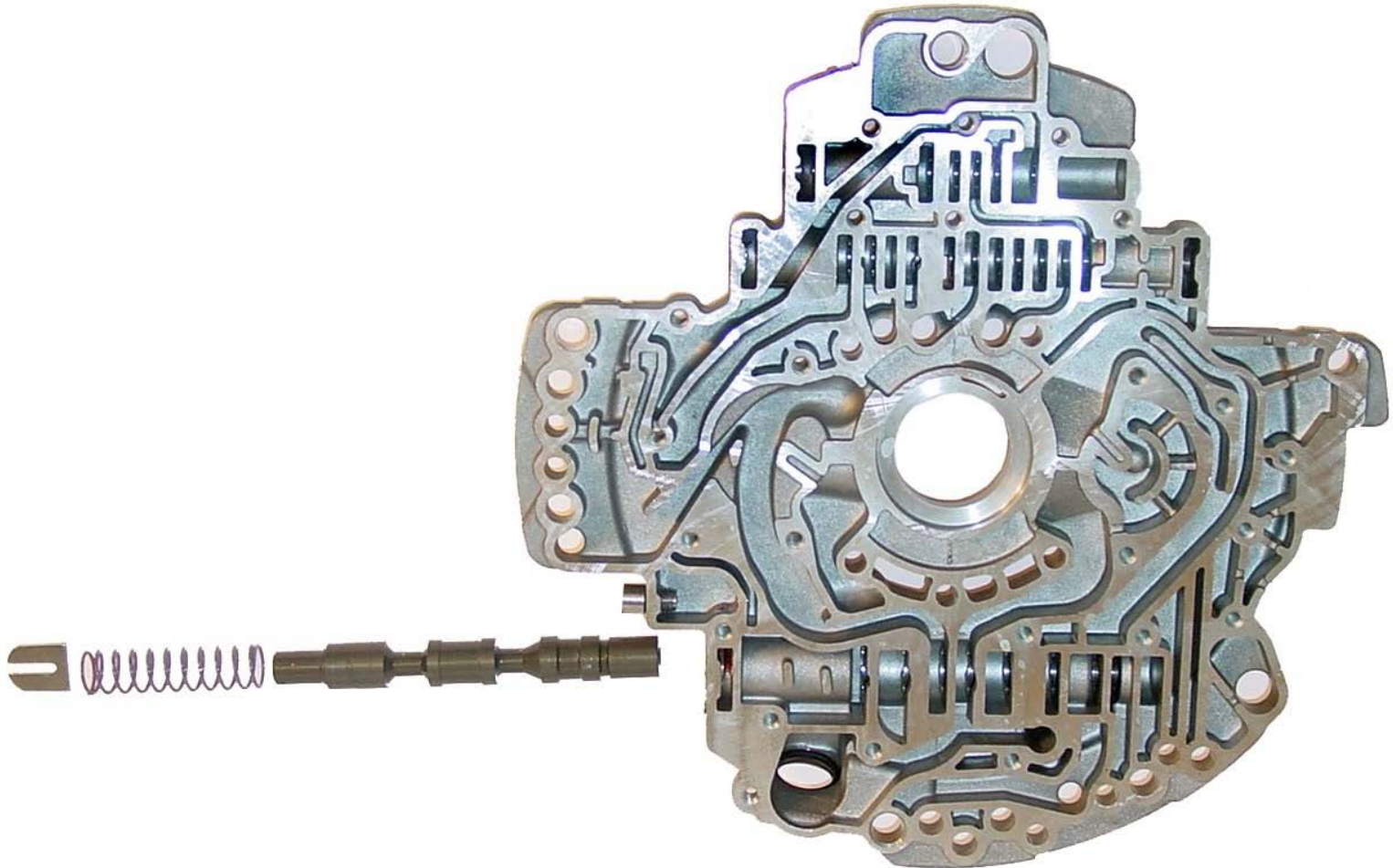

# Hydraulics Solenoid Body

## SOLENOID APPLICATION CHART

SHIFTER POSITION	GEAR	UD (NA)	OD (NV)	4C (NV)	2C (NV)	L/R (NV)	MS (NA)
P/N	P/N	OFF	OFF	OFF	OFF	ON ##	ON
R	R	OFF	OFF	OFF	OFF	OFF	OFF ++
OD	1 <sup>ST</sup>	OFF	OFF	OFF	OFF	ON **	ON
OD	2 <sup>ND</sup>	OFF	OFF	OFF	ON	OFF ^	ON
OD	3 <sup>RD</sup>	OFF	OFF	ON	OFF	OFF ^	ON
OD	4 <sup>TH</sup> >>	OFF	OFF	OFF	OFF	OFF ^	OFF
OD	5 <sup>TH</sup>	ON	OFF	ON	OFF	OFF ^	OFF
OD	6 <sup>TH</sup>	ON	ON	OFF	ON	OFF ^	ON
Manual Low or autostick 1st	1st	OFF	OFF	OFF	OFF	ON	ON
Manual 2nd	2 <sup>nd</sup> >>	OFF	OFF	OFF	OFF	OFF	OFF

>> = Failsafe is 4<sup>th</sup> gear, all solenoids off in OD range. Failsafe is 2<sup>nd</sup> gear if shifter is moved to manual 2-1 range

\*\* = On only from Neutral or Coast Down or in Manual 1. Off with Output RPM above 100. Off with kickdown to 1<sup>st</sup>. Off during extreme cold shift schedule.

## = Off if speed is over 8 mph (prevents engagement)

++ = On only if shift to Reverse is above 8 mph.

^ = Modulates for Convert Clutch EMCC



**Solenoid Resistance values:**  
**Line Pressure = 4.3 ohms**  
**All others = 1.9 ohms**



# Hydraulics

## Valve Body

Accumulators – 5 accumulators (L/R, OD, UD, 2C, and 4C) are used for clutch engagements. The inner spring in the 2C, 4C, UD, and OD accumulator is different on the 68RFE from the previous design RFEs. They are a spiral fit into the outer springs

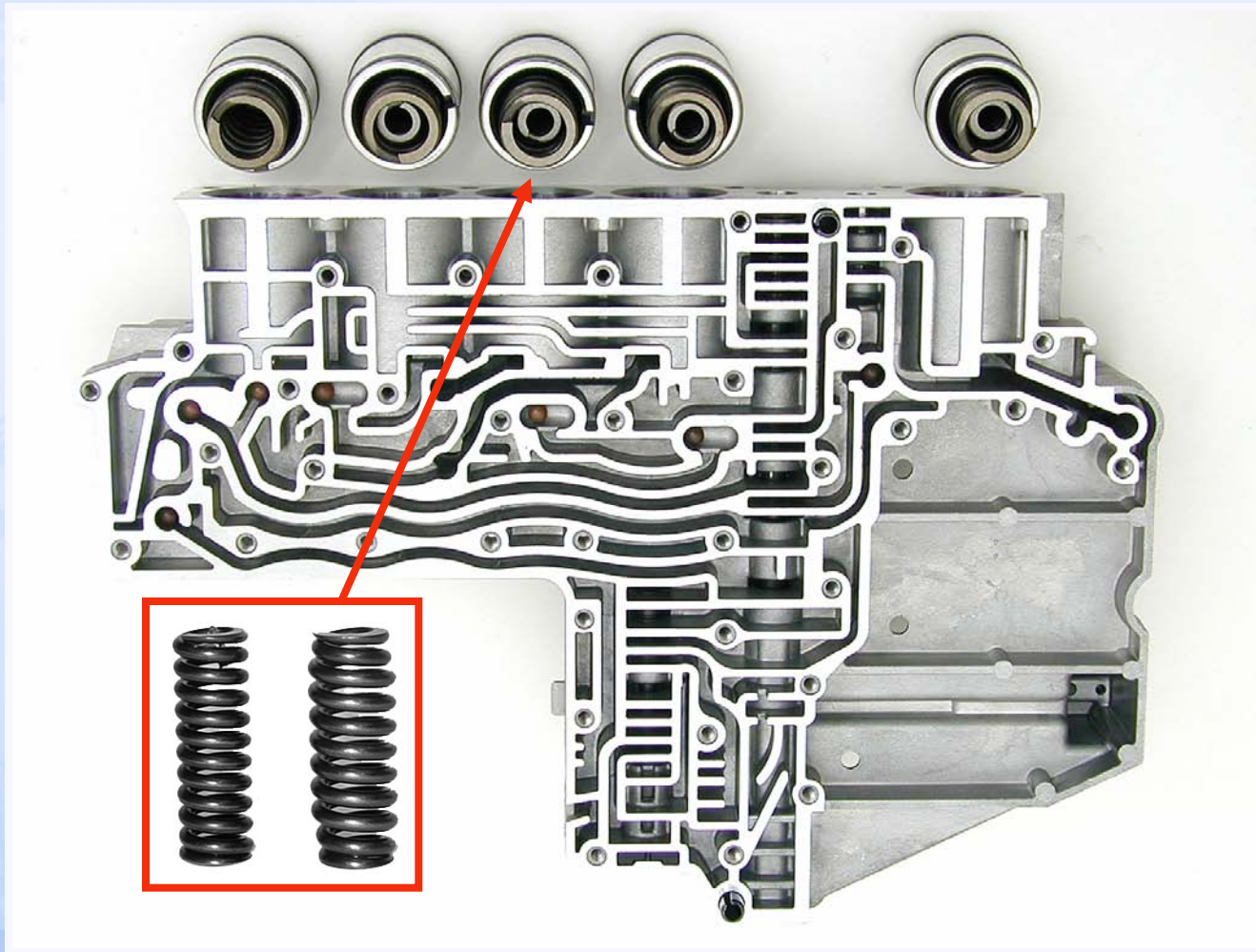

# Hydraulics Valve Body

**Separator Plate** – The separator plate on the 68RFE valve body is noticeably different. Note the notch on the outer edge.

545RFE

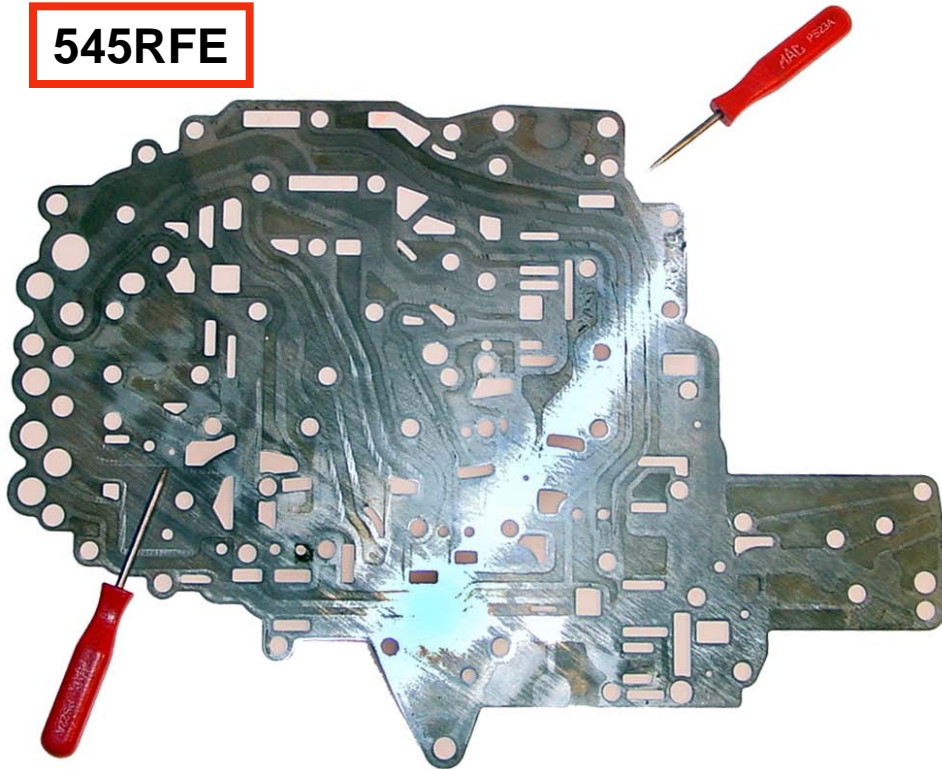

68RFE

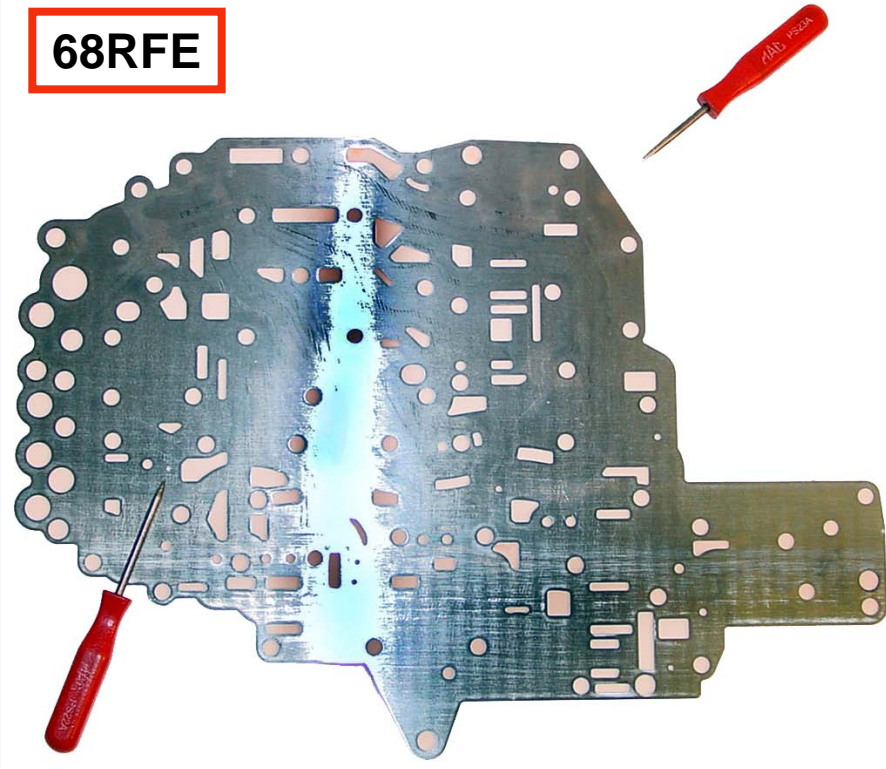



# Hydraulics Valve Body

**Main Valve Body** – Houses the Solenoid Switch Valve, the Low/Reverse Switch Valve, 5 Accumulators, and Manual Valve.

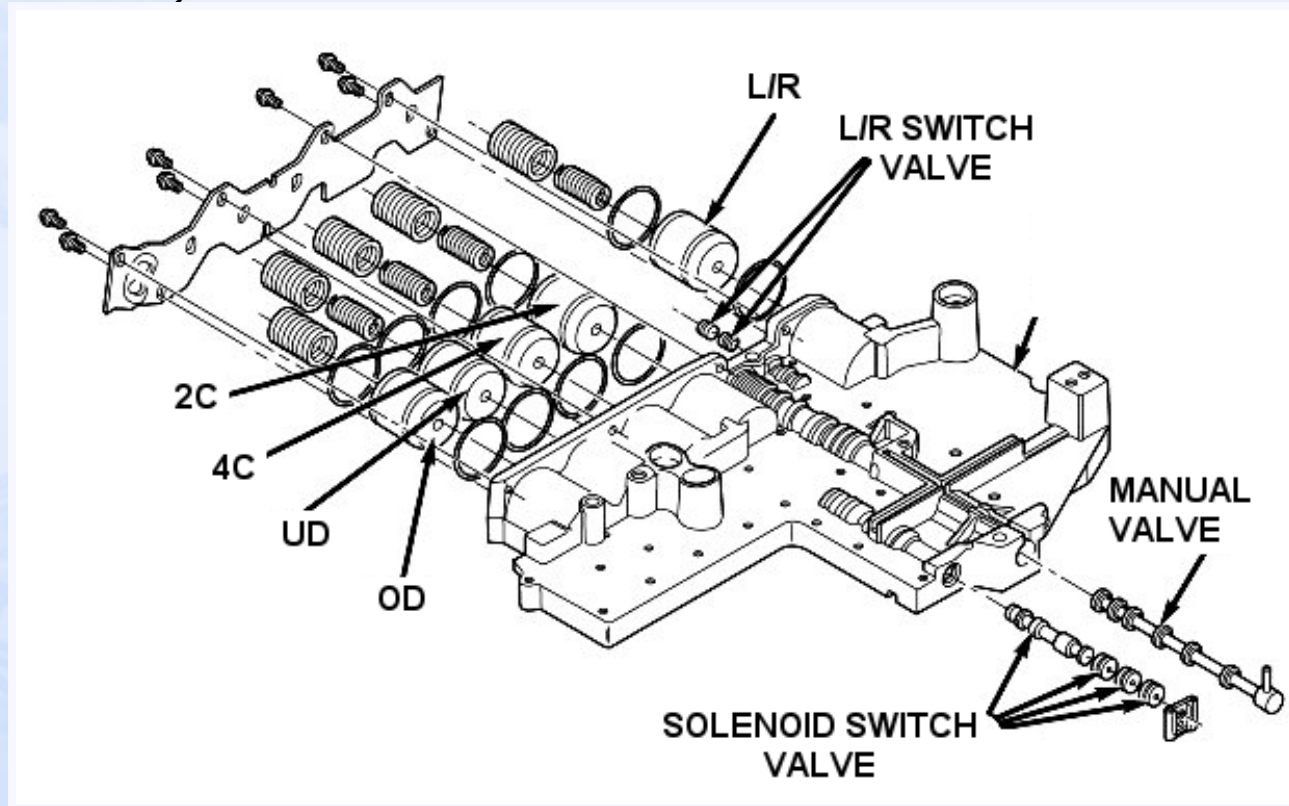

**Solenoid Switch Valve** – Controls fluid sent from the L/R solenoid for 1<sup>st</sup> gear apply and TCC apply depending on the position of the valve.

**L/R Switch Valve** – allows the Low/Reverse clutch to be operated by either the LR/CC solenoid or the MS Solenoid.

# Hydraulics Valve Body

**Check Balls** – There are 7 Check Balls used in the RFE transmission. Each one is important in preventing binding during the shifts.

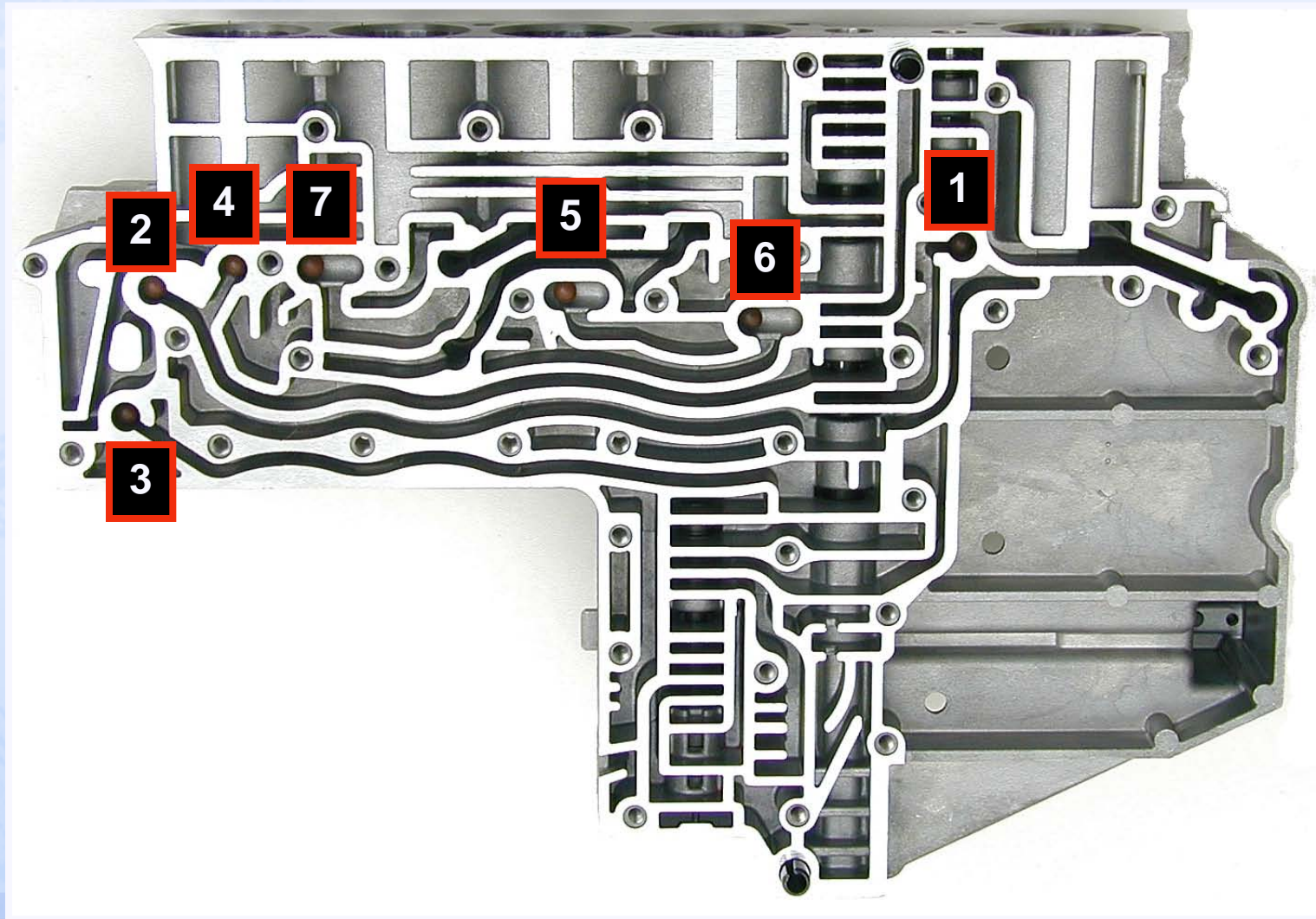



545/68RFE

Hardware  
Comparison



# Case

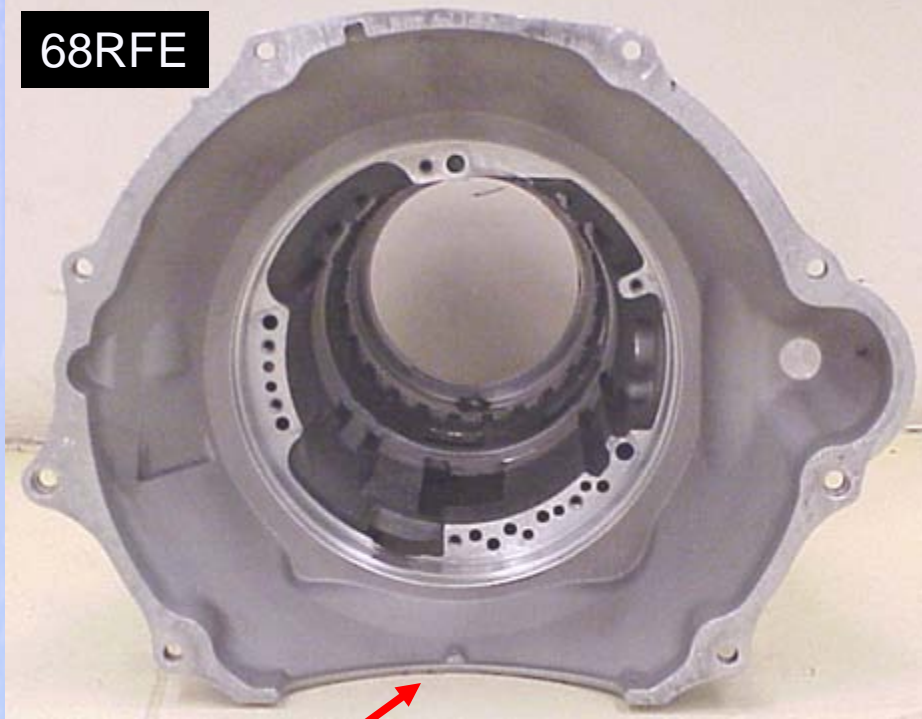

The case body for the 68RFE and the 45RFE are the same. The biggest difference is the 68RFE has a bigger bell. The bolt pattern on the bell is different on the 68RFE and it has a cutout for similar diesel application.

# L/R clutch pack

68RFE

14 single sided discs



An outer disc goes on the very bottom of the pack with the steel against piston. The discs are alternated for a total of 14 discs with an inner disc on top. All discs are installed with friction material up.

45RFE

6 plates & 6 discs

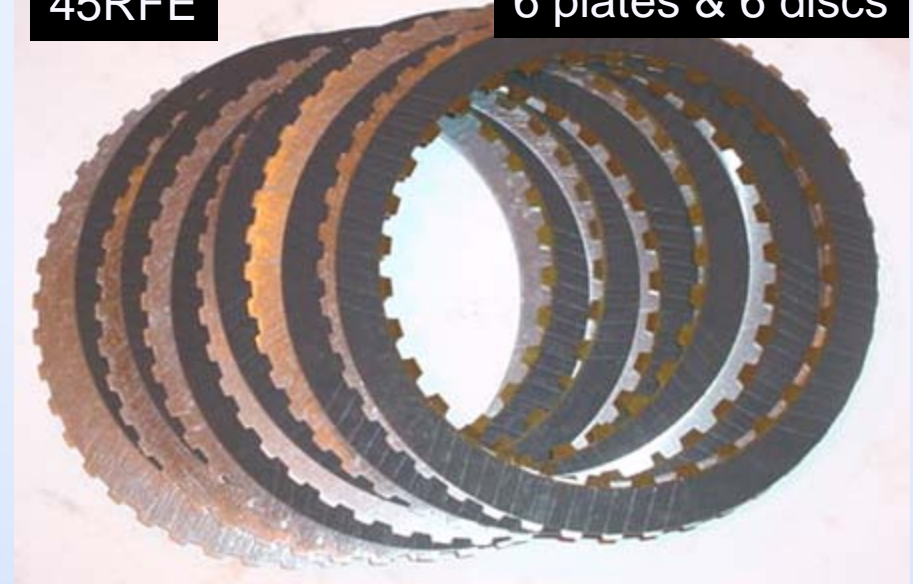

The 45RFE has six individual plates and discs. The steel plate (outer) goes on the bottom and the disc (inner) ends on top.

# L/R Reaction Plate

The reaction plate for the 68RFE has a step which gives clearance for the input annulus gear. It is installed with step facing upward.

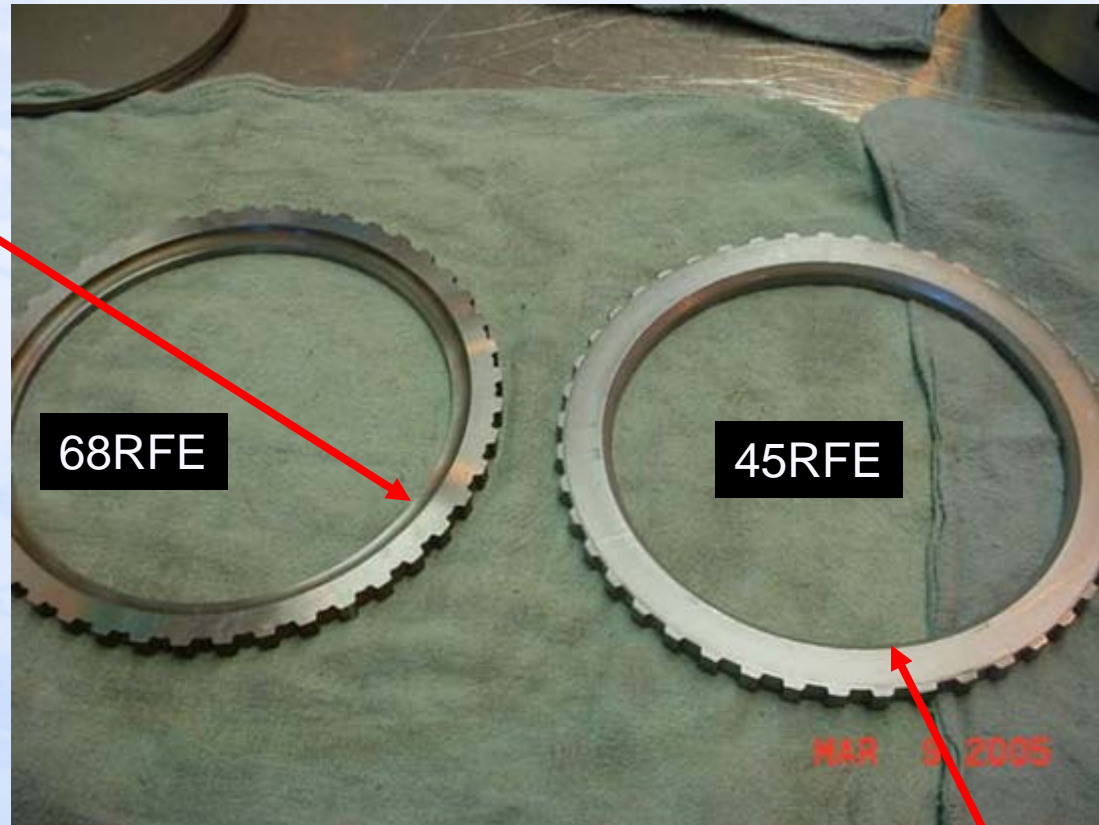

The reaction plate for the 45RFE does not have a step.



# New overrunning clutch (ORC)

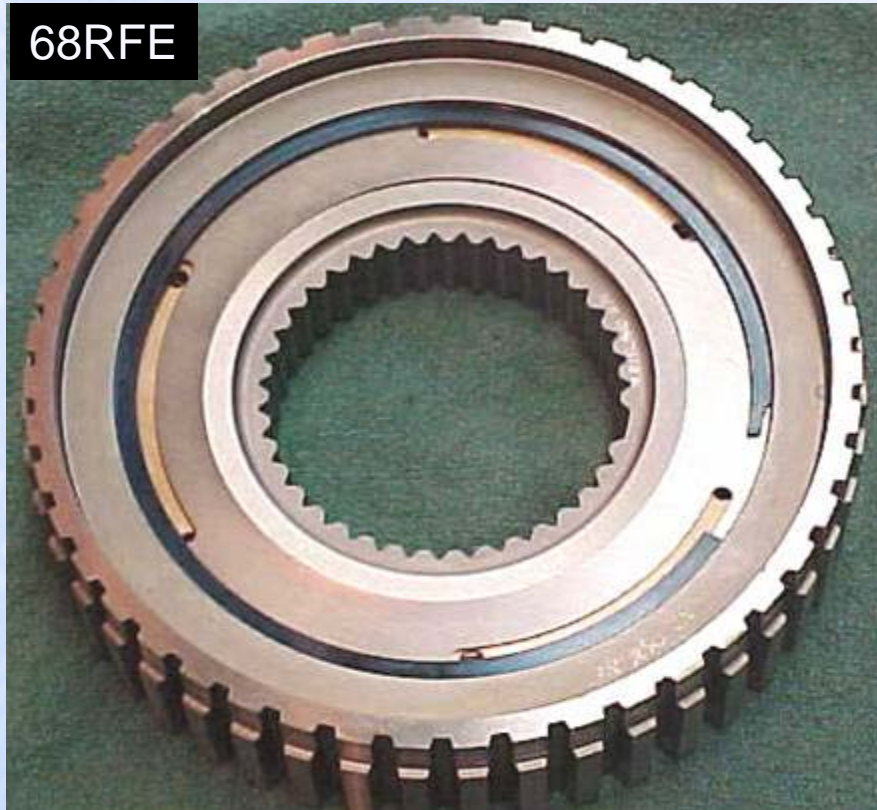

# L/R Assembly

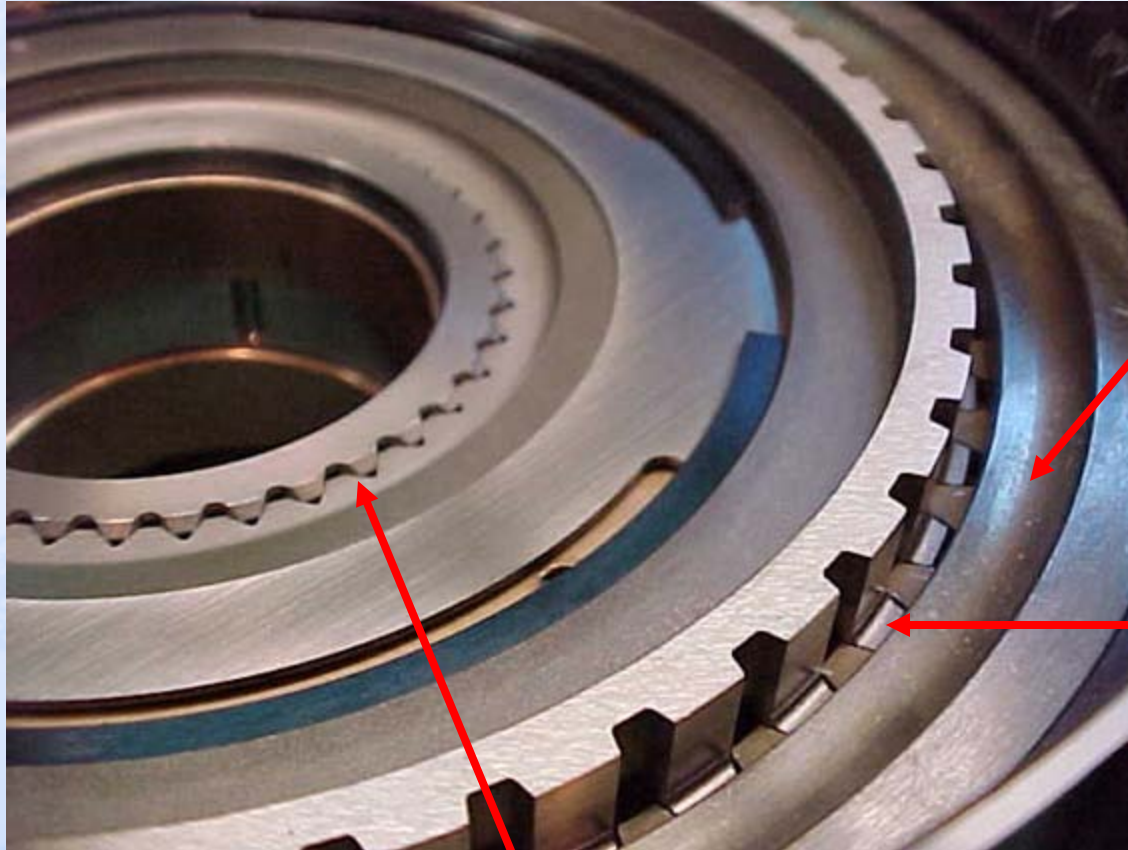

The reaction plate is installed with the step up.

Overrunning clutch is installed with the step up.

The overrunning clutch is seated when overrunning clutch is below the LR hub.



# Low/Reverse Subassembly

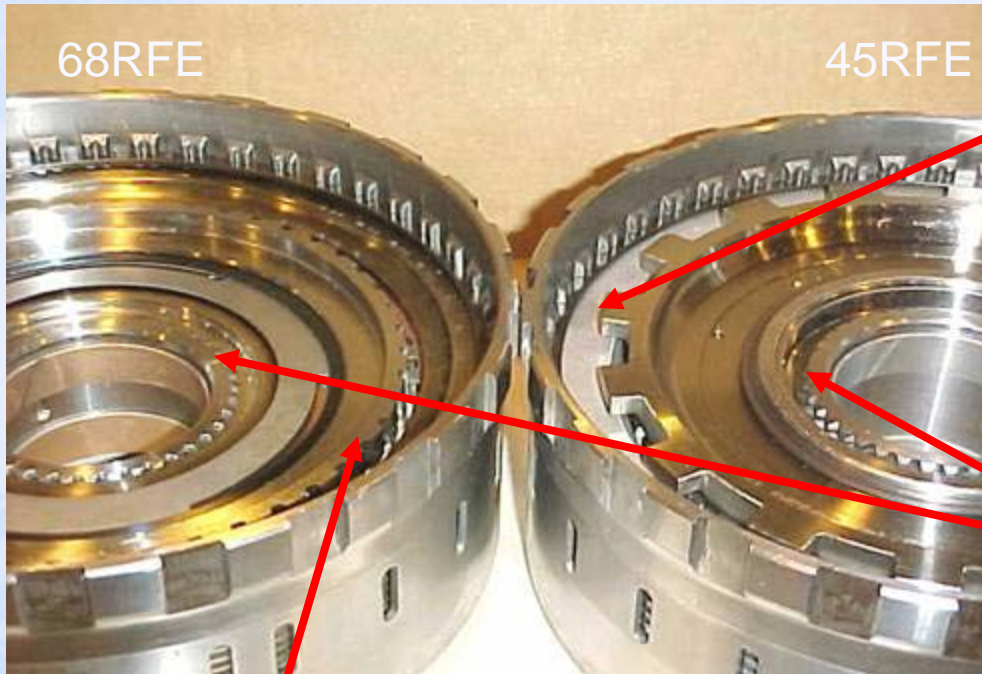

68RFE

45RFE

The teeth on the 45RFE overrunning clutch (ORC) stretch over the reaction plate. There is a snap ring that holds the ORC in place.

The center hub on the 45RFE is taller than the 68RFE.

The teeth on the 68RFE overrunning clutch (ORC) do not stretch out over the reaction plate. There is no snap ring to hold the ORC in place. Care must be taken when installing or removing the LR subassembly from the case.



# 2<sup>nd</sup> Clutch Piston

Oil grooves  
are square

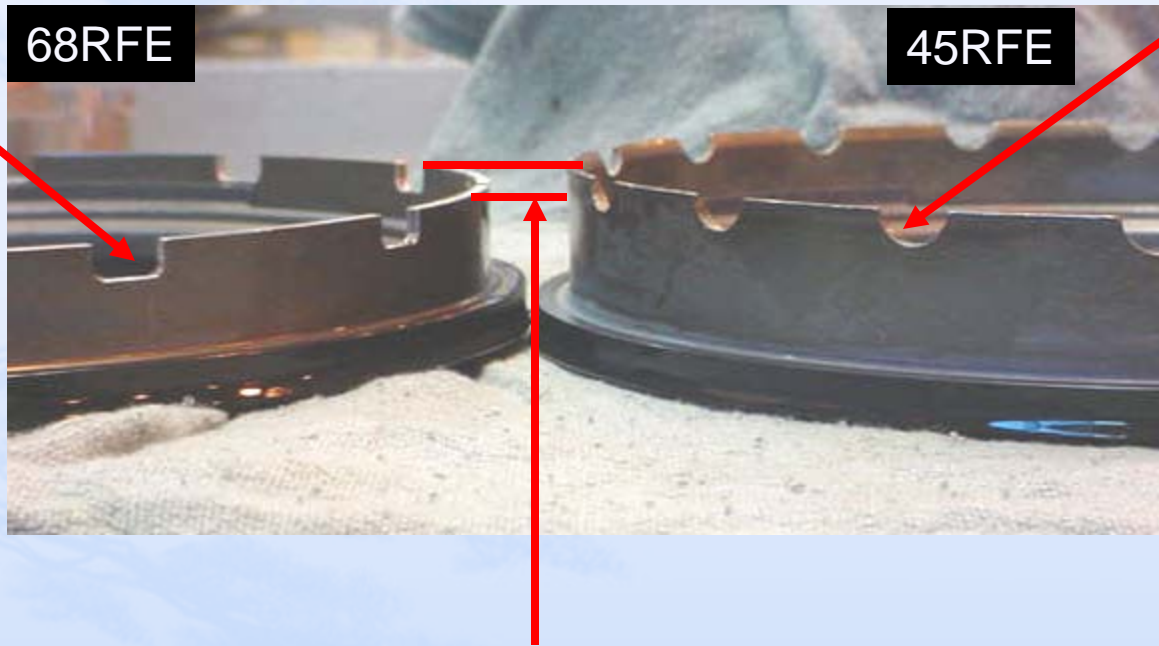

Oil grooves  
are circular

The 2<sup>nd</sup> clutch piston is 3mm shorter than the 45RFE.

# 2/4 Subassembly

Oil grooves  
are square.

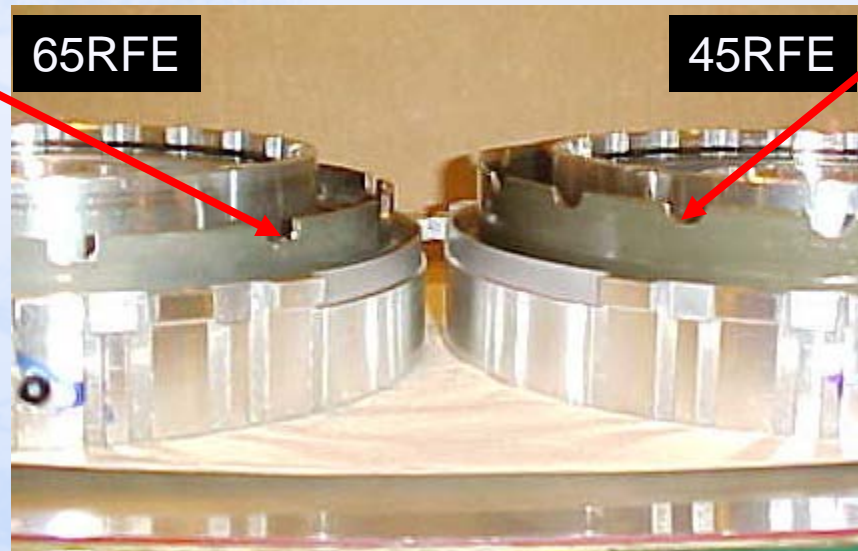

Oil grooves  
are rounded.

The 2<sup>nd</sup> piston on the 45RFE is 3mm taller than the 68RFE.

# Input Carrier

**New #12 bearing is thicker in the 68RFE than the 45RFE.**

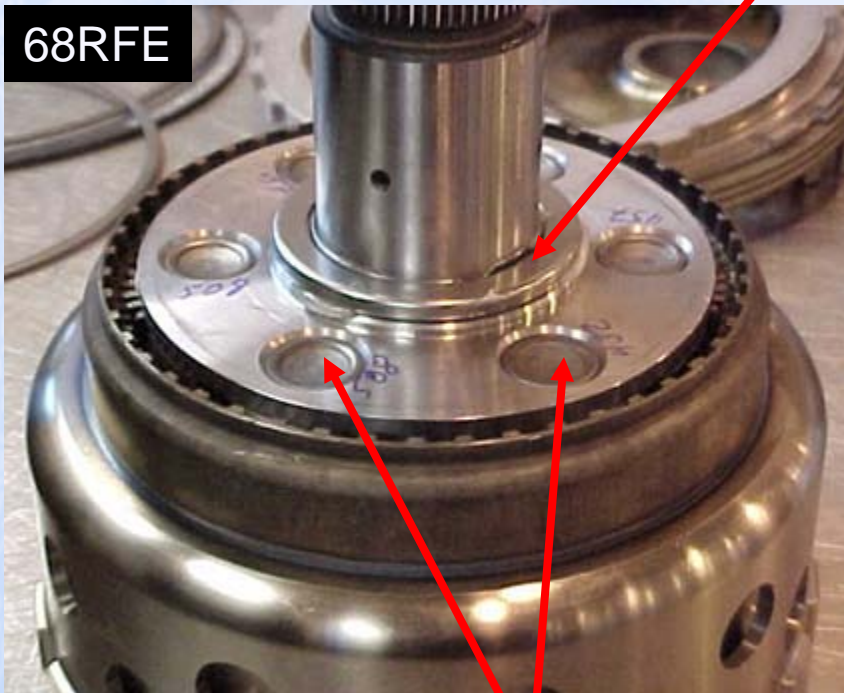

**The 68RFE has six pinions in input carrier.**

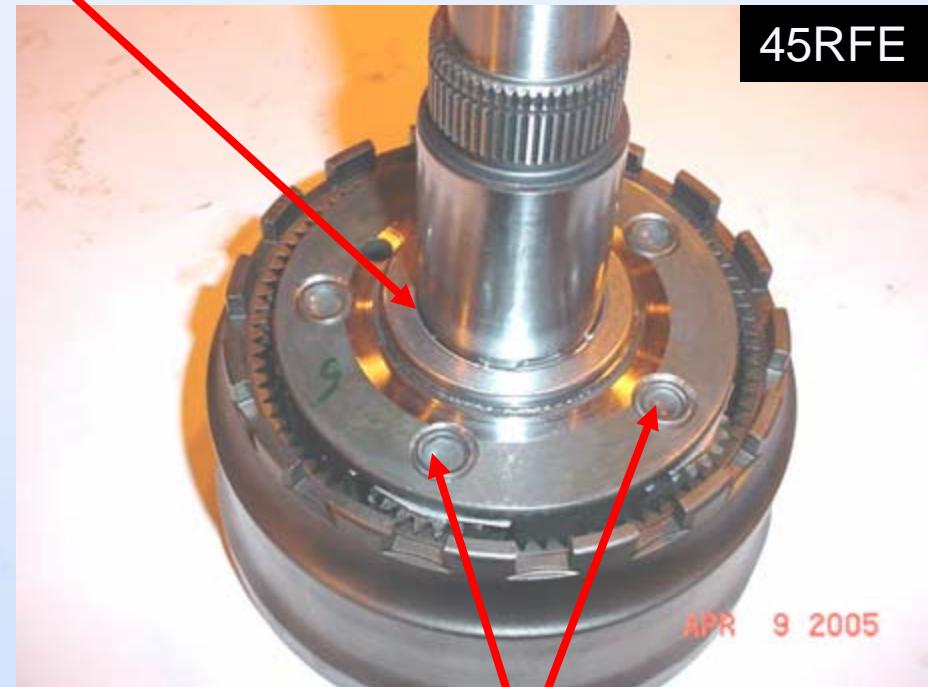

**The 45RFE has five pinions in the input carrier.**



# Input Carrier



**Input carrier**



**Input annulus**

# Reverse Carrier

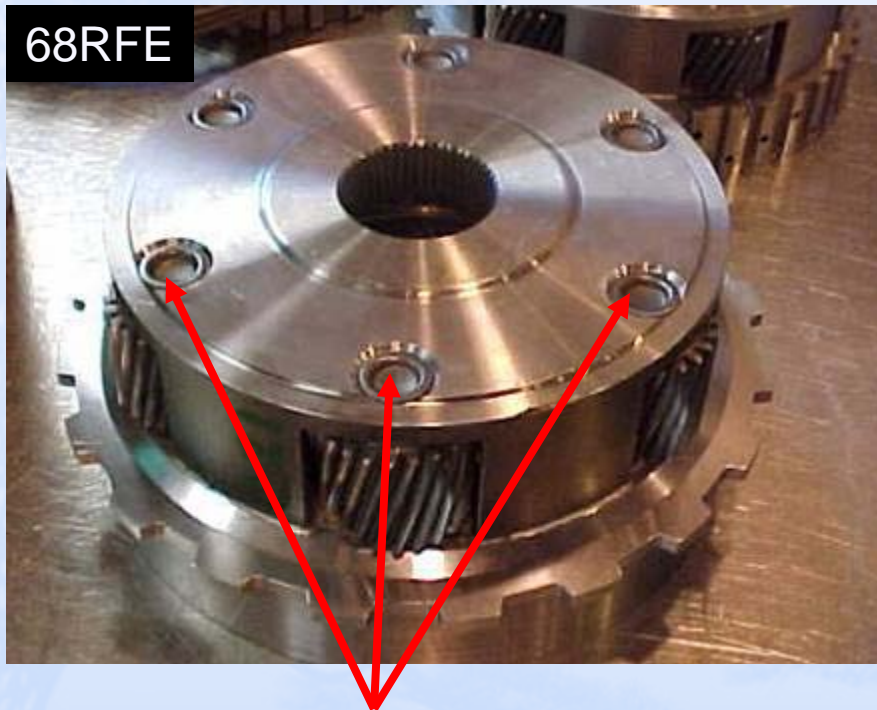

The reverse carrier for the 68RFE has six pinions. The reaction annulus is welded to the reverse carrier and it does not have a hub like the 45RFE.

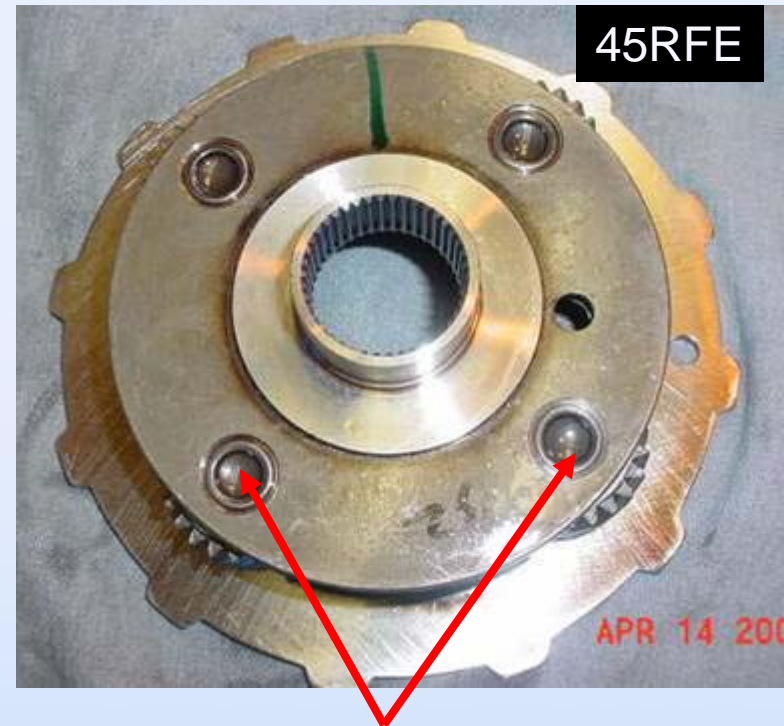

The reverse carrier for the 45RFE has four pinions. The reaction annulus is welded to the 4C hub on the 45RFE.



# Reaction Carrier

68RFE

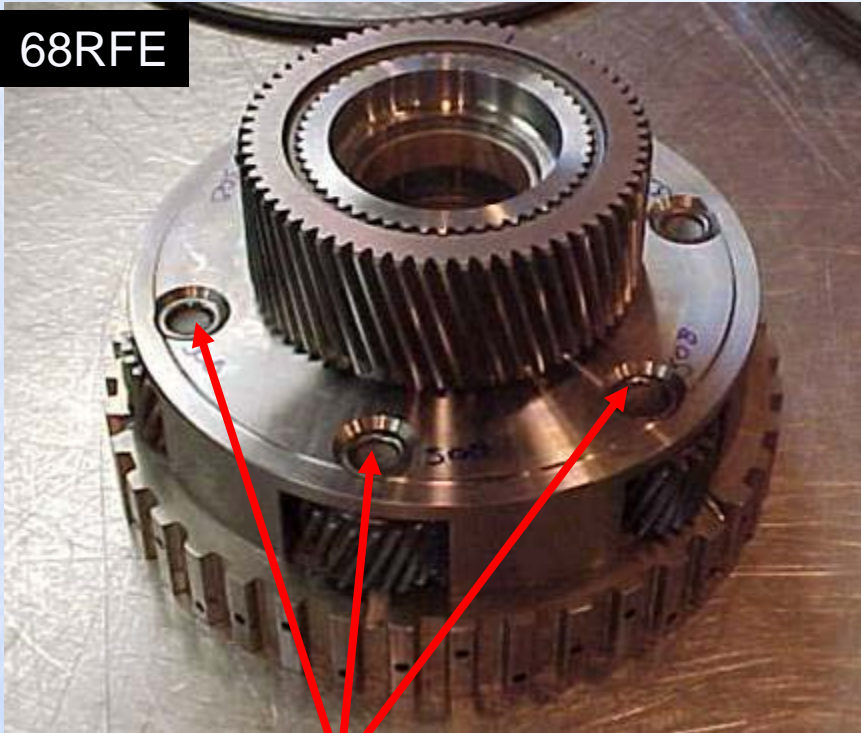

The 68RFE reaction carrier has six pinions.

45RFE

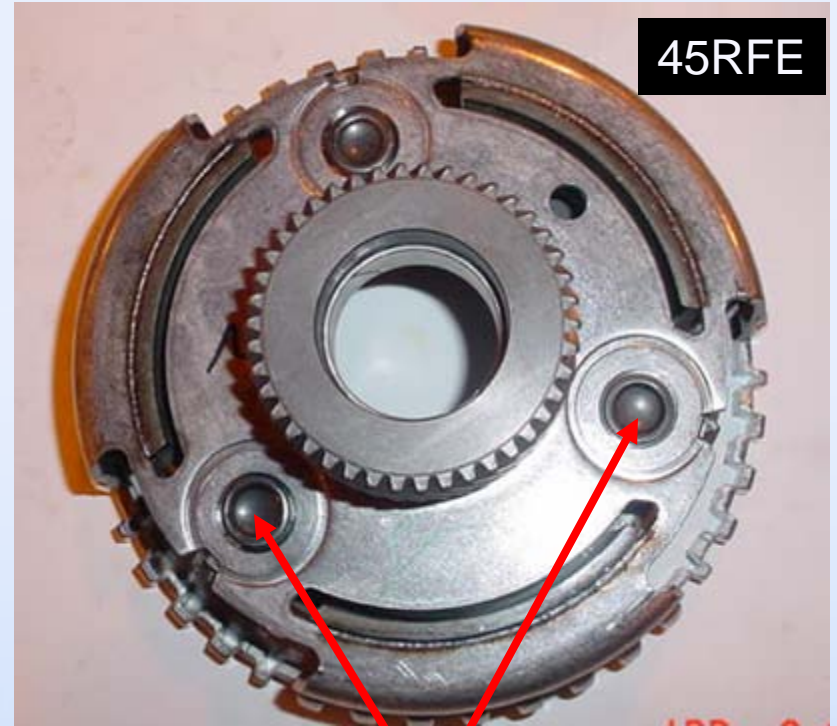

The 45RFE reaction carrier has three pinions.



# Reaction Sun Gear



#8 bearing part number 4799469.

# 8 bearing on bottom of gear.

# 7 bearing on top of gear.

45RFE

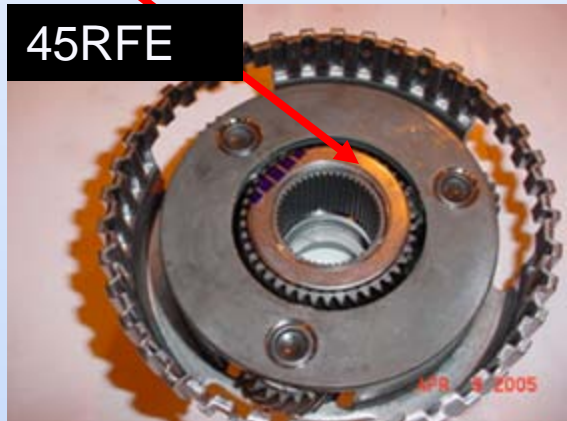

On the 68RFE reaction sun gear is welded to the 4C hub. The #8 bearing will be greased and installed with blue stripe facing the reaction sun gear. The #7 bearing has been eliminated in the 68RFE.

# 4<sup>th</sup> Clutch Hub

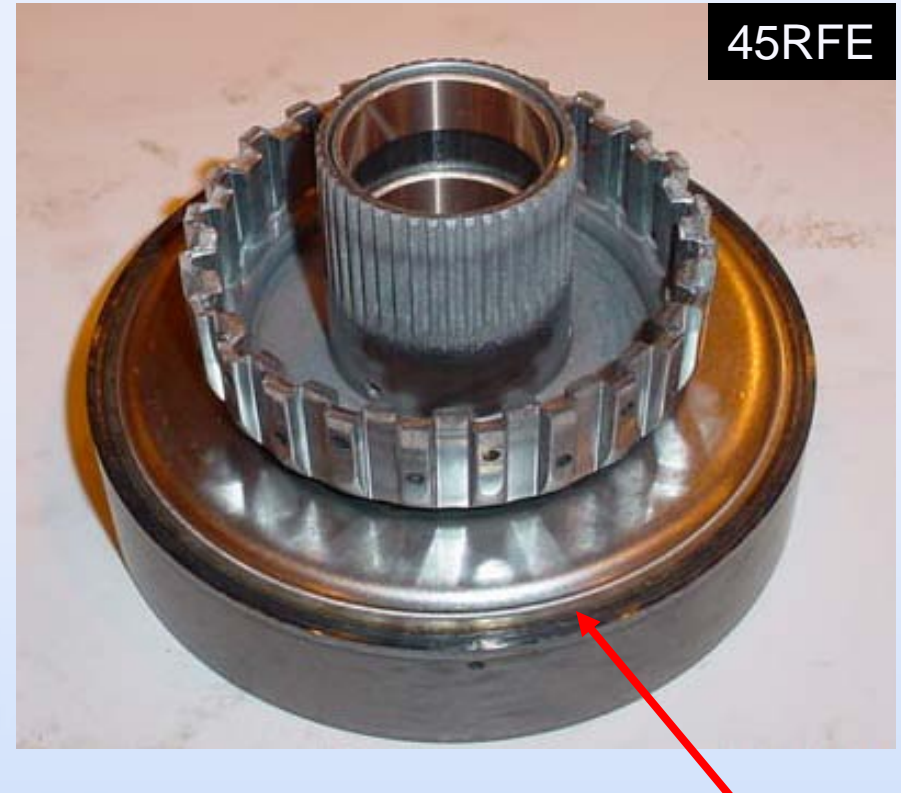
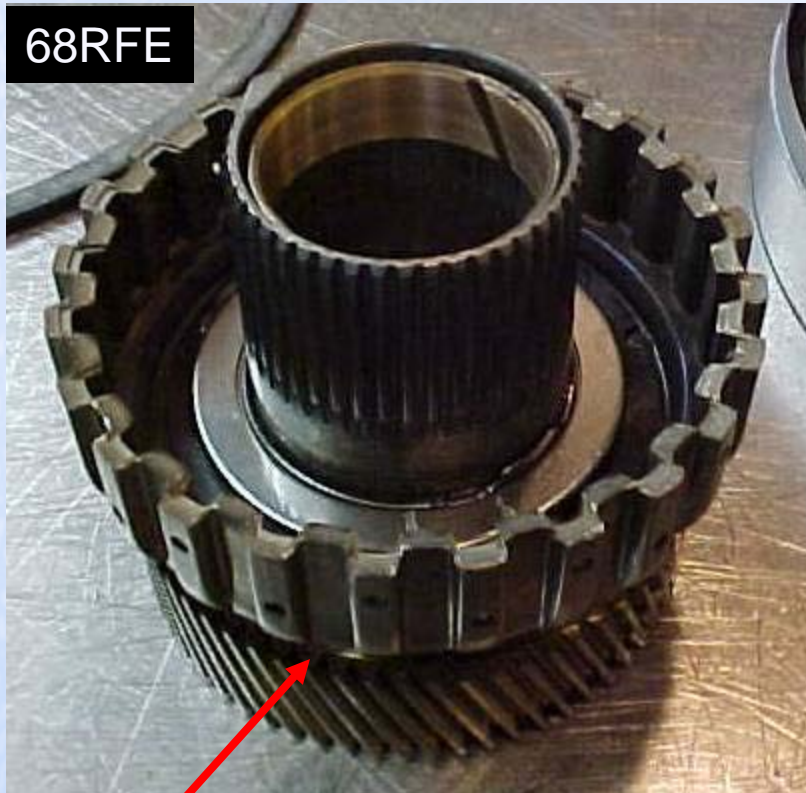

**Reaction sun gear is welded to the 4C hub. Reaction annulus is welded to 4C hub.**

**The thrust washer and bearing are the same for the 45RFE and 68RFE.**

# Input Clutch Assembly



The 68RFE input shaft is taller and the diameter is larger than the 45RFE. It also has blue Torlon seals on the shaft and the 45RFE has white Teflon seals.



# Input Clutch Assembly

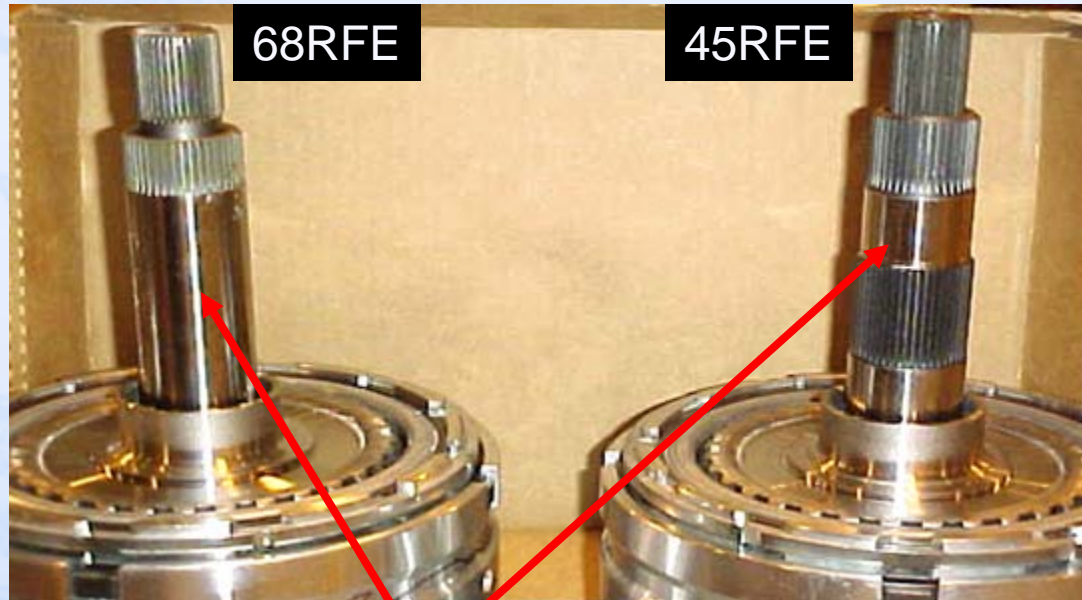

The 68RFE overdrive shaft has one set of splines. The 45RFE shaft has two sets of splines.

# Input Shaft

The 68RFE input shaft is taller, has a larger outer diameter, and does not have a polished journal below the top spline.



# Reverse/OD Piston Belleville Spring

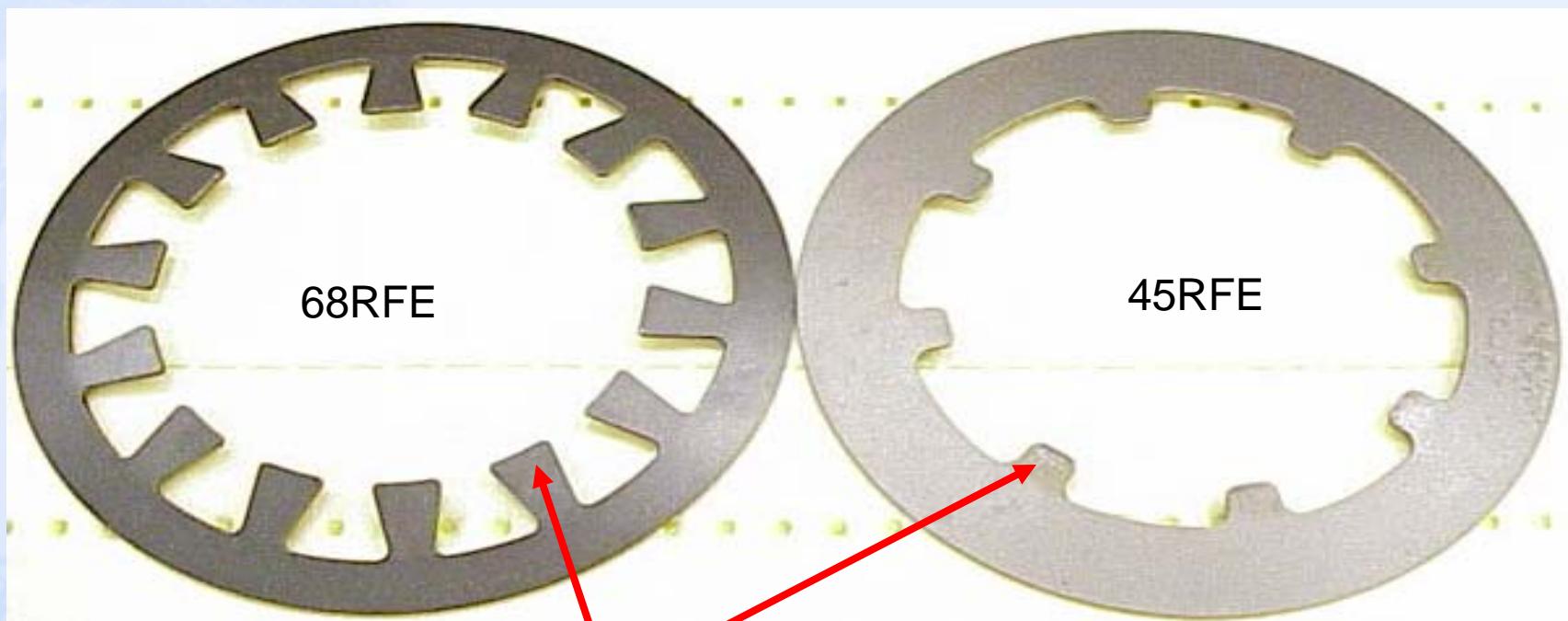

The belleville spring for the 68RFE has 14 fingers and the 45RFE has 8 fingers.



# Underdrive (UD) Shaft

68RFE

45RFE

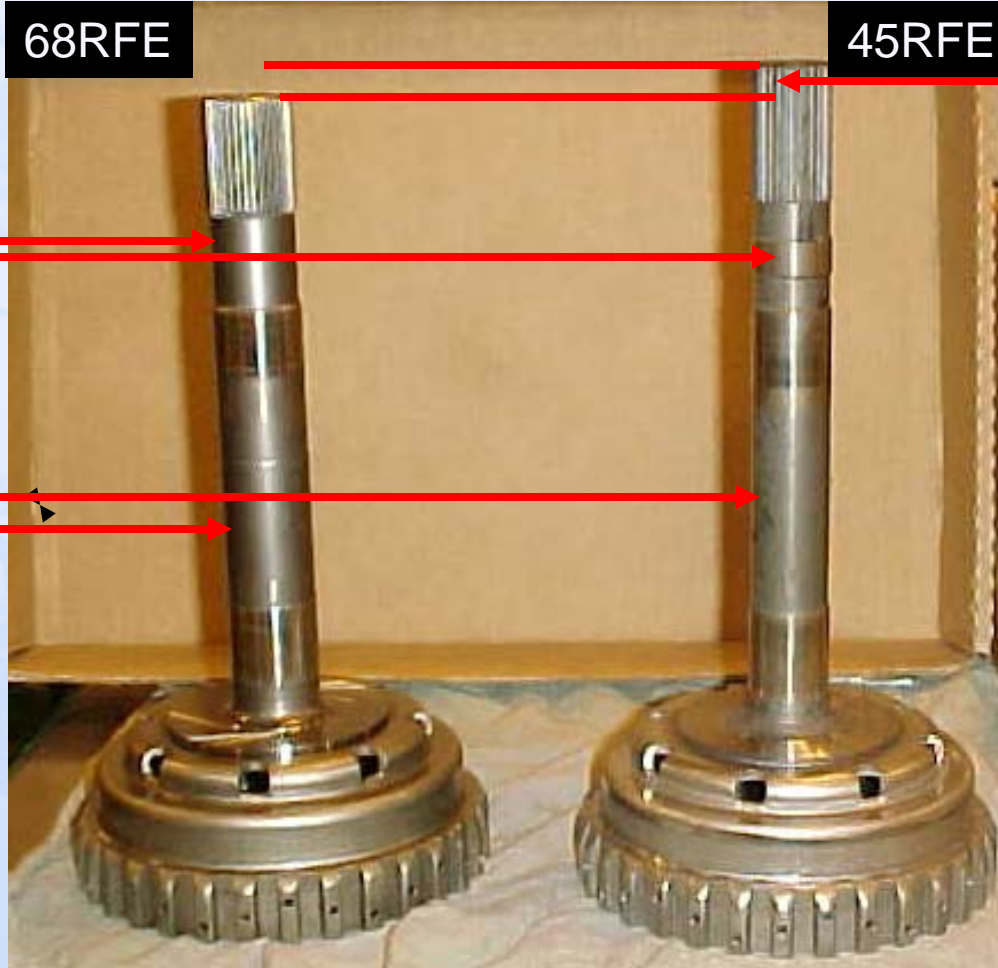

The top journal has been eliminated on 68RFE.

The 68RFE shaft has a larger outer diameter than the 45RFE.

The 45RFE UD shaft is slightly taller than the 68RFE.

# UD Clutch Pack

68RFE

10 single sided discs



The outer disc goes on the bottom and are alternated between inner and outer for a total of 10 discs. The inner disc is on top. The clutch pack is installed with the friction material facing up.

45RFE

4 discs & 4 plates



The steel plate starts on the bottom and the plates and discs are alternated for a total of four each. The disc is on top.

# UD/OD Reaction Plate

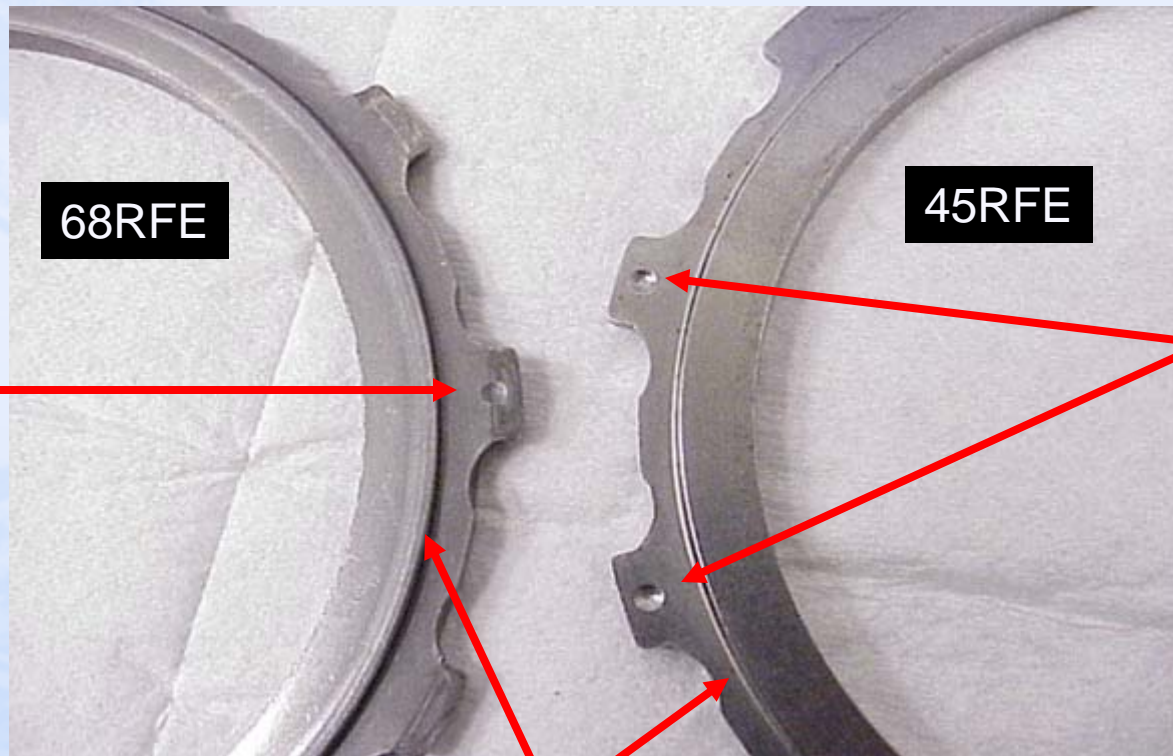

68RFE has one dimple.

45RFE has two dimples.

**The step on the new UD/OD reaction plate for 68RFE is larger than the 45RFE. The plate should be installed with step and dimples facing upward.**



# Orientation of UD/OD reaction plate

The reaction plate for both the 45RFE and 68RFE are installed with dimples and step facing upward.

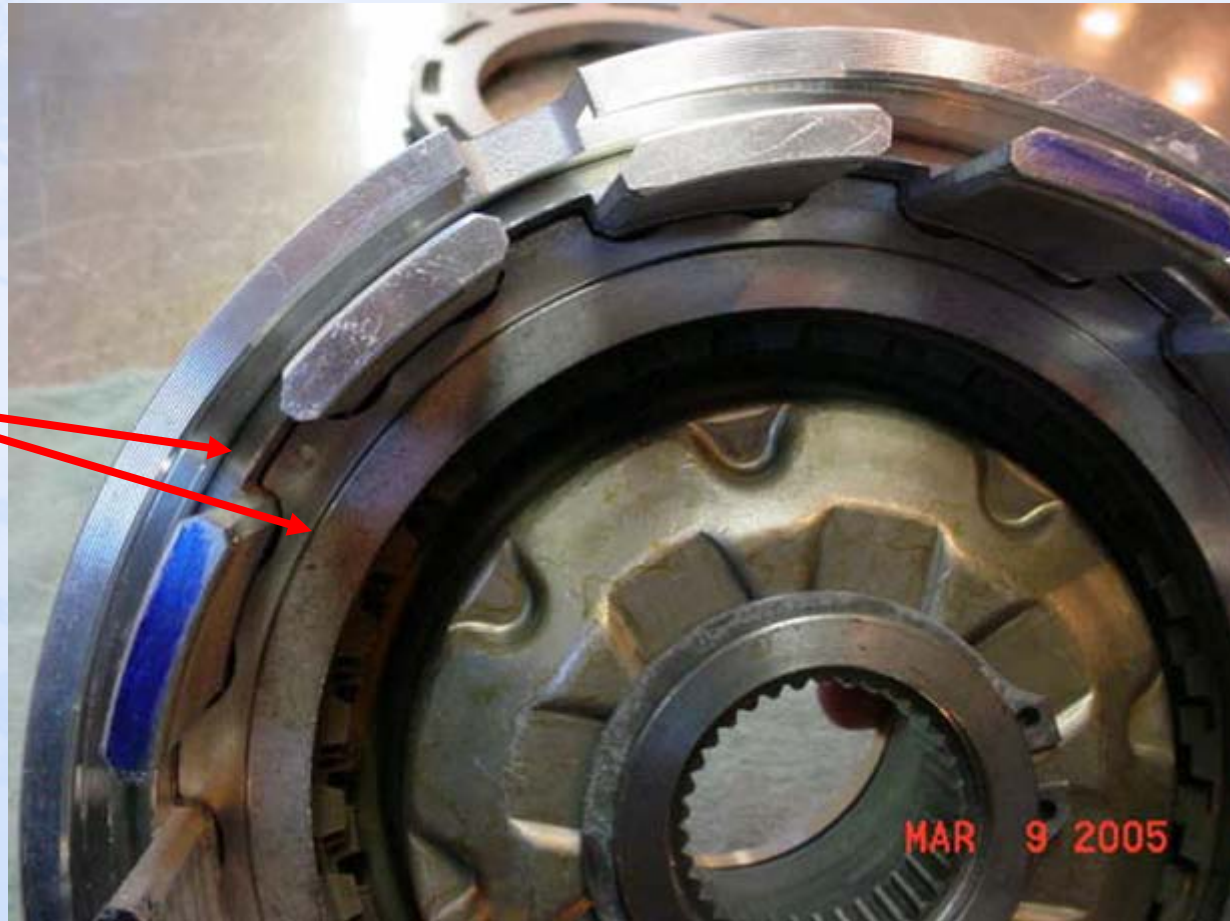

# Overdrive (OD) Shaft

The 68RFE overdrive shaft has one set of splines and the 45RFE has two sets of splines. The 68RFE has three lube holes on the shaft and the 45RFE has four. Also, the 45RFE is slightly taller than the 68RFE.

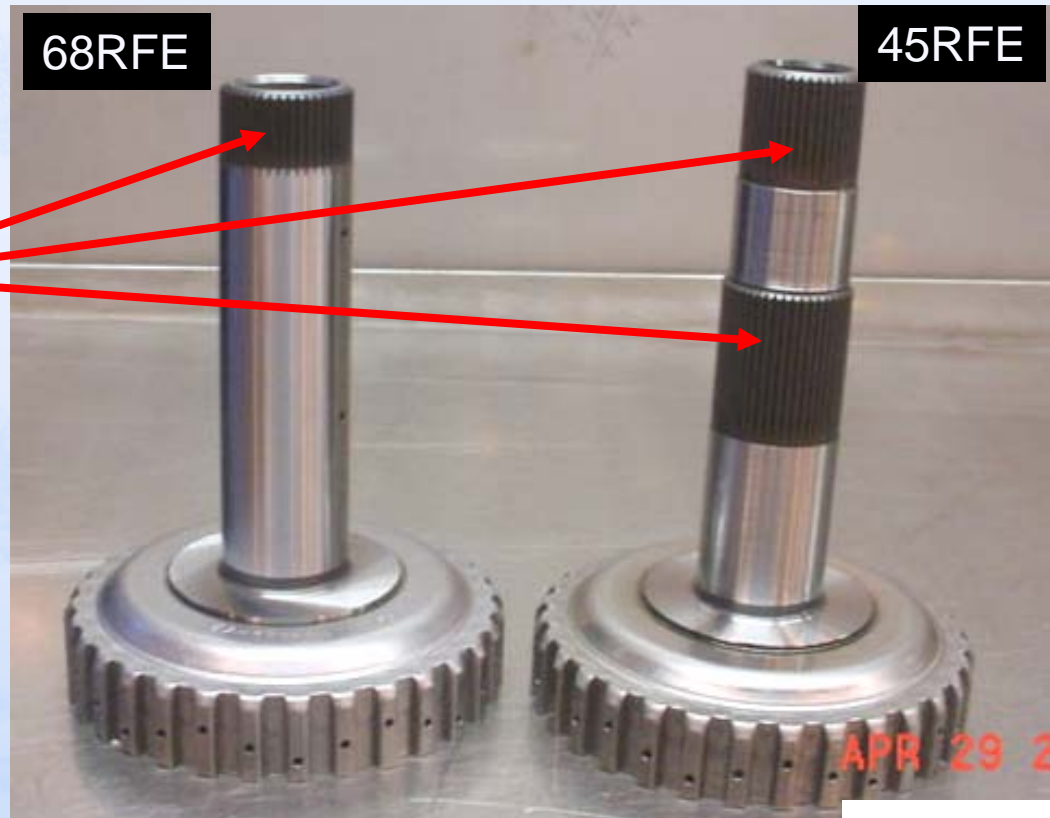

# OD Clutch Pack

68RFE

12 single sided discs

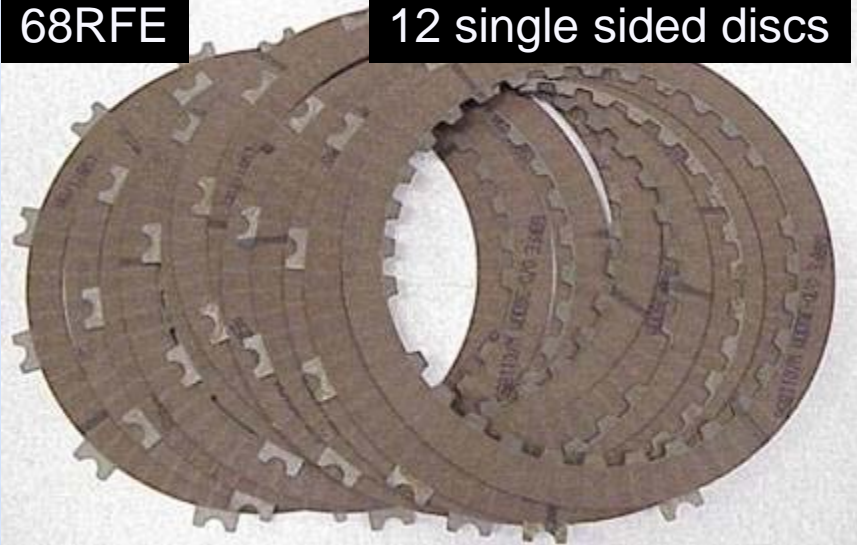

The outer disc goes on the bottom and are alternated between outer and inner for a total of 12 discs. The inner disc is on top. The plates are installed with the fiber facing upward.

45RFE

3 plates & 4 discs

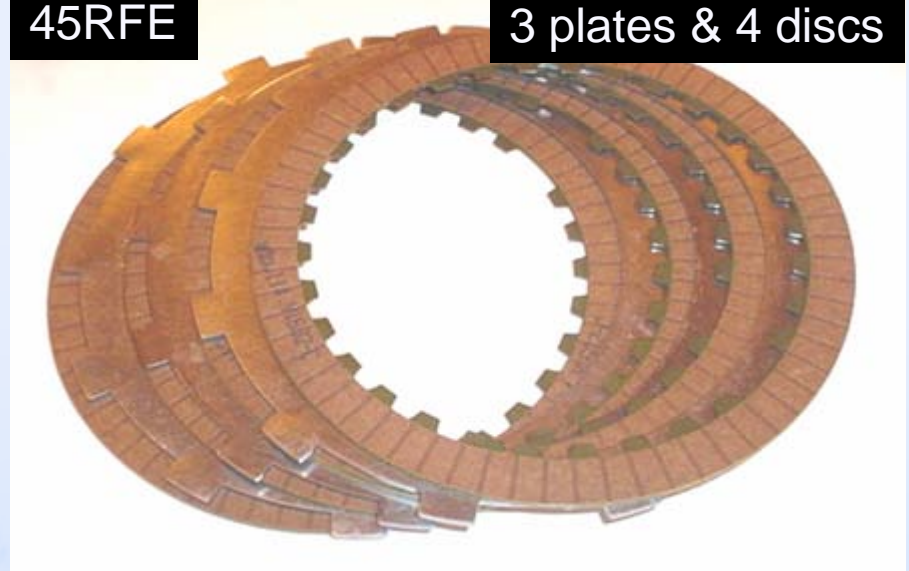

The disc starts on the bottom and the plates and discs are alternated for a total of four discs and three plates. The disc is on top.



# OD Pressure Plate

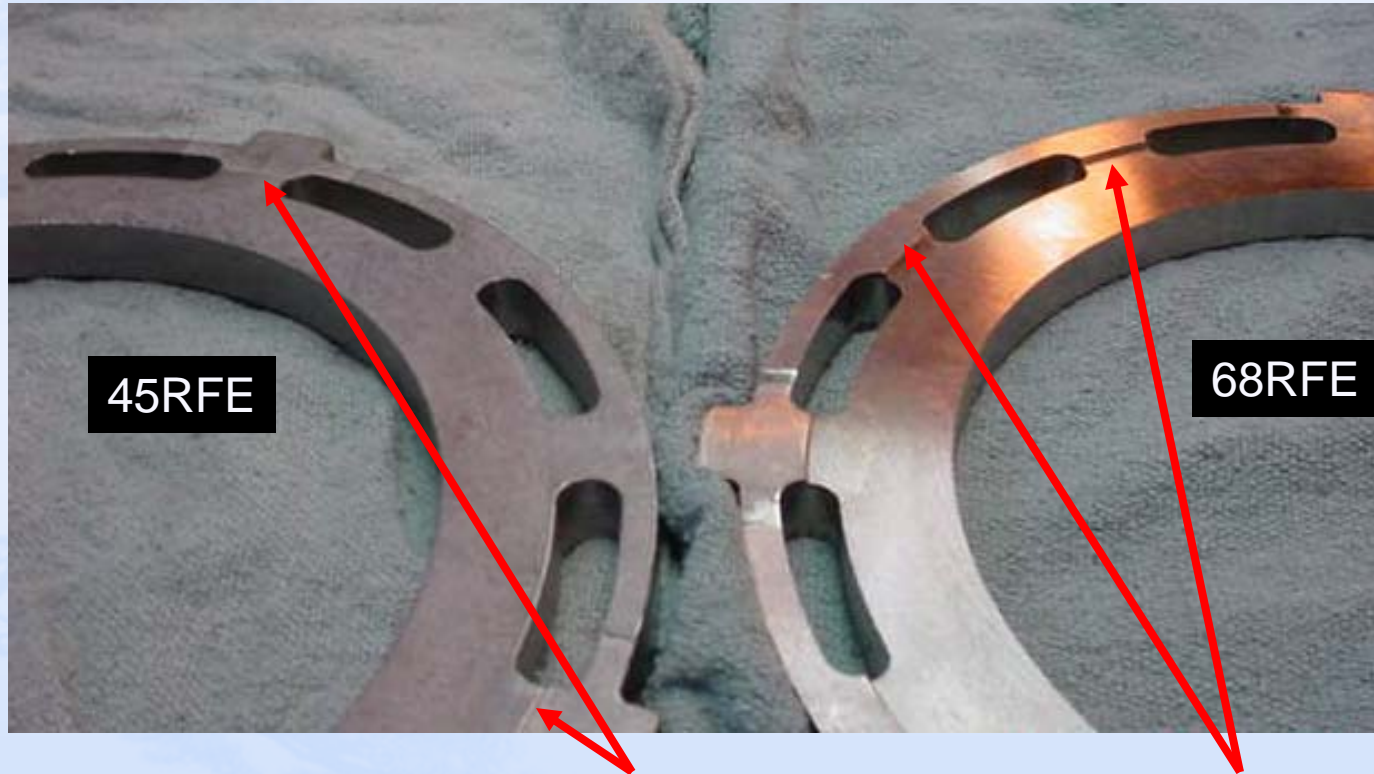

**The 68RFE has a protruding step around the entire face of the part. The 45RFE only has steps on the teeth. The 68RFE pressure plate is installed with the step down (facing OD clutch pack). The 68RFE will have three selections for the pressure plate.**

# OD Pressure Plate

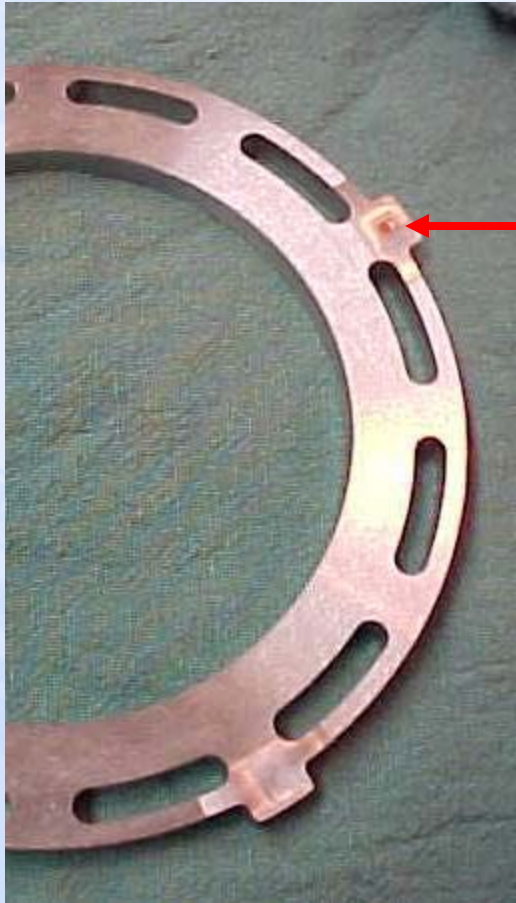

**68RFE pressure plate is installed properly when the identification number of 1 or 2 is facing up and the step is down.**

# 2<sup>nd</sup> Clutch Pack

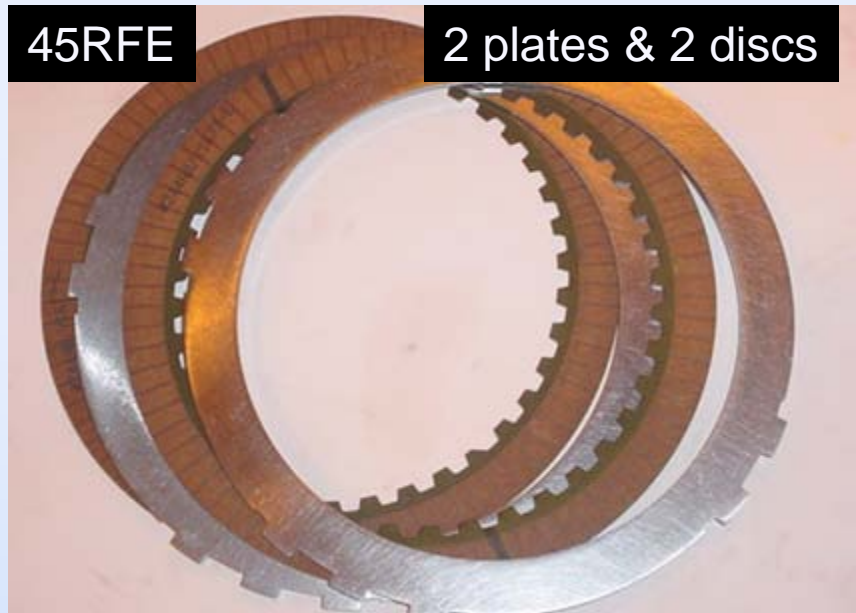
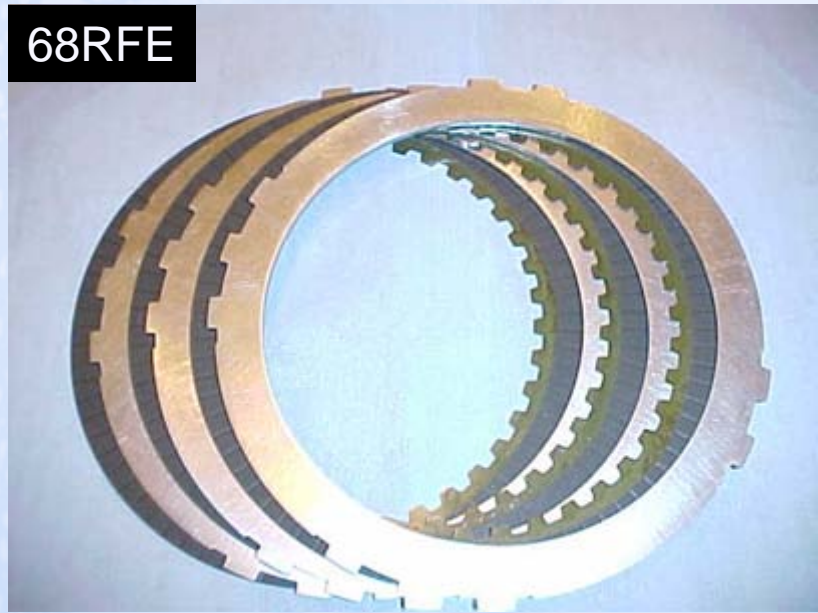

The 68RFE uses the same discs and plates for the 2<sup>nd</sup> clutch pack as the 45RFE. The only difference is that the 68RFE has an additional disc and plate.



# Reverse Hub and Shaft



The 68RFE is not two pieces welded together. It is a one piece part.

The 45RFE is two pieces welded together and the weld can be seen on the back of the 45RFE part.

# Reaction Shaft Support (RSS)

The RSS for the 68RFE is taller than the 45RFE. The inner and outer diameter of the shaft is larger on the 68RFE.



# Reaction (Stator) Shaft Support (RSS)

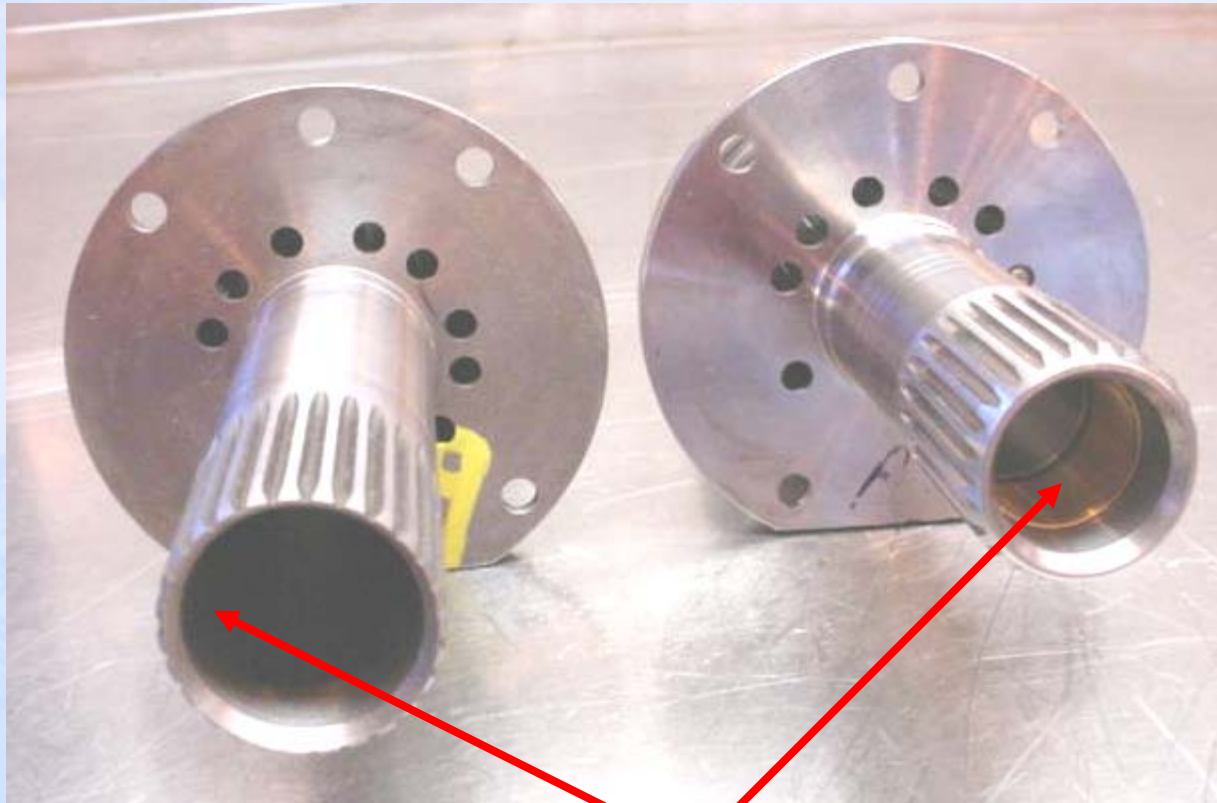

The 68RFE does not have a bushing at the top of the shaft.



# 2C Accumulator Spring

68RFE



45RFE



Inside the valvebody the 68RFE has a green inner spring on the 2C accumulator spring. The 45RFE is the same color as the outer spring.

# OD Accumulator Spring

68RFE



45RFE



Inside the valvebody the 68RFE has a purple OD accumulator spring. The 45RFE has a black or dark colored spring.

# Main Valvebody Accumulator Springs

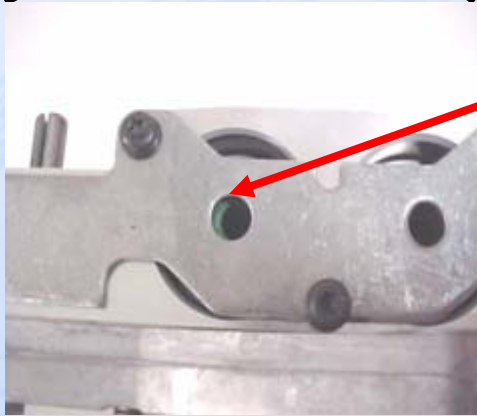
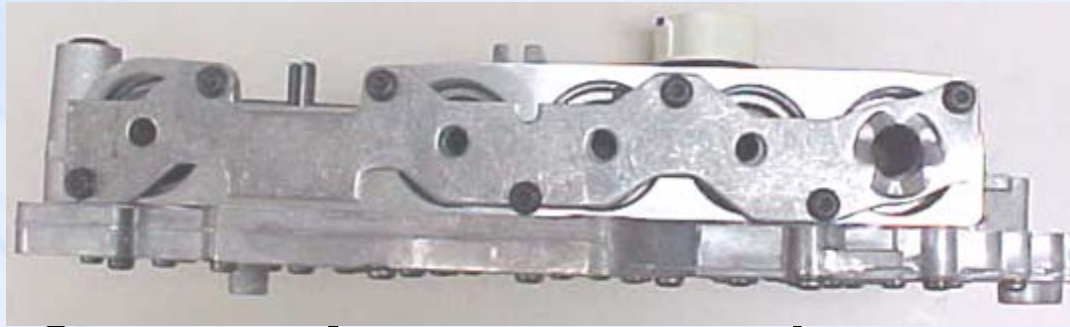

**Green 2C  
accumulator  
spring**

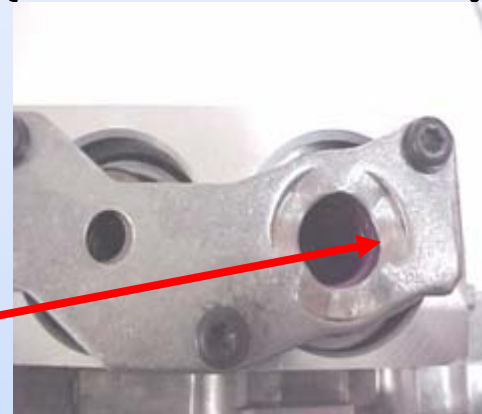

**Purple OD  
accumulator  
spring**



# Notched Manual Lever

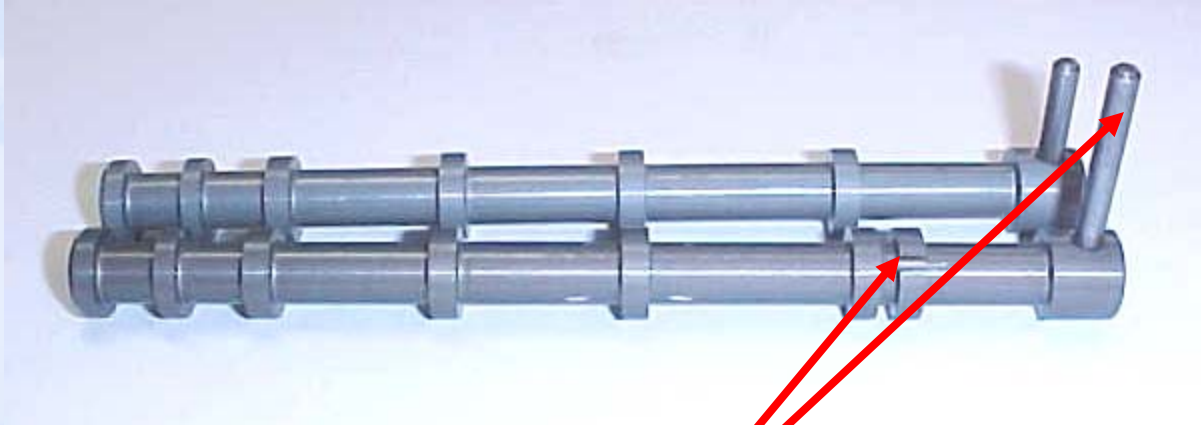

The 68RFE has an extra land and a notch on the manual lever. It also has a long pin.

# Pump Cover



The 68RFE and 45RFE pump cover look similar but the profile of the covers are different. This is to accommodate the differences in the 68RFE pump and 45RFE pump.

The pump covers will be stamped with either a 45RFE or 68RFE for identification.



The 68RFE contours up higher than the 45RFE.

# Pump Cover

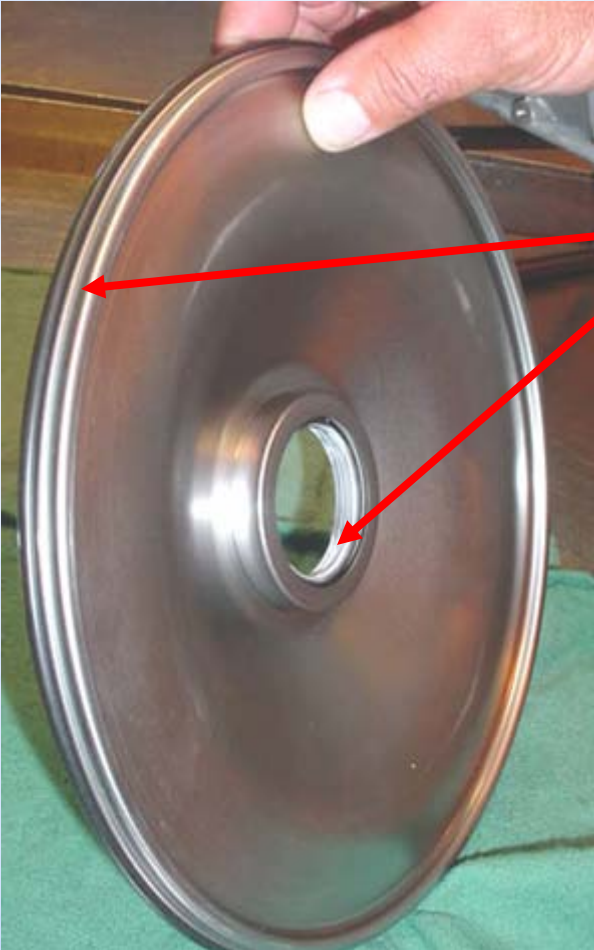

The ID of the seal has dry wax (white in color) on it instead of transmission fluid. To protect the seal, there is also a metal ledge on the inside of the pump cover. It also has a groove on the outer diameter to retain the o-ring.



# Adapter - 52119637AA

68RFE

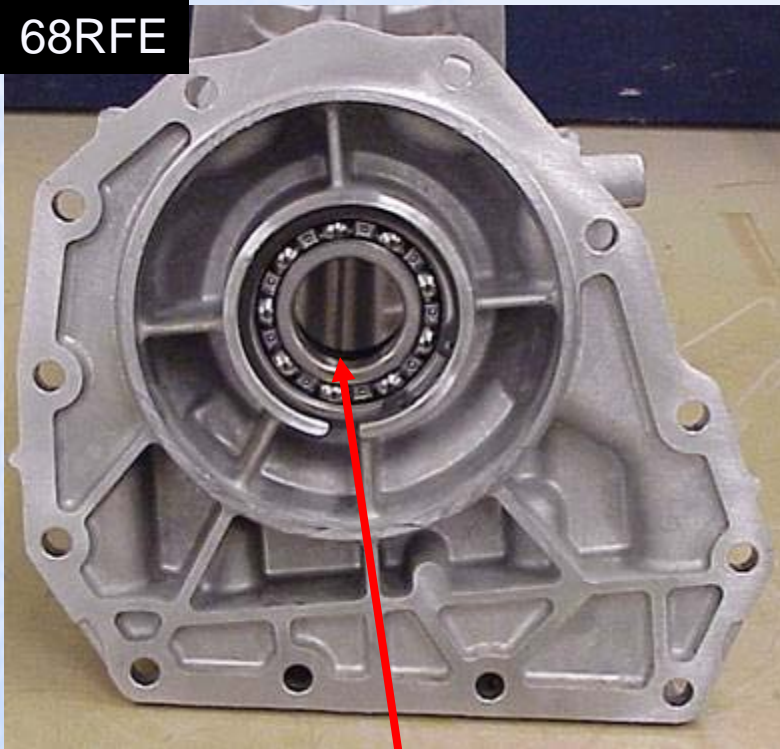

68RFE

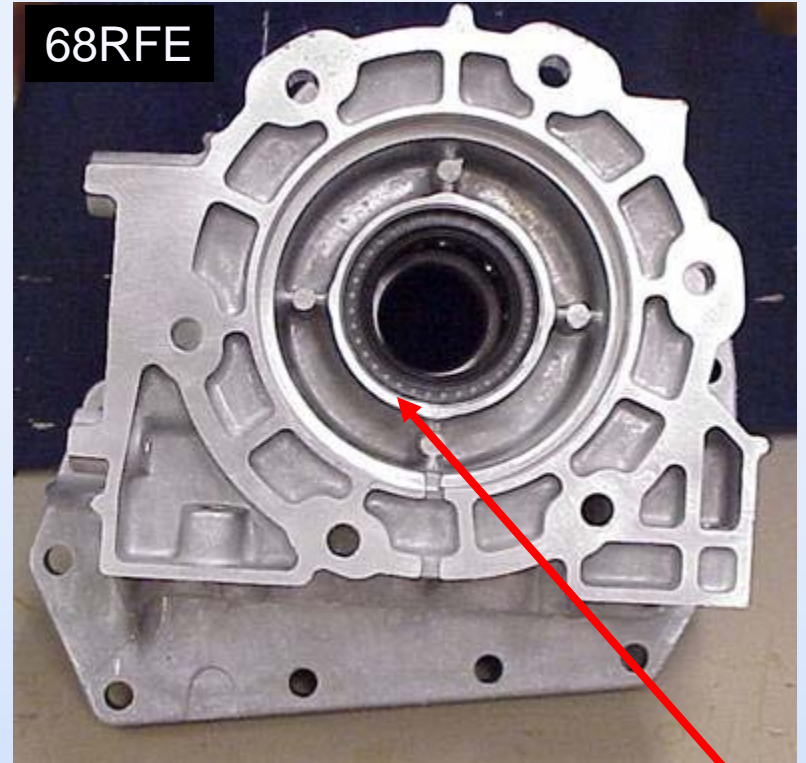

The adapter for the 68RFE looks exactly like the 52119433AB adapter for the 45RFE. The difference is the inner diameter on the 68RFE is larger than the 45RFE and the seal will already be installed by the supplier.

# Extension - 52119638AA

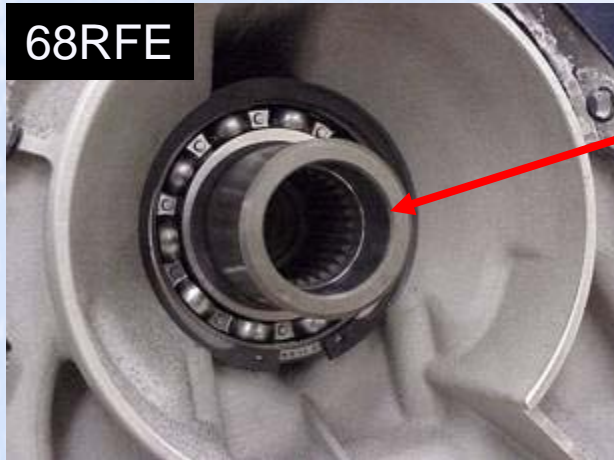

The 68RFE extension has a shaft that sticks out of the bearing. The 45RFE does not.

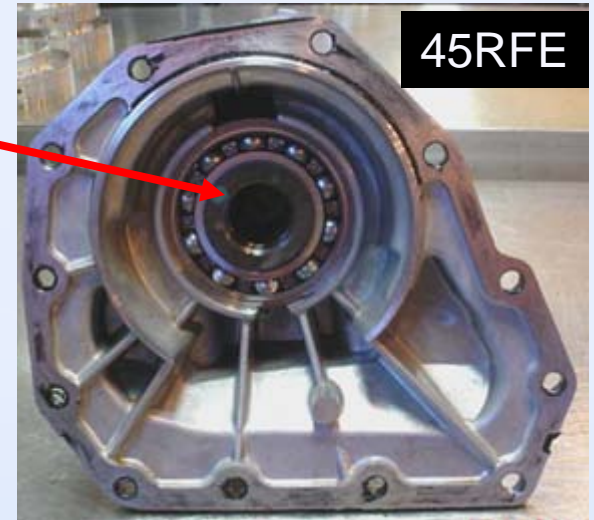

The casting for the 68RFE is visibly different than the 45RFE.





# Torque Converter - 52119671AD

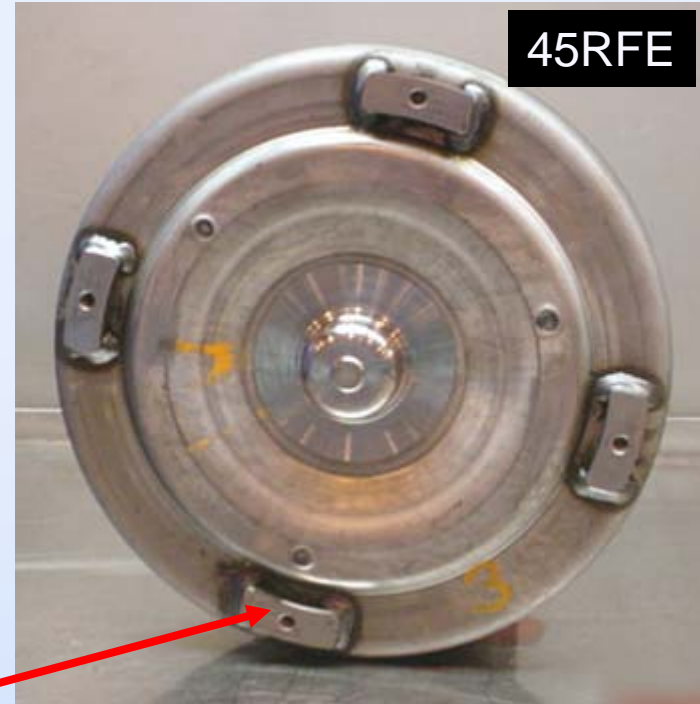
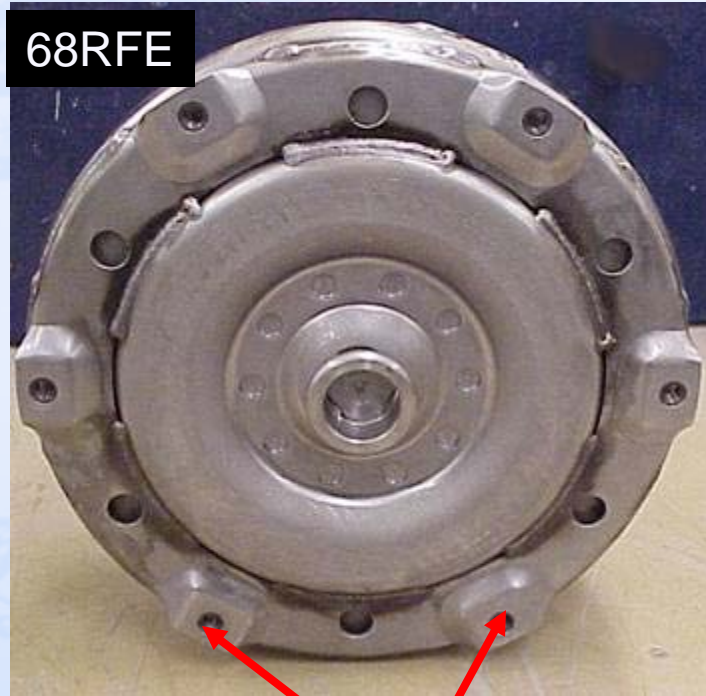

The front of the 68RFE torque converter has six drive holes and the 45RFE has four drive lugs. The 68RFE has a 12.2" torque converter and the 45RFE has a 10.7" torque converter.



# Torque Converter

68RFE



45RFE

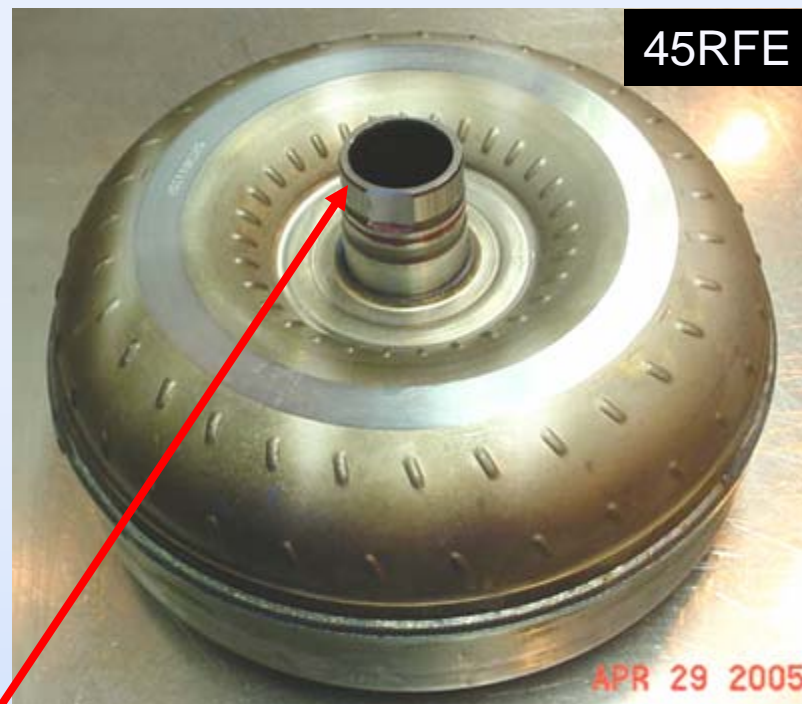

The hub side of the torque converters look very similar. The 68RFE has a larger outer diameter and the impeller hub has four D-flats and the 45RFE has two.

# Cooler Fittings - 55111025AB

68 RFE



**68RFE has an o-ring**



**45RFE does not have an o-ring and has sealant on the threads.**



**The 68RFE cap is larger in diameter and taller than the 45RFE. The hex head size on the 68RFE is larger than the 45RFE.**

# Today's Presentation Sponsored By:



# THANK YOU



# Lwiggins@ATRA.com

---

- \* Questions

- \* Survey

- \* Thanks For Attending, See you during our  
Next ATRA webinar

Thanks to our supplier for support