

# **REPAIR-MANUAL**

## **5 HP - 18**



**ZF GETRIEBE GMBH SAARBRÜCKEN**

**Impressum:**

Verantwortlich für den Inhalt  
Abteilung MKTD, ZF Getriebe GmbH,  
Saarbrücken  
Druck: HAGER PAPPRINT GmbH, St. Ingbert  
Gedruckt in der BRD

Published by ZF Getriebe GmbH,  
Saarbrücken, Department-MKTD  
Printed in Germany by  
HAGER PAPPRINT GmbH, St. Ingbert.

# CONTENTS

	<b>Page</b>
<b>Preliminary information</b>	<b>1</b>
<b>1. General remarks</b>	<b>2</b>
1.1 Drawing of transmission	2
1.2 Power flow schematic	3
1.3 Oil flow charts	4
1.4 Adjustment work	5/1
1.4.1 Release clearance at clutch F (snap ring)	5/1
1.4.2 Release clearance at brake G (snap ring)	5/2
1.4.3 Release clearance at brake D (snap ring)	5/3
1.4.4 Clearance at output side (washer)	5/4
1.4.5 Release clearance at clutch E (snap ring)	5/6
1.4.6 Release clearance at clutch A (snap ring)	5/7
1.4.7 Release clearance at brake C <sup>1</sup> (snap ring)	5/8
1.4.8 Transmission axiale clearance (washer)	5/9
1.4.9 Release clearance at brake C <sup>2</sup> (two washers)	5/11
1.5 Tightening torques	6
1.6 Troubleshooting (faults, causes and remedies)	7/1
1.7 Checking the transmission	8
1.8 Special tools	9
<b>2. Dismantling</b>	<b>10</b>
2.1 Dismantling according to assembly groups	10
2.2 Output side	16
2.3 Planetary gears, complete	18
2.3.1 Planetary gear set III	18
2.3.2 Clutch F	20
2.3.3 Brake DG with 1st gear freewheel	21
2.4 Input side	24
2.4.1 Clutch E	25
2.4.2 Clutch A	26
2.4.3 Clutch B and 3rd gear freewheel	27
2.4.4 Brake C <sup>2</sup>	30
2.5 Oil supply unit with brake C <sup>1</sup>	31
2.6 Housing with shift and parking pawl	32
<b>3. Assembling according to assembly groups</b>	<b>35</b>
3.1 Housing with shift and parking pawl	35
3.2 Planetary gear set, complete	39
3.2.1 Planetary gear set III	39
3.2.2 Clutch F	41
3.2.3 Brake DG with 1st gear freewheel	43
3.3 Output side	48
3.4 Planetary gear sets I and II	51
3.5 Input side	56
3.5.1 Clutch E	56
3.5.2 Clutch A	58
3.5.3 Clutch B and 3rd gear freewheel	61
3.5.4 Brake C <sup>2</sup>	66
3.6 Oil supply unit with brake C <sup>1</sup>	68
3.7 Selector unit, oil sump and converter	75

## PRELIMINARY INFORMATION

This manual contains precise details of how to repair the complete transmission.

All dismantling and assembly work is described in the correct order.

The photographs have been selected to cover various types of transmission and may therefore differ from the vehicle on which you are working.

The component list precisely defines which version of the transmission you are working on, and this is also reflected in the parts list.

If any major modifications have to be taken into account when repairs are carried out, you will be notified by Technical Bulletin.

Depending on the nature of the fault, it may be possible to limit the repair to the actual components and areas of the transmission that have failed.

In this connection, please note:

- Always renew the pistons if there is a fault on clutch F or brake G. Never re-use seals, for example O-rings and shaft sealing rings.
- If the transmission has been run for a considerable distance (> 50.000 km), renew all lined and steel discs.
- If clutch damage has occurred the converter, oil cooler lines and the oil cooler itself must be thoroughly flushed out with a suitable cleaning agent.

The following conditions must be satisfied:

- The necessary special tools must be available  
The complete set is listed in Section 1.8 of this manual.
- A suitable transmission test rig should be available.  
Refer to the Technical Bulletins for the relevant test values.

### NOTE:

In this manual the control unit is treated as a single element; it should always be exchanged as a complete unit and not dismantled except by suitably trained personnel possessing full knowledge of its design.

### Warning:

The transmission should only be delivered with the oil content stated in the relevant component list (on microfiche).

## 1. General information

### 1.1 Drawing of transmission



1.2 Power flow

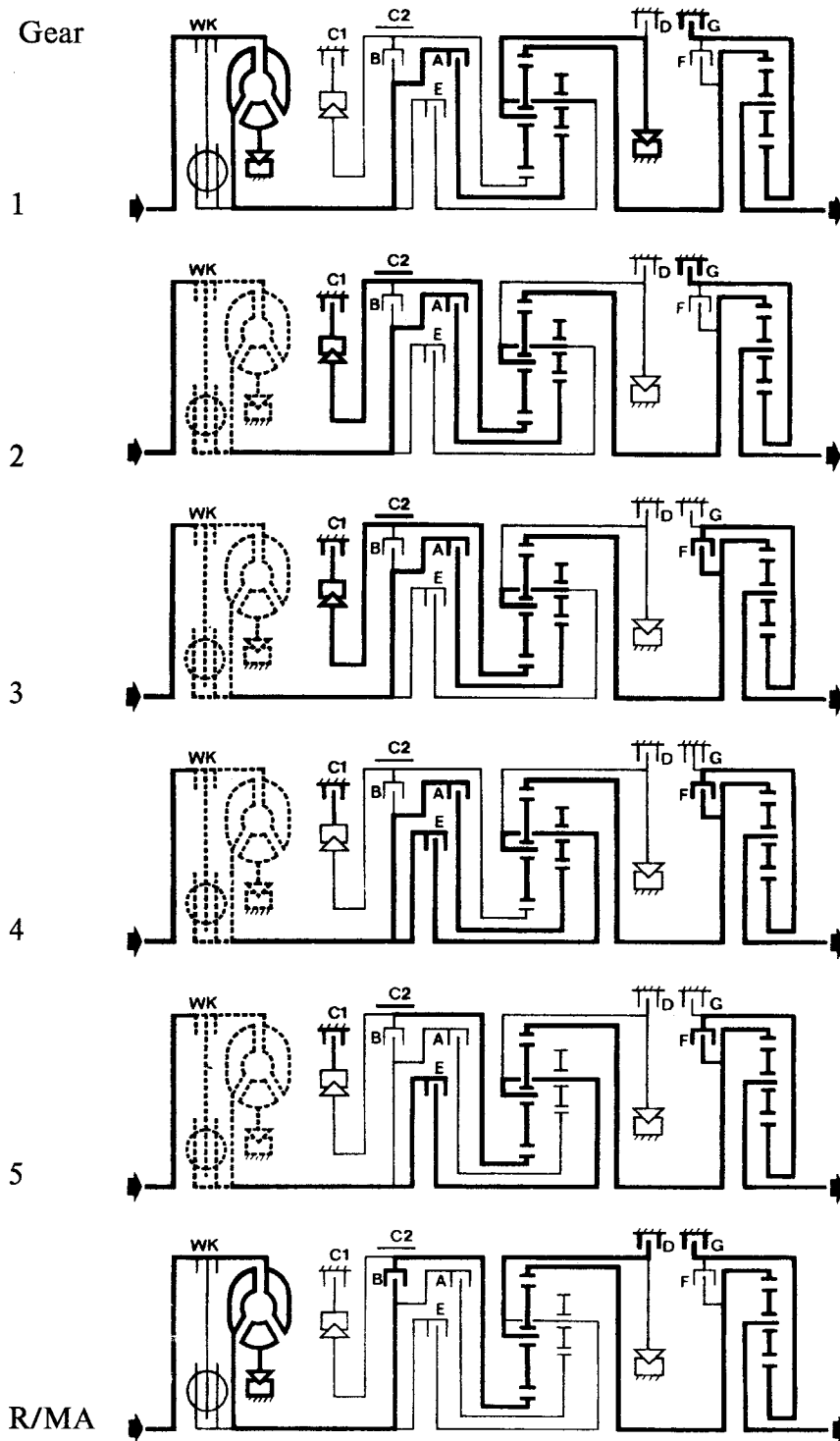

For a full description, refer to separate documentation.

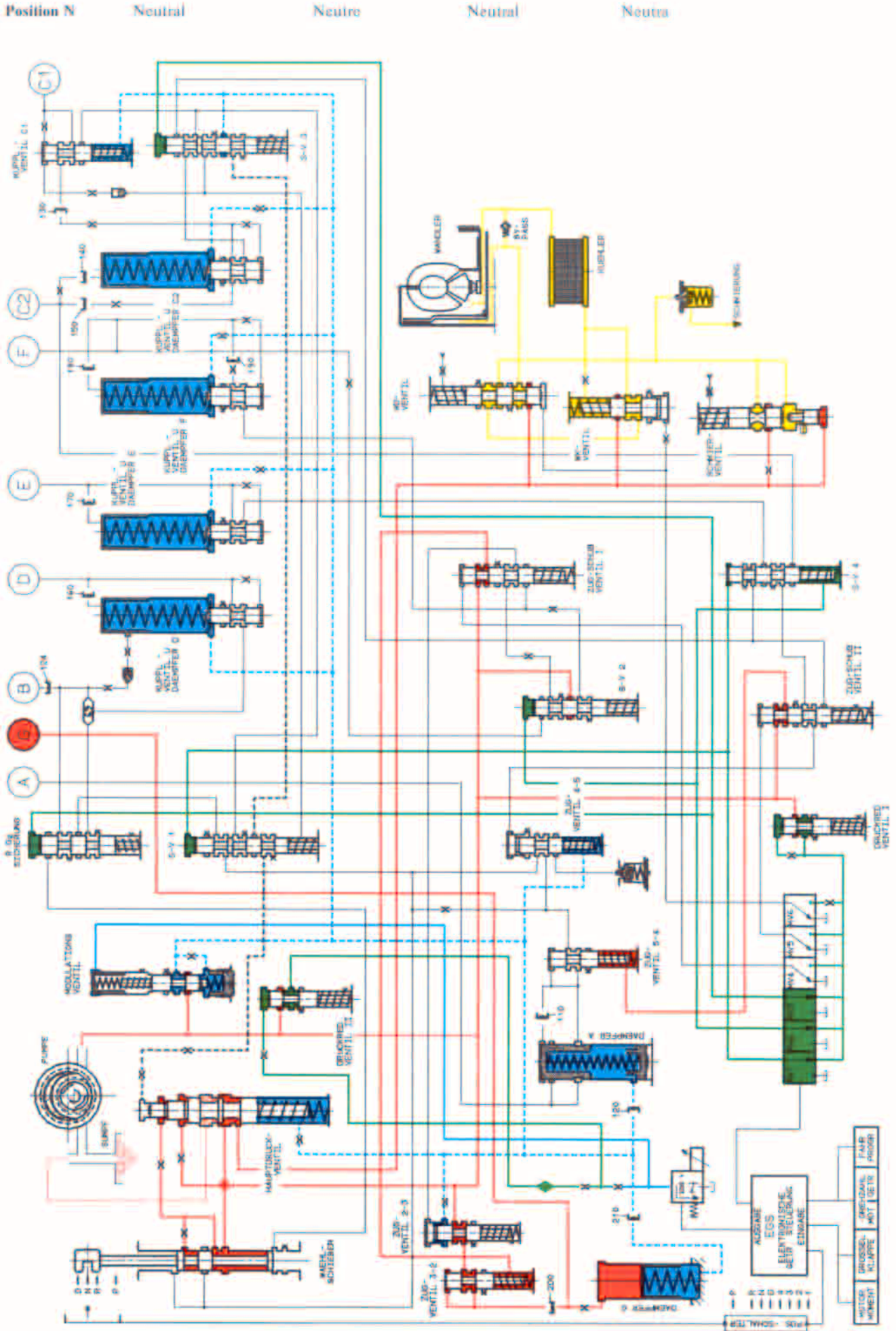

**1.4 Adjustment work**

91 084

**1.4.1 Release clearance at clutch F (snap ring)**

Insert snap ring 77.010/180.  
 (Selected thickness = 1.9 mm).  
 Place dial gauge and bar in position.  
 Extend dial gauge pointer until it touches the end disc, and set dial gauge to "0".

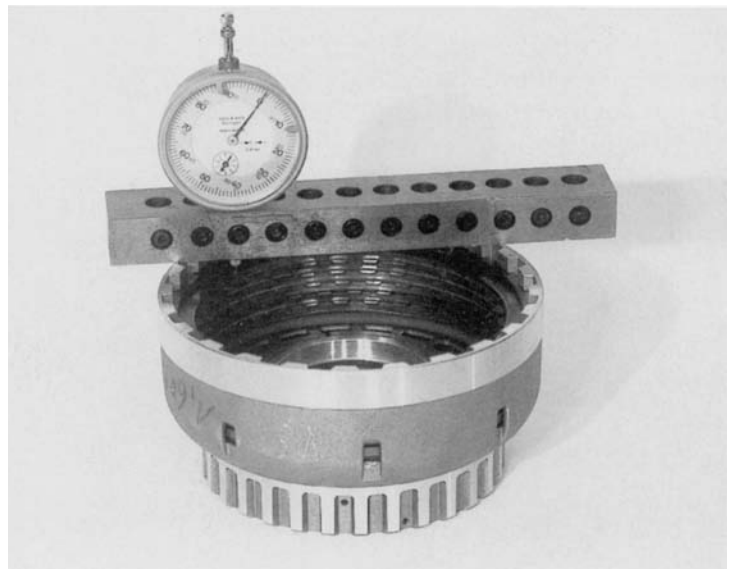

91 085

Raise the complete disc set and read off play at the dial gauge.  
 It should be:  
 - with 4 lined discs = 1,30 to 1,60 mm  
 - with 5 lined discs = 1,65 to 1,95 mm

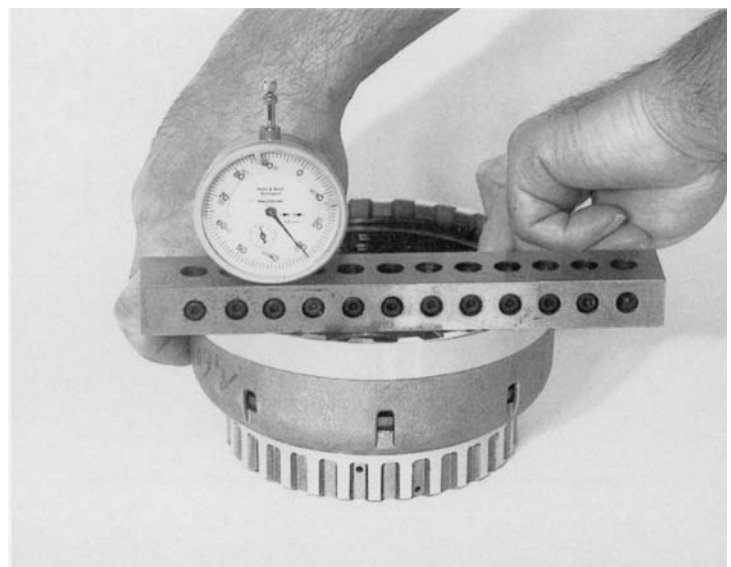

91 086

If a different reading is obtained, select a thicker or thinner snap ring.

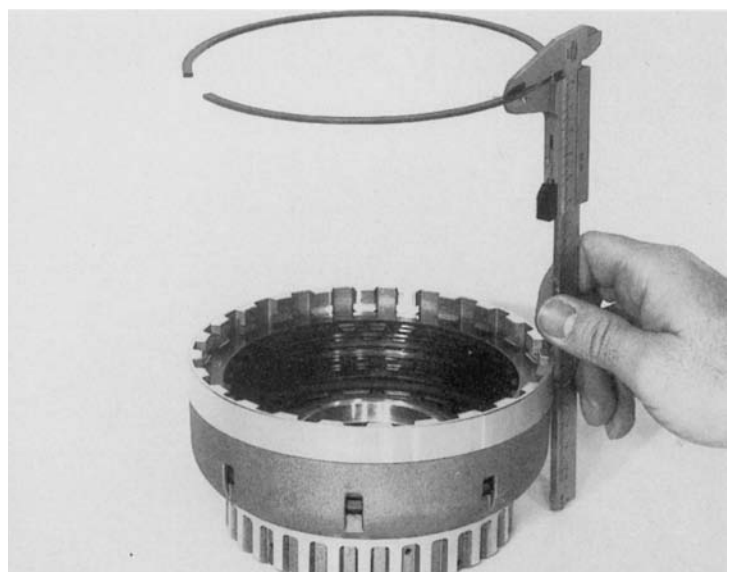



**1.4.2 Release clearance at brake G  
(snap ring)**

91 088

Insert complete disc set G.  
Starting with spring disc 73.040,  
insert steel discs 73.050 and lined  
discs 73.060 alternately.  
Place final disc 73.070 in position  
and insert snap ring 73.080.  
(Selected thickness = 2.1 mm.)

Place dial gauge with bar in position.  
Extend the dial gauge pointer as far  
as the final disc and set the dial  
gauge to "0".

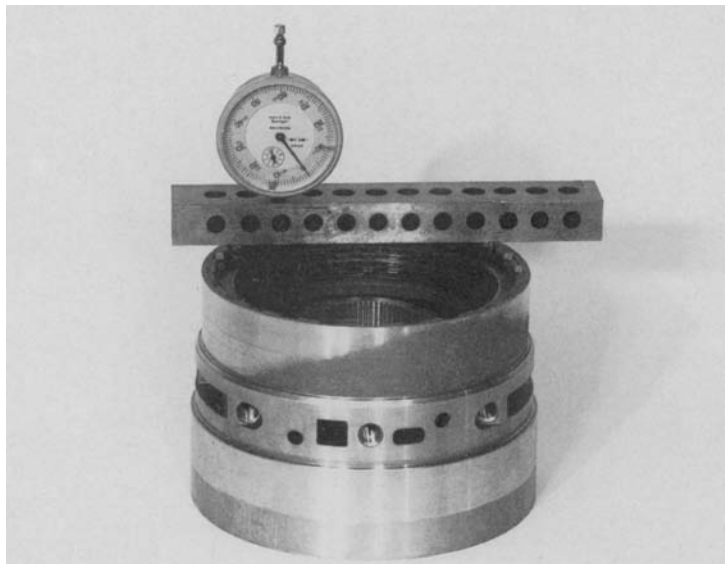

Raise the complete disc set and read  
off play at the dial gauge.

It should be:

- with 3 pairs of discs = 0.95 to 1.25 mm
- with 4 pairs of discs = 1.30 to 1.60 mm

91 089

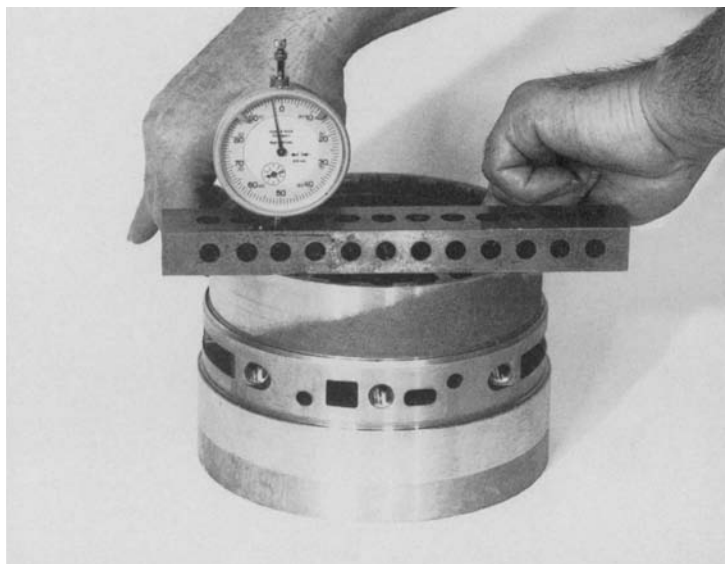

If a different reading is obtained,  
select a thicker or thinner snap ring.

91 090

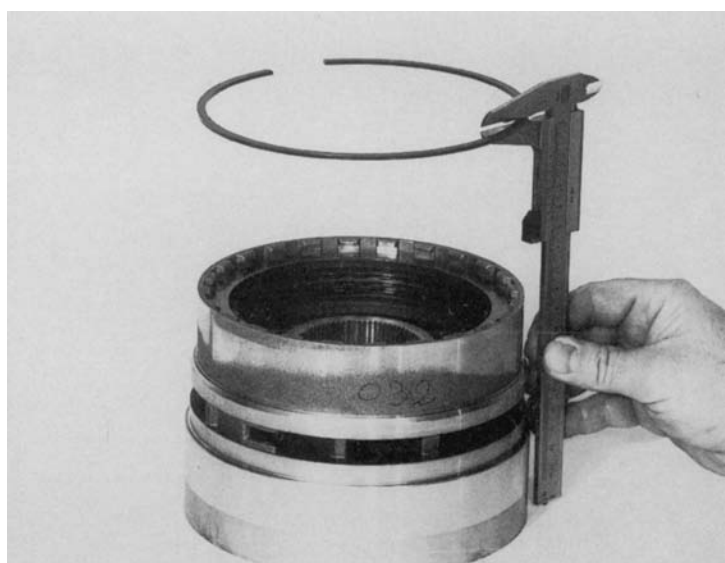

**1.4.3 Release clearance at brake D (snap ring)**

91 091

Insert complete set.  
 Starting with spring disc 73.010/160,  
 insert steel discs 73.010/170 and lined  
 discs 73.010/180 alternately.  
 Place final disc 73.010/190 in position  
 and insert snap ring 73.010/200.  
 (Selected thickness = 3.0 mm)

Place dial gauge with bar in position.  
 Extend the dial gauge pointer as far as  
 the final disc and set the dial gauge  
 to "0".

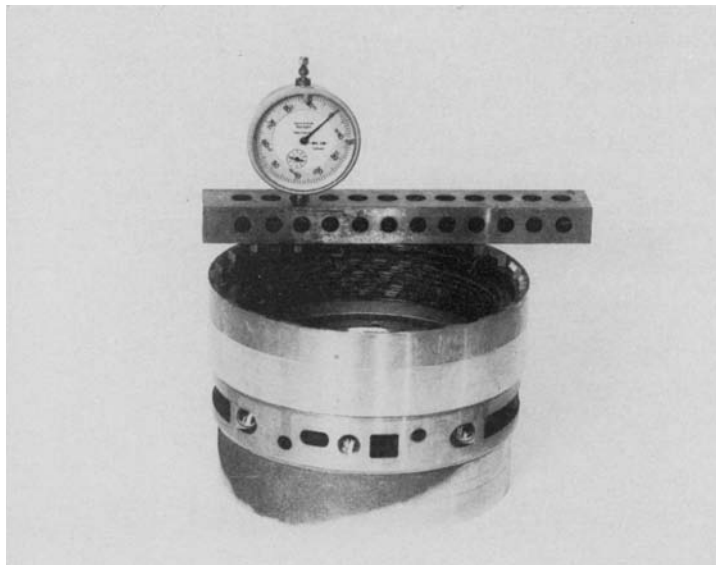

91 092

Raise the complete disc set and  
 read off play at the dial gauge.

It should be:

- with 5 pairs of discs = 1.75 to 2.26 mm
- with 6 pairs of discs = 2.09 to 2.74 mm

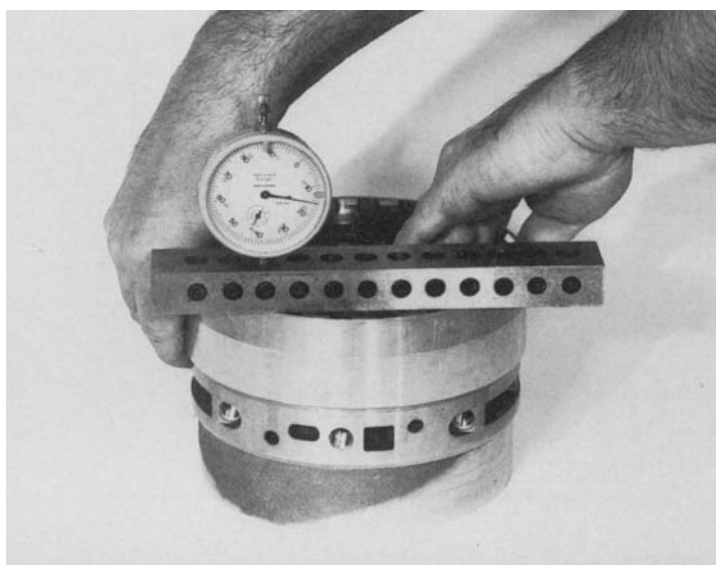

91 093

If a different reading is obtained,  
 select a thicker or thinner snap ring.

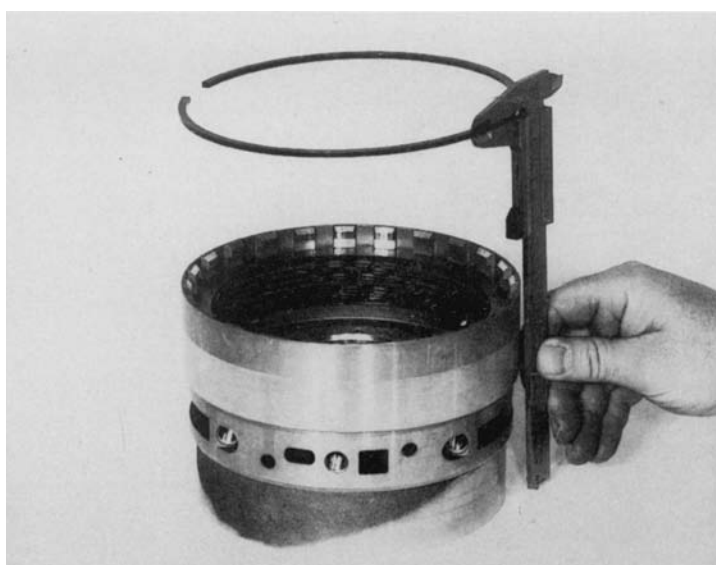

**1.4.4 Clearance at output side (washer)**

91 111

Support the dial gauge bar at approx. 140 mm intervals with approx. 20 mm thick gauge blocks. Set the dial gauge to "0" on a gauge plate.

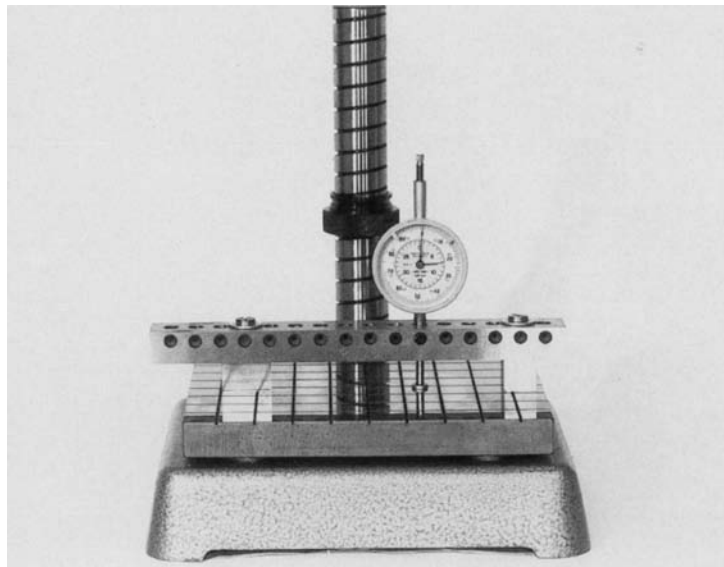

Place the output side on a suitable underlay or clamp into a vise.

91 112

**Warning!**

Do not place on the output flange.

To avoid incorrect readings, move the output flange towards the output side so that play is eliminated.

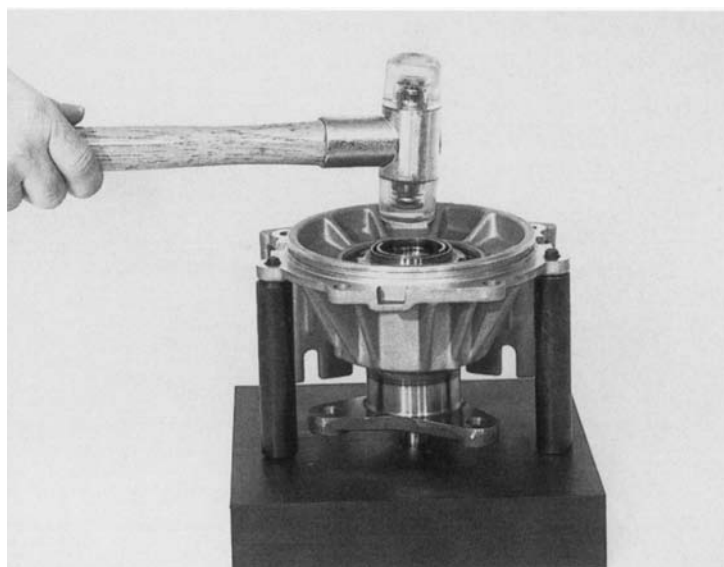

Determine **distance A:**

Measure between the machined face on the extension and the hub of the output flange.

91 113

**Example:** distance A = 2.50 mm

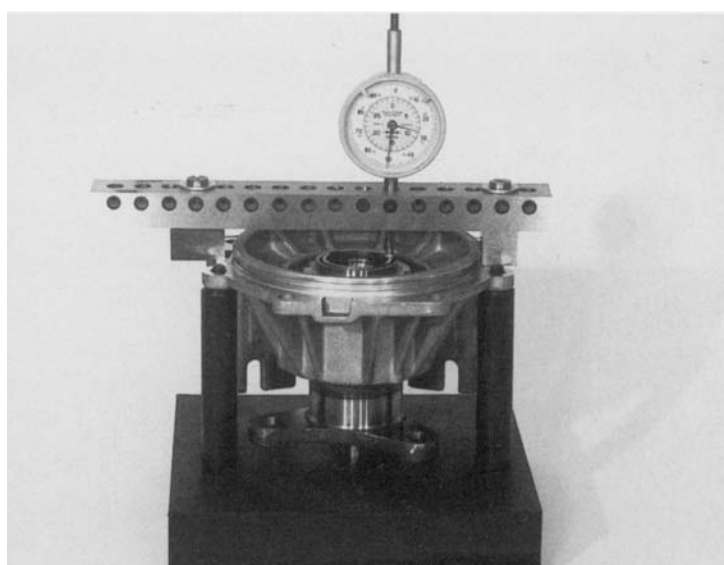

**Determine distance B:**

Using a depth gauge, measure between machined faces on transmission housing and parking pawl gear.

**Example:** distance B = 3.80 mm

91 114



Determine washer thickness "S" by the following formula:

**S = distance B - distance A - play**

acc. to gauge

clearance acc. parts list

Play acc. to gauge = 0.15 to 0.35 mm

introduction date: 01.91

**Example:**

**S = 3.80 mm - 2.50 mm - 0.15 to 0.35 mm**

**S = 0.95 mm to 1.15 mm**

91 115



**1.4.5 Release clearance at clutch E  
(snap ring)**

91 131

Insert snap ring 71.130.  
(Selected thickness = 1.5 mm).  
Place dial gauge with bar in position.  
Extend the dial gauge pointer as far as the final disc and set the dial gauge to "0".

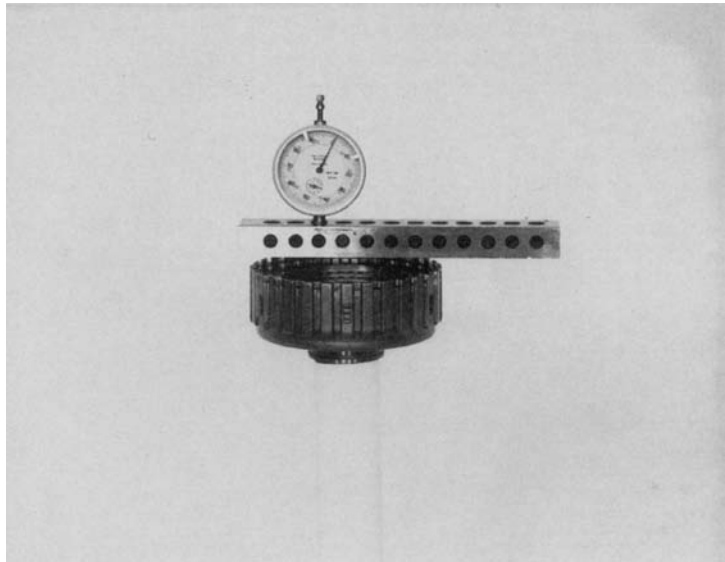

Raise the complete disc set and read off play at the dial gauge.  
It should be:  
- with 4 pairs of discs = 1.12 to 2.11 mm  
- with 5 pairs of discs = 1.50 to 2.50 mm

91 132

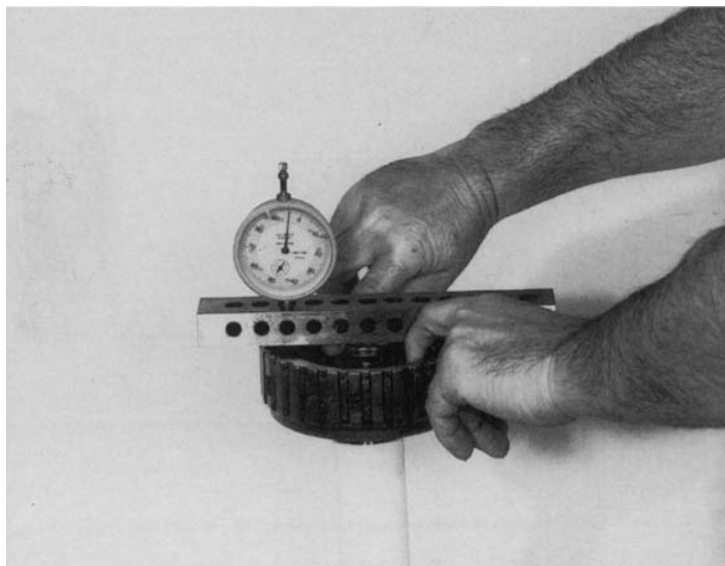

If a different reading is obtained,  
select a thicker or thinner snap ring.

91 133

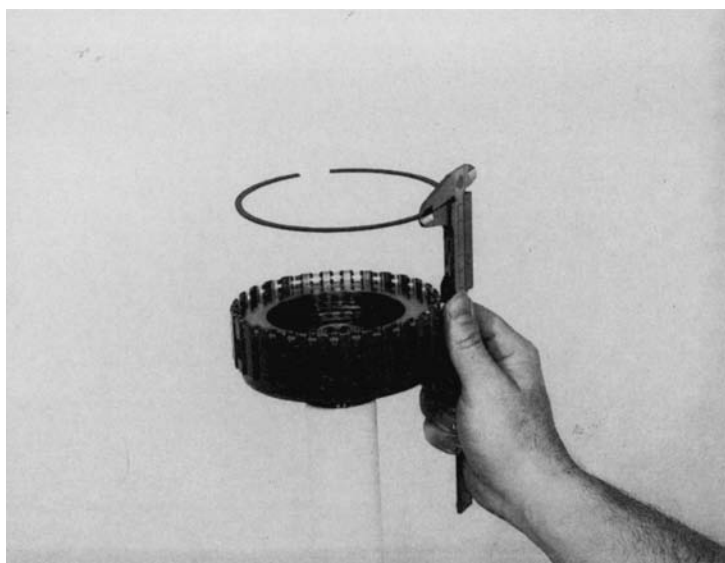

**1.4.6 Release clearance at clutch A  
(snap ring)**

85 271

Insert snap ring 70.010/230.  
(Selected thickness = 1.4 mm.)  
Place dial gauge with bar in position.  
Extend the dial gauge pointer as far  
as the final disc and set the dial  
gauge to "0".

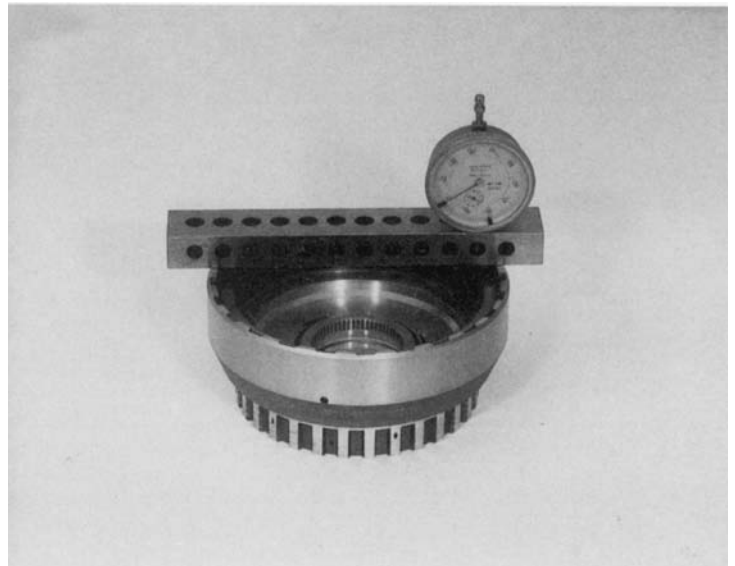

85 272

Raise the complete disc set and  
read off play at the dial gauge.  
It should be:  
- with 4 pairs of discs = 1.30 to 1.60 mm  
- with 5 pairs of discs = 1.65 to 1.95 mm

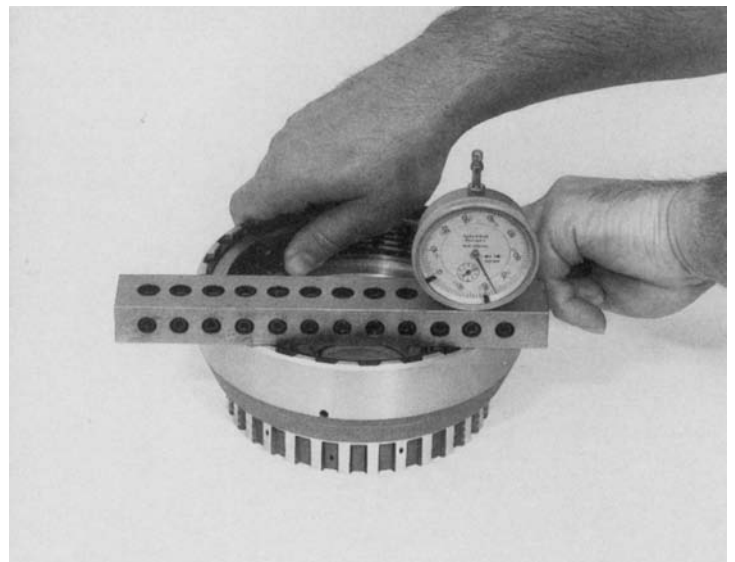

85 273

If a different reading is obtained,  
select a thicker or thinner snap ring.

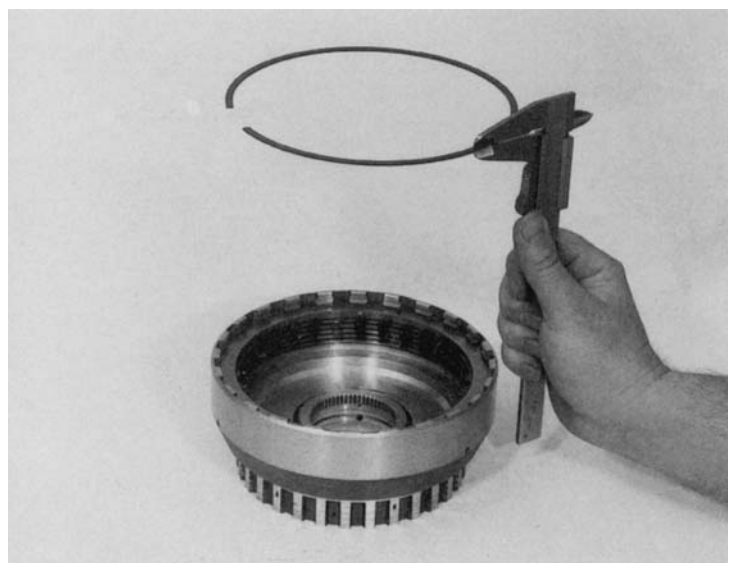

**1.4.7 Release clearance at brake C<sup>1</sup> snap ring)**

91 155

Insert snap ring 10.130.  
 (Selected thickness = 1,5 mm).  
 Place dial gauge with bar in position.  
 Extend the dial gauge pointer as far as the final disc and set the dial gauge to "0".

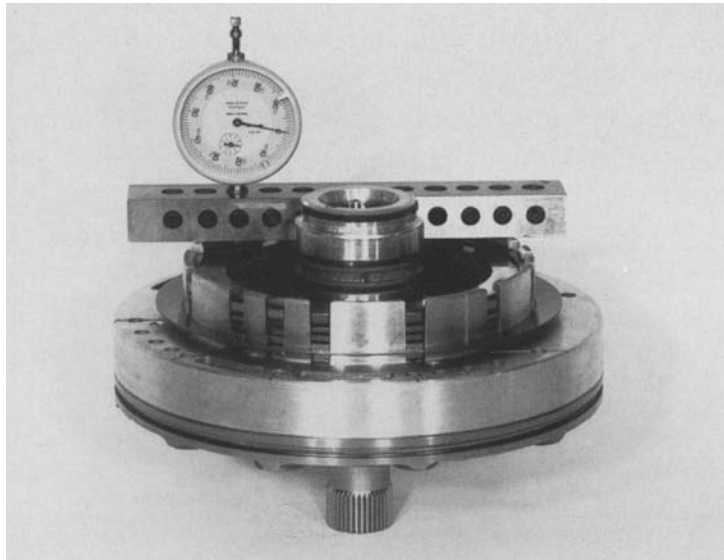

Raise the complete disc set and read off play at the dial gauge.  
 It should be:  
 - with 3 pairs of discs = 0.95 to 1.25mm  
 - with 4 pairs of discs = 1.30 to 1.60mm

91 156

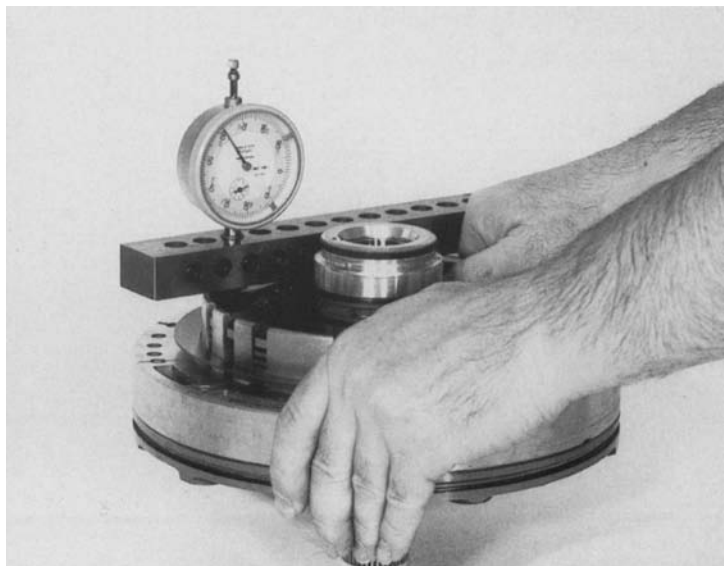

If a different reading is obtained, select a thicker or thinner snap ring.

91 157

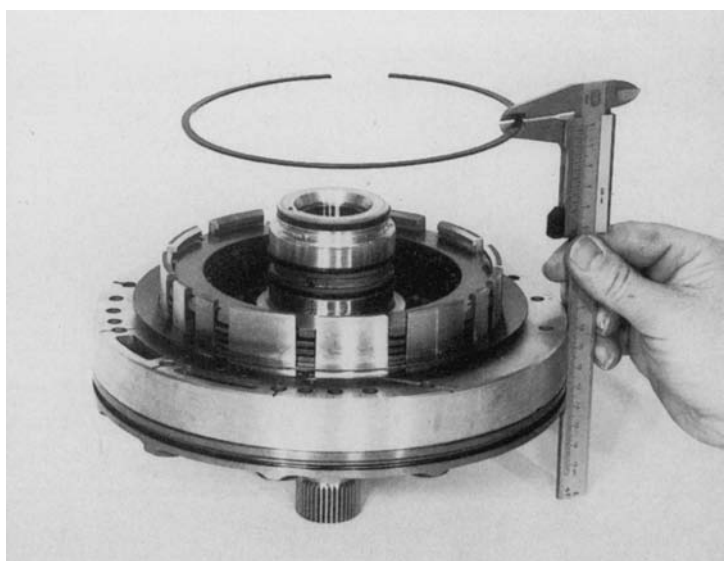

### 1.4.8 Transmission axiale clearance (washer)

91 158

#### Requirements:

Angle disc 10.190, needle roller thrust bearing 10.200 and shim washer 10.210 (selected thickness = 2.0 mm) are attached to the intermediate plate with grease.

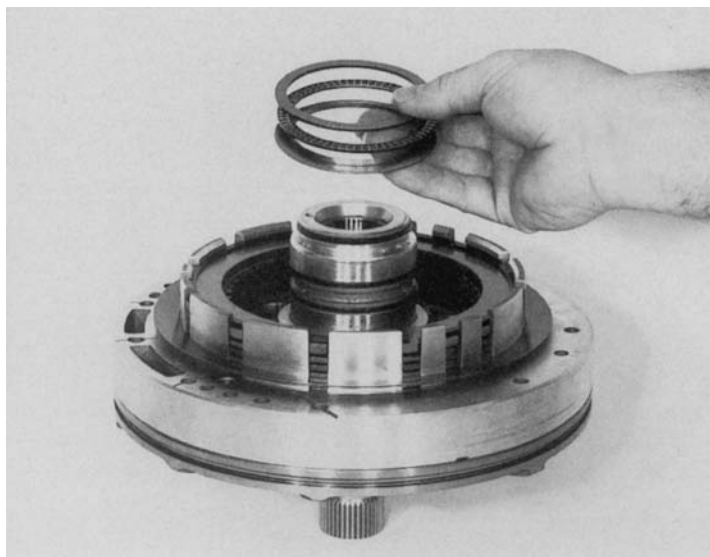

91 159

Clamp assembly fixture 5 X 46 000 563 on to the stator shaft and align the rectangular-section rings on centering fixture 5 X 46 000 312.

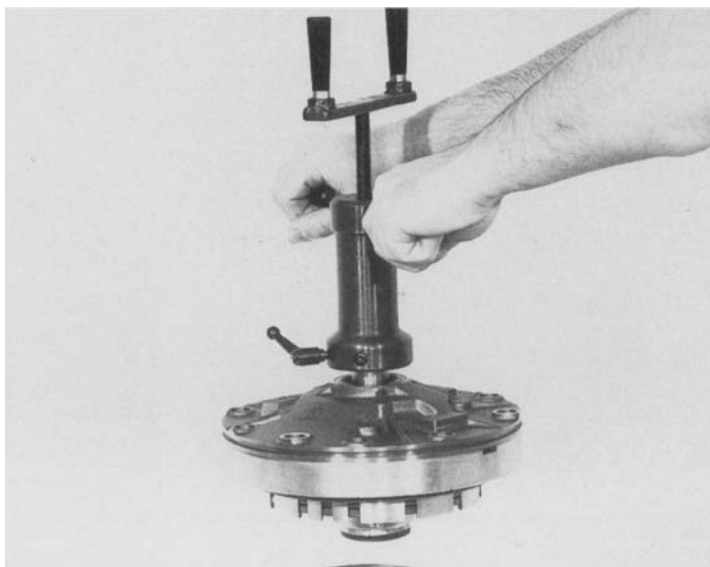

91 160

Insert the oil supply unit, at the same time turning in both directions until the diaphragm spring of brake C is touching the housing. (Test by applying pressure: spring contact should be felt.)

See also adjacent picture.

#### Warning!

This is a difficult assembly operation and must be carried out with great care.

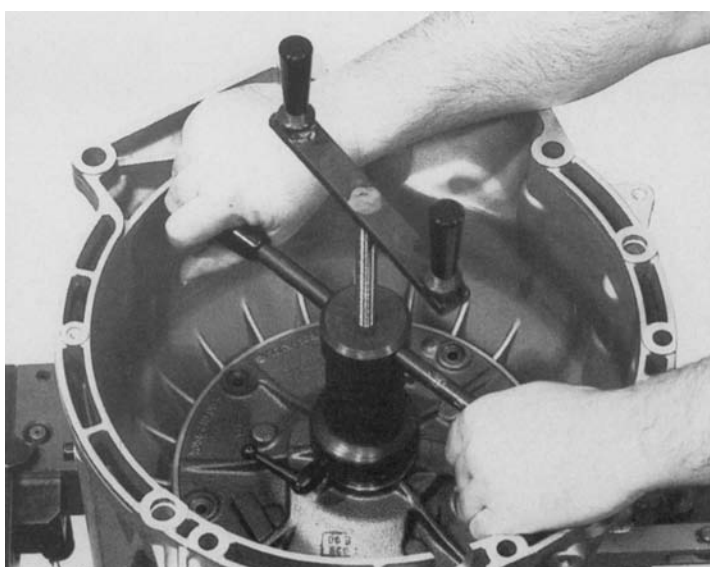



91 161

Attach the oil supply unit with two machine screws on opposite sides.  
(Wrench size = TX-27).  
(Tightening torque = 10 Nm).

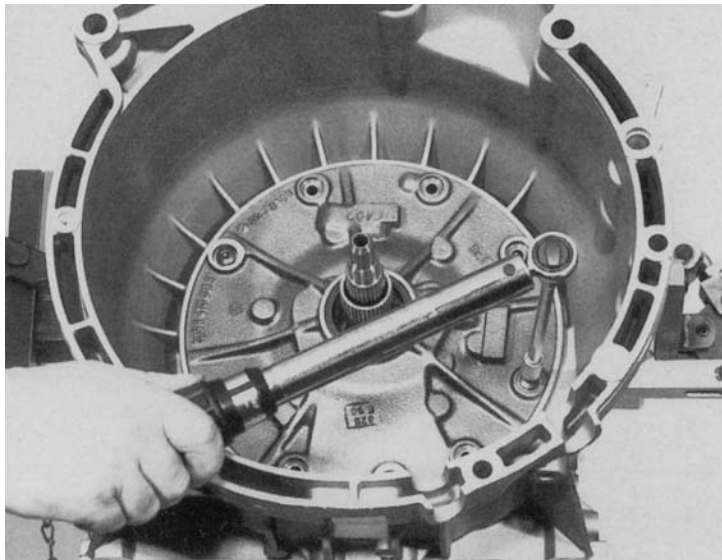

91 162

Clamp the sleeve of measuring device 5 P 01 001 415 by its 3 retaining bolts to the stator shaft, so that no play is present.  
Push measuring device 5 P 01 001 415 over the input shaft splines and secure with the locking screw so that it can not tilt.

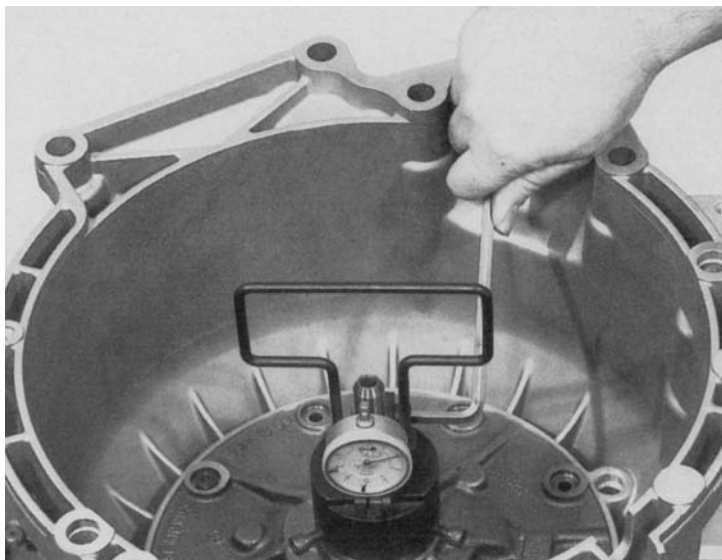

91 163

Pull the handle to determine end play (take the measurement more than once).  
Desired end play value = 0.10 – 0.30 mm.  
If this value is not reached, insert a thicker or thinner washer 10.210, than check end play again.  
Unscrew and lift out the oil supply unit.

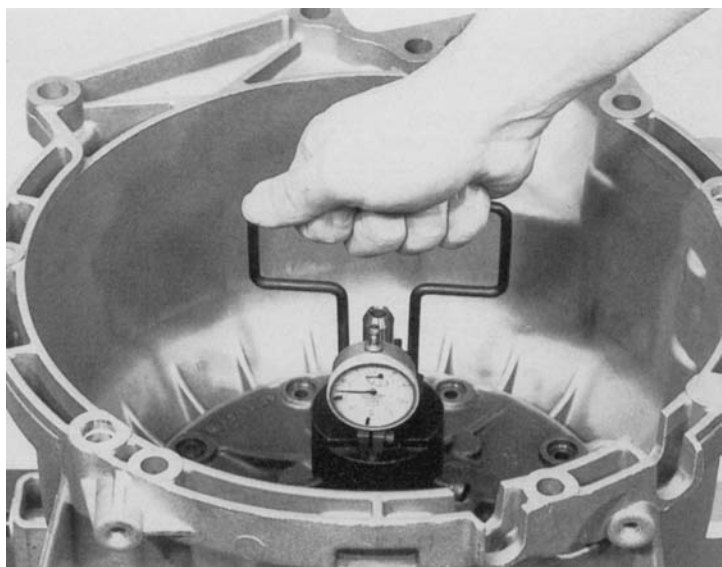

**1.4.9 Release clearance at brake C<sup>2</sup>  
(two washers)**

**Requirements:**

1. The fully assembled piston 75.030 and washer 75.034 and shim washer 75.040, must be installed.
2. Cover 75.050 must be inserted and secured with snap ring 75.060.

**Example:**

Shim washer 75.040 = 3.25 mm thick;  
washer 75.034 = 3.25 mm thick

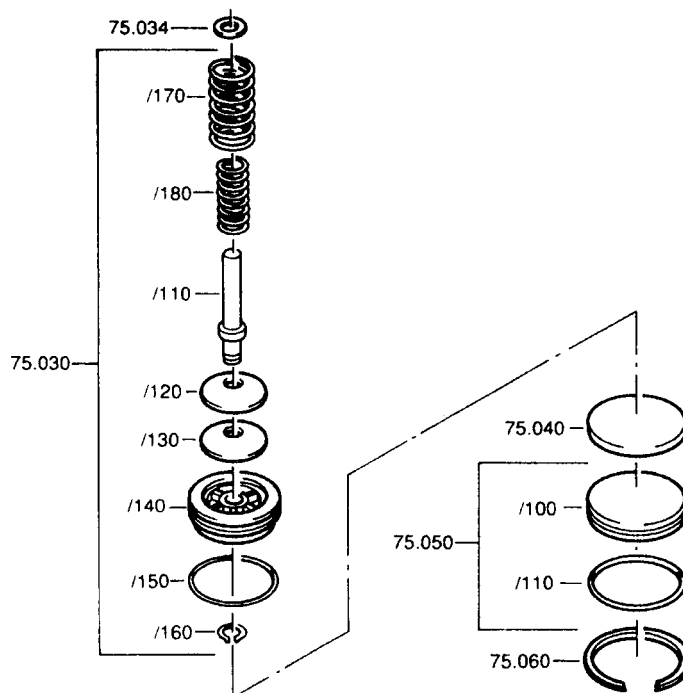

91 173

Since the release clearance **must** be determined under load, it is essential to use measuring device 5 P 01 002 028. Set the dial gauge to "O" in the off-load position.

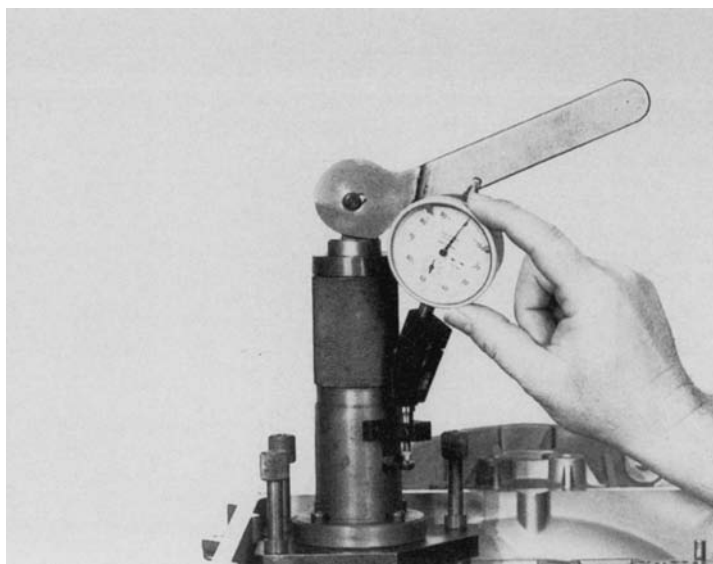

91 174

Tension the measuring device by moving the eccentric lever round. The release clearance can then be determined and read off at the dial gauge.

(Example: measure release clearance = 1.80 mm)

**Desired release clearance – 1.35 to 1.70 mm**

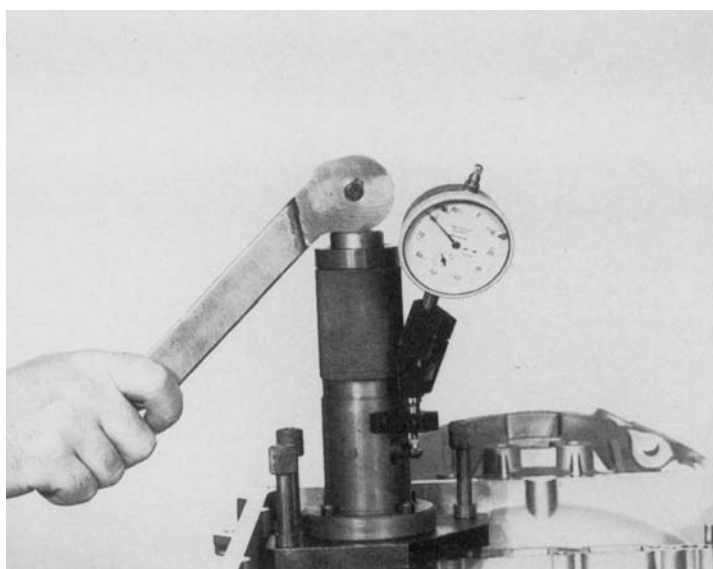

If the release clearance is too large, insert a thicker shim washer 75.040 and a thinner washer 75.034. If it is too small, the opposite procedure applies.

**Important:**

Select washers as shown in the adjacent table.

**Paired washers**

Shim washer Pos. 75.040 (mm)	Washer Pos. 75.034 (mm)
1,50	5,00
1,75	4,75
2,00	4,50
2,25	4,25
2,50	4,00
2,75	3,75
3,00	3,50
3,25	3,25
3,50	3,00
3,75	2,75
4,00	2,50
4,25	2,25

91 175

**Example:**

Install a 3,50 mm thick shim washer 75.040 with a 3,00 mm thick washer 75.034.

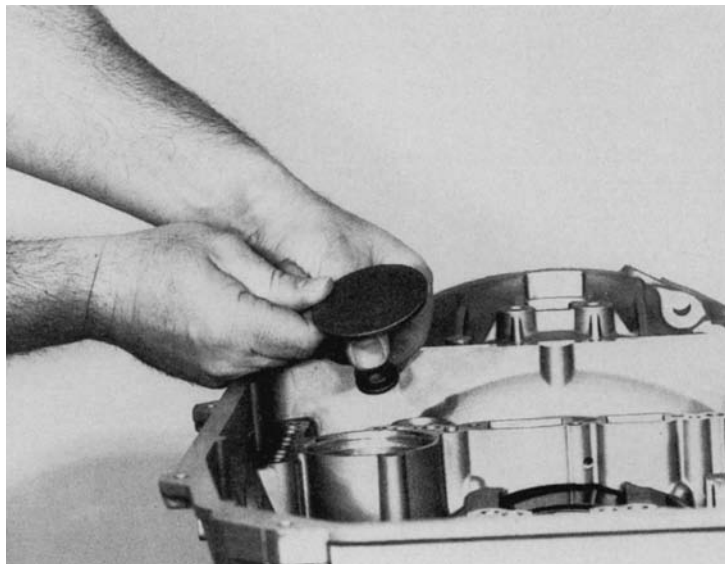

### 1.5 Tightening torques

Item	Wrench size	See page	Tightening torque
– Screw plug (transmission housing)	5 mm Allen screw	35/73	15 Nm
– Machine screw (detent spring)	TORX-TX 27	36	10 Nm
– Screw plug (pawl pin)	6 mm Allen screw	38	32 Nm
– Machine screw (guide plate)	TORX-TX 27	38	10 Nm
– Machine screw (complete planetary gear set)	TORX-TX 50	49	See directive
– Slotted nut (output side)	Socket wrench 5 X 46 000 541	49	120 Nm
– Machine screw (output side)	13 mm across flats	49	23 Nm
– Csk. screw (intermediate plate, pump)	TORX-TX 30	68	10 Nm
– Machine screw (oil supply unit)	TORX-TX 27	5/10 and 71	10 Nm
– Hex nut (wiring harness)	32 mm across flats	74	20 Nm
– Machine screw (selector unit)	TORX-TX 27	75	8 Nm
– Machine screw (filter)	TORX-TX 27	76	8 Nm
– Screw plug (oil sump) M 10 x 1	5 mm Allen screw	76	15 Nm
– Screw plug (oil sump) M 30 x 1,5	17 mm Allen screws	76	100 Nm
– Collar nut (oil sump)	30 mm across flats	76	Pre-assembly: 20 Nm Final assembly: 100 Nm
– Hex bolt (oil sump)	10 mm across flats	77	6 Nm

# **Troubleshooting 5 HP 18 EH automatic transmission and electronic-hydraulic selector unit**

## **Introduction**

The troubleshooting table which follows is intended as an aid to diagnosing malfunctions in the ZF 5 HP 18 EH automatic transmission and taking the correct remedial action.

The malfunctions have been stated in the same way as the customer would generally describe them. However, the same fault can often be described in different ways; the person accepting the customer's instructions should bear this in mind when deciding which fault may have occurred.

If leaks are complained of, it is best to determine the precise leakage point before attempting any sealing work. This can be done with a suitable crack testing agent such as

Met-L-Chek

This product is available as a spray from trade outlets. After it has been applied and a short test run undertaken, the leakage point can be accurately located.

### **Warning:**

For all troubleshooting work on the automatic transmission, it is assumed that both the mechanical and electrical peripherals (transmitted signals, cables and lines) are in good working order.

In terms of the vehicle's control circuits, the automatic transmission is a passive element and will also carry out incorrect commands (information) from the periphery. It is wrong to assume that such commands represent faults in the automatic transmission. Notes on troubleshooting in peripheral equipment are included.

## Troubleshooting – 5 HP 18 EH automatic transmission

Malfunction	Possible cause	Remedial action
<p><b>1. Position P</b></p> <p>1.1 Park position does not engage reliably</p>	<ul style="list-style-type: none"> <li>– shift cable between selector lever and transmission is incorrectly adjusted</li> <li>– too much friction in parking interlock mechanism</li> </ul>	<ul style="list-style-type: none"> <li>– adjust correctly</li> <li>– renew parking interlock components (connecting rod, pawl)</li> </ul>
<p>1.2 Park position does not stay engaged (slips out)</p>	<ul style="list-style-type: none"> <li>– shift cable between selector lever and transmission is incorrectly adjusted,</li> </ul>	<ul style="list-style-type: none"> <li>– adjust correctly</li> </ul>
<p>1.3 Engine cannot be started</p>	<ul style="list-style-type: none"> <li>– position switch incorrectly adjusted</li> <li>– position switch defective</li> </ul>	<ul style="list-style-type: none"> <li>– adjust correctly</li> <li>– renew position switch</li> </ul>
<p>1.4 Engine starts although lever is in park position</p>	<ul style="list-style-type: none"> <li>– incorrect position switch</li> <li>– selector lever not correctly adjusted</li> <li>– position switch defective</li> </ul>	<ul style="list-style-type: none"> <li>– fit correct position switch</li> <li>– adjust correctly</li> <li>– renew position switch</li> </ul>
<p><b>2. Position R</b></p> <p>2.1 Reverse gear not available</p>	<ul style="list-style-type: none"> <li>– shift cable between selector lever and transmission is incorrectly adjusted</li> <li>– clutch B damaged beyond repair</li> <li>– Brake D damaged beyond repair (in this case, no braking effect in position 2, 1st gear)</li> <li>– brake G damaged beyond repair</li> <li>– see troubleshooting on hydraulic selector unit, item 1.1</li> </ul>	<ul style="list-style-type: none"> <li>– adjust correctly</li> <li>– fit an exchange transmission</li> <li>– fit an exchange transmission</li> <li>– fit an exchange transmission</li> <li>– ←</li> </ul>
<p>2.2 Violent jerk when shifting from P – R or N – R</p>	<ul style="list-style-type: none"> <li>– engine idle speed &gt; 1500 min</li> <li>– see troubleshooting on hydraulic selector unit, item 1.2</li> </ul>	<ul style="list-style-type: none"> <li>– adjust to correct idle speed</li> <li>– ←</li> </ul>

## Troubleshooting – 5 HP 18 EH automatic transmission

Malfunction	Possible cause	Remedial action
2.3 Reversing light does not come on (vehicle's electrics in working order)	<ul style="list-style-type: none"> <li>– position lever incorrectly adjusted</li> <li>– position switch defective</li> </ul>	<ul style="list-style-type: none"> <li>– adjust correctl</li> <li>– renew position switch</li> </ul>
<p><b>3. Position N</b></p> <p>3.1 Engine cannot be started</p>	<ul style="list-style-type: none"> <li>– position lever incorrectly adjusted</li> <li>– position switch defective</li> </ul>	<ul style="list-style-type: none"> <li>– adjust correctly</li> <li>– renew position switch</li> </ul>
3.2 Vehicle moves (creeps) forward	<ul style="list-style-type: none"> <li>– clutch A defective (discs fused together)</li> <li>– shift cable between selector lever and transmission is incorrectly adjusted</li> </ul>	<ul style="list-style-type: none"> <li>– fit an exchange transmission</li> <li>– adjust correctly</li> </ul>
<p><b>4. Position D</b></p> <p>4.1 Engine stalls when shifting from N to D</p>	<ul style="list-style-type: none"> <li>– converter lockup clutch engaged all the time</li> </ul>	<ul style="list-style-type: none"> <li>– see trouble-shooting on hydraulic selector unit, item 3.3</li> </ul>
4.2 No power transmitted	<ul style="list-style-type: none"> <li>– clutch A damaged beyond repair</li> <li>– fault in shift cable between selector lever and transmission</li> <li>– defective 1st gear freewheel</li> </ul>	<ul style="list-style-type: none"> <li>– fit an exchange transmission</li> <li>– check setting and adjust if necessary</li> <li>– fit an exchange transmission</li> </ul>
4.3 Violent jerk when shifting from N – D	<ul style="list-style-type: none"> <li>– engine idle speed &gt; 1500 min</li> <li>– see troubleshooting on hydraulic selector unit, item 2.2</li> </ul>	<ul style="list-style-type: none"> <li>– adjust to correct idle speed</li> <li>– ←</li> </ul>

## Troubleshooting – 5 HP 18 EH automatic transmission

<b>Malfunction</b>	<b>Possible cause</b>	<b>Remedial action</b>
<p>4.4 No shift action (whether warm or cold) Items 4.4.1 – 4.4.8</p>	<p>– see troubleshooting on hydraulic selector unit, items 2.4 – 2.4.8</p>	<p>– ←</p>
<p>4.1 No shift action from 1 – 2</p>	<p>– brakes C1 and C2 defective – inadequate oil supply to brakes C1 and C2</p>	<p>– fit an exchange transmission – fit an exchange transmission</p>
<p>4.4.2 No shift action from 2 – 1</p> <p>4.4.3 No shift action from 2 – 3</p>	<p>– see troubleshooting on hydraulic selector unit, item 2.4.2  – clutch F defective – inadequate oil supply to clutch F</p>	<p>– ←</p> <p>– fit an exchange transmission – fit an exchange transmission</p>
<p>4.4.4 No shift action from 3 – 2</p>	<p>– see troubleshooting on hydraulic selector unit, item 2.4.4</p>	<p>– ←</p>
<p>4.4.5 No shift action from 3 – 4</p>	<p>– clutch E defective – inadequate oil supply to clutch E</p>	<p>– fit an exchange transmission – fit an exchange transmission</p>
<p>4.4.6 No shift action No braking effect from 4 – 3</p>	<p>– brake band C2 defective; in this case 1 – 2 shift also not working correctly – inadequate oil supply to brake C2  – no preload at brake band C2 (spring broken; in this cas 1 – 2 shift also not working correctly)</p>	<p>– fit an exchange transmission  – fit an exchange transmission  – adjust the brake band</p>



## Troubleshooting – 5 HP 18 EH automatic transmission

<b>Malfunction</b>	<b>Possible cause</b>	<b>Remedial action</b>
4.4.7 No shift action from 4 – 5	– see item 4.4.5	– ←
4.4.8 No shift action from 5 – 4	– clutch A defective; in this case 1st to 4th gears also out of action	– fit an exchange transmission
4.5 Vehicle moves away in 2nd gear	– see troubleshooting on hydraulic selector unit, item 2.5	– ←
4.6 Vehicle moves away in 3rd gear	– see troubleshooting on hydraulic selector unit, item 2.6	– ←
4.7 Vehicle moves away 4th gear	– see troubleshooting on hydraulic selector unit, item 2.7	– ←
4.8 Shift transition off-load too violent	– see troubleshooting on hydraulic selector unit, item 2.8	– ←
4.9 Shift transitions at full load too violent	– see troubleshooting on hydraulic selector unit, item 2.9	– ←
4.10 Shift transitions at full load or kick-down take too long	– discs damaged – see troubleshooting on hydraulic selector unit, item 2.10	– fit an exchange transmission – ←

## Troubleshooting – 5 HP 18 EH automatic transmission

Malfunction	Possible cause	Remedial action
4.11 No downshifts when kick-down is operated	– see notes on troubleshooting for peripherals, item 1	– ←
4.12 Engine speed rises steeply during 2 – 3/ 3 - 2 shifts	– low friction at discs – see troubleshooting on hydraulic selector unit, item 2.11	– fit an exchange transmission – ←
4.13 Engine speed rises steeply during 4 – 5/ 5 - 4 shifts	– low friction at discs – see troubleshooting on hydraulic selector unit, item 2.12F	– fit an exchange transmission – ←
4.14 Engine speed rises steeply during 2 - 1 shifts	– low friction at discs – 1st gear freewheel not operating correctly	– fit an exchange transmission – fit an exchange transmission
4.15 Engine speed rises steeply during 4 - 3 shifts	– low friction at discs – 3rd gear freewheel not operating correctly	– fit an exchange transmission – fit an exchange transmission
<b>5. Position 4</b> 5.1 See items 4.4 – 4.4.6	– ←	– ←
5.2 No engine braking effect, no manual 5 - 4 downshift possible	– clutch A damaged – see troubleshooting on hydraulic selector unit, item 2.4.8 and notes on troubleshooting for peripherals, item 2	– fit an exchange transmission – ←

## Troubleshooting – 5 HP 18 EH automatic transmission

Malfunction	Possible cause	Remedial action
<p><b>6. Position 3</b> 6.1 See items 4.4 – 4.4.4</p>	<p>- ←</p>	<p>- ←</p>
<p>6.2 No engine braking effect, no manual 4 – 3 downshift possible</p>	<p>- see troubleshooting on hydraulic selector unit, item 2.4.6 and notes on troubleshooting for peripherals, item 2</p>	<p>- ← - ←</p>
<p><b>7. Position 2</b> 7.1 See items 4.4 – 4.4.2</p>	<p>- ←</p>	<p>- ←</p>
<p>7.2 No engine braking effect, no manual 3 - 2 downshift possible</p>	<p>- see troubleshooting on hydraulic selector unit, item 2.4.4 and notes on troubleshooting for peripherals, item 2</p>	<p>- ← - ←</p>
<p>7.3 No 1st gear, no braking effect</p>	<p>- brake D defective - see troubleshooting on hydraulic selector unit, item 2.4.2</p>	<p>- ← - ←</p>
<p><b>8. Converter lockup clutch (WK)</b> 8.1 Shifts too violent</p>	<p>- converter defective  - see troubleshooting on hydraulic selector unit, item 3.1</p>	<p>- fit an exchange converter  - ←</p>

## Troubleshooting – 5 HP 18 EH automatic transmission

<b>Malfunction</b>	<b>Possible cause</b>	<b>Remedial action</b>
8.2 Converter does not lock up	<ul style="list-style-type: none"> <li>– converter defective</li> <li>– see troubleshooting on hydraulic selector unit, items 3.2 and 3.4</li> </ul>	<ul style="list-style-type: none"> <li>– fit an exchange converter</li> <li>– ←</li> </ul>
8.3 Engine stalls when vehicle is halted with a gear selected (converter lock-up clutch does not open)	<ul style="list-style-type: none"> <li>– converter defective</li> <li>– see troubleshooting on hydraulic selector unit, item 3.3</li> </ul>	<ul style="list-style-type: none"> <li>– fit an exchange converter</li> <li>– ←</li> </ul>
<p><b>9. General</b></p> <p>9.1 No drive either forward or in reverse, loud noises</p>	<ul style="list-style-type: none"> <li>– pump impeller driver forced off</li> </ul>	<ul style="list-style-type: none"> <li>– fit an exchange converter</li> </ul>
9.2 Generally poor shift quality	<ul style="list-style-type: none"> <li>– see troubleshooting on hydraulic selector unit, item 4.4</li> </ul>	<ul style="list-style-type: none"> <li>– ←</li> </ul>
<p><b>10. Noise</b></p> <p>10.1 Noise in all positions (suction noise)</p>	<ul style="list-style-type: none"> <li>– oil level too low</li> <li>– selector unit leaking</li> <li>– oil filter blocked</li> <li>– missing or damaged O-ring seals at oil filter</li> </ul>	<ul style="list-style-type: none"> <li>– add oil to correct level</li> <li>– fit an exchange selector unit</li> <li>– fit an exchange oil filter</li> <li>– renew O-ring seals</li> </ul>
<p><b>11. Leaks</b></p> <p>11.1 Oil dripping from converter bell housing</p>	<ul style="list-style-type: none"> <li>– leaking usit rings</li> <li>– leaking shaft sealing ring</li> <li>– leakig O-ring</li> </ul>	<ul style="list-style-type: none"> <li>– renew usit rings</li> <li>– renew shaft sealing ring</li> <li>– renew O-ring</li> </ul>

## Troubleshooting – 5 HP 18 EH automatic transmission

<b>Malfunction</b>	<b>Possible cause</b>	<b>Remedial action</b>
11.2 Leakage between transmission housing and oil sump	<ul style="list-style-type: none"> <li>– damaged oil sump gasket</li> <li>– loose screw at oil sump</li> </ul>	<ul style="list-style-type: none"> <li>– renew gasket</li> <li>– take up stack at screws (tightening torque 6 Nm)</li> </ul>
11.3 Leakage at output side	<ul style="list-style-type: none"> <li>– shaft sealing ring at flange leaking</li> <li>– O-ring in transmission extension leaking</li> </ul>	<ul style="list-style-type: none"> <li>– renew shaft sealing ring</li> <li>– renew O-ring</li> </ul>
11.4 Leakage at selector shaft	<ul style="list-style-type: none"> <li>– shaft sealing ring leaking</li> </ul>	<ul style="list-style-type: none"> <li>– renew shaft sealing ring</li> </ul>
11.5 Loss of oil at transmission socket	<ul style="list-style-type: none"> <li>– nut loose</li> <li>– O-ring leaking</li> </ul>	<ul style="list-style-type: none"> <li>– retighten nut (tightening torque 20 Nm)</li> <li>– renew O-ring</li> </ul>
11.6 Leakage at screw plug of measuring union for $P_H$ - $P_{Mod}$ and clutches A, E, C2	<ul style="list-style-type: none"> <li>– bolts loose</li> <li>– sealing ring leaking</li> </ul>	<ul style="list-style-type: none"> <li>– retighten bolts (tightening torque 15 Nm)</li> <li>– renew sealing rings</li> </ul>
11.7 Leakage at screw plug for parking interlock pin	<ul style="list-style-type: none"> <li>– loose bolt</li> <li>– sealing ring damaged</li> </ul>	<ul style="list-style-type: none"> <li>– retighten bolt (tightening torque 32 Nm)</li> <li>– renew sealing ring</li> </ul>

**Troubleshooting – 5 HP 18 EH automatic transmission**

**NOTES**

--	--	--

## Troubleshooting – 5 HP 18 E 11 electronic-hydraulic selector unit

Malfunction	Possible cause	Remedial action
<p><b>1. Position R</b></p> <p>1.1 No drive in reverse</p>	<ul style="list-style-type: none"> <li>– signal line from MV3 short to earth (ground)</li> <li>– piston in reverse gear interlock valve not in rest position</li> </ul>	<ul style="list-style-type: none"> <li>– eliminate fault; if necessary renew wiring harness</li> <li>– eliminate fault; if necessary fit an exchange hydraulic selector unit</li> </ul>
<p>1.2 Violent jerk when selecting position R</p>	<ul style="list-style-type: none"> <li>– damping function of brake D not working correctly</li> <li>– modulation pressure too high</li> <li>– break in electric line to pressure regulator</li> <li>– defective pressure regulator</li> <li>– see notes on troubleshooting for peripherals, items 3 and 4</li> </ul>	<ul style="list-style-type: none"> <li>– check damping function</li> <li>– check function of modulation valve; if necessary renew housing</li> <li>– eliminate fault; if necessary renew wiring harness</li> <li>– fit an exchange pressure regulator (complete housing)</li> <li>– ←</li> </ul>
<p><b>2. Position D</b></p> <p>2.1 No forward drive</p>	<ul style="list-style-type: none"> <li>– damper A blocked</li> <li>– solenoid valve 5 signal line: short to earth (ground)</li> </ul>	<ul style="list-style-type: none"> <li>– check function of damper A</li> <li>– eliminate fault; if necessary, renew wiring harness</li> </ul>
<p>2.2 Violent jerk when position D is selected</p>	<ul style="list-style-type: none"> <li>– damping function of clutch A not working correctly</li> <li>– break in electric line to pressure regulator</li> </ul>	<ul style="list-style-type: none"> <li>– check damping function</li> <li>– eliminate fault; if necessary renew wiring harness</li> </ul>

## Troubleshooting – 5 HP 18 E 11 electronic-hydraulic selector unit

Malfunction	Possible cause	Remedial action
	<ul style="list-style-type: none"> <li>– defective pressure regulator</li> <li>– modulation valve malfunctioning</li> <li>– see notes on troubleshooting for peripherals, items 3 and 4</li> </ul>	<ul style="list-style-type: none"> <li>– fit an exchange pressure regulator (complete housing)</li> <li>– check modulation valve; if necessary renew complete housing</li> <li>– ←</li> </ul>
<p>2.3 Violent jerks with all shifts</p>	<ul style="list-style-type: none"> <li>– modulation valve malfunctioning</li> <li>– break in electric line to pressure regulator</li> <li>– defective pressure regulator</li> <li>– see notes on troubleshooting for peripherals, items 3 and 4</li> </ul>	<ul style="list-style-type: none"> <li>– check modulation valve; if necessary renew complete housing</li> <li>– eliminate fault; if necessary renew wiring harness</li> <li>– fit an exchange pressure regulator (complete housing)</li> <li>– ←</li> </ul>
<p>2.4 No shift action (whether warm or cold) items 2.4.1 – 2.4.8</p>	<ul style="list-style-type: none"> <li>– see notes on troubleshooting for peripherals, items 1 to 4</li> </ul>	<ul style="list-style-type: none"> <li>– ←</li> </ul>
<p>2.4.1 No shift action from 1 – 2</p>	<ul style="list-style-type: none"> <li>– Short circuit or break in line to output-side speed sensor</li> <li>– output-side speed sensor defective</li> <li>– solenoid valve 1 signal line: short to earth (ground)</li> <li>– shift valve 1 sticking in off position</li> <li>– damper C2 or clutch valve C1 blocked</li> <li>– shift valve 3 blocked in off position</li> </ul>	<ul style="list-style-type: none"> <li>– eliminate fault; if necessary, renew wiring harness</li> <li>– renew speed sensor</li> <li>– eliminate fault; if necessary, renew wiring harness</li> <li>– free shift valve</li> <li>– free damper or clutch valve</li> <li>– free the valve</li> </ul>



## Troubleshooting – 5 HP 18 E 11 electronic-hydraulic selector unit

<b>Malfunction</b>	<b>Possible cause</b>	<b>Remedial action</b>
2.4.2 No shift action from 2 – 1	<ul style="list-style-type: none"> <li>– line break at solenoid valve I (signal or positive line)</li> <li>– shift valve 1 sticking in extended position</li> <li>– solenoid valve I has a mechanical defect (no venting action)</li> </ul>	<ul style="list-style-type: none"> <li>– eliminate fault; if necessary renew wiring harness</li> <li>– free shift valve</li> <li>– fit a new solenoid valve 1</li> </ul>
2.4.3 No shift action from 2 – 3	<ul style="list-style-type: none"> <li>– solenoid valve 2 signal line: short to earth (ground)</li> <li>– shift valve 2 sticking in extended position</li> <li>– traction valve 2 – 3 blocked in rest position</li> <li>– damper F blocked</li> <li>– solenoid valve 2 has a mechanical defect (no venting action)</li> <li>– see notes on troubleshooting for peripherals, item 2</li> </ul>	<ul style="list-style-type: none"> <li>– eliminate fault; if necessary, renew wiring harness</li> <li>– free the valve</li> <li>– free the valve</li> <li>– free the damper</li> <li>– fit a new solenoid valve 2</li> <li>– ←</li> </ul>
2.4.4 No shift action from 3 – 2	<ul style="list-style-type: none"> <li>– line break at solenoid valve 2 (signal or positive line)</li> <li>– shift valve 2 sticking in rest position</li> <li>– traction valve 2 – 3 blocked in extended position</li> </ul>	<ul style="list-style-type: none"> <li>– eliminate fault; if necessary renew wiring harness</li> <li>– free the valve</li> <li>– free the valve</li> </ul>
2.4.5 No shift action from 3 – 4	<ul style="list-style-type: none"> <li>– solenoid valve 3 signal line: short to earth (ground)</li> <li>– solenoid valve 3 has a mechanical defect (no venting action)</li> <li>– shift valve 3 sticking in extended position</li> <li>– damper E sticking</li> <li>– see notes on troubleshooting for peripherals, item 2</li> </ul>	<ul style="list-style-type: none"> <li>– eliminate fault; if necessary, renew wiring harness</li> <li>– fit a new solenoid valve 3</li> <li>– free the valve</li> <li>– free the damper</li> <li>– ←</li> </ul>

## Troubleshooting – 5 HP 18 E 11 electronic-hydraulic selector unit

<b>Malfunction</b>	<b>Possible cause</b>	<b>Remedial action</b>
2.4.6 No shift action from 4 – 3	<ul style="list-style-type: none"> <li>– line break at solenoid valve 3 (signal or positive line)</li> <li>– shift valve 3 sticking in rest position</li> </ul>	<ul style="list-style-type: none"> <li>– eliminate fault; if necessary renew wiring harness</li> <li>– free the valve</li> </ul>
2.4.7 No shift action from 4 – 5	<ul style="list-style-type: none"> <li>– line break at solenoid valve I (signal or positive line)</li> <li>– shift valve 4 sticking in rest position</li> <li>– damper C2 blocked</li> <li>– see notes on troubleshooting for peripherals, item 2</li> </ul>	<ul style="list-style-type: none"> <li>– eliminate fault; if necessary renew wiring harness</li> <li>– free the valve</li> <li>– free the damper</li> <li>– ←</li> </ul>
2.4.8 No shift action from 5 – 4	<ul style="list-style-type: none"> <li>– solenoid valve 1 signal line: short to earth (ground)</li> <li>– shift valve 4 sticking in extended position</li> <li>– solenoid valve 1 has a mechanical defect (no venting action)</li> </ul>	<ul style="list-style-type: none"> <li>– eliminate fault; if necessary renew wiring harness</li> <li>– free the valve</li> <li>– fit a new solenoid valve 1</li> </ul>

## Troubleshooting – 5 HP 18 E 11 electronic-hydraulic selector unit

<b>Malfunction</b>	<b>Possible cause</b>	<b>Remedial action</b>
2.5 Vehicle moves away in 2nd gear	<ul style="list-style-type: none"> <li>– line break at solenoid valve 1 (signal or positive line); in this 5th gear also unobtainable</li> <li>– shift valve 1 sticking in rest position</li> <li>– see notes on troubleshooting for peripherals, item 2</li> </ul>	<ul style="list-style-type: none"> <li>– eliminate fault; if necessary renew wiring harness</li> <li>– free the valve</li> <li>– ←</li> </ul>
2.6 Vehicle moves away in 3rd gear	<ul style="list-style-type: none"> <li>– line break at solenoid valve 1 + 2 (signal or positive line)</li> <li>– shift valves 1 + 2 sticking in rest position</li> <li>– see notes on troubleshooting for peripherals, item 2</li> </ul>	<ul style="list-style-type: none"> <li>– eliminate fault; if necessary renew wiring harness</li> <li>– free the valves</li> <li>– ←</li> </ul>
2.7 Vehicle moves away in 4th gear	<ul style="list-style-type: none"> <li>– line break at all positive lines (no electric power reaching transmission)</li> <li>– shift valves 1, 2 + 3 sticking in rest position</li> </ul>	<ul style="list-style-type: none"> <li>– eliminate fault; if necessary renew wiring harness</li> <li>– free the valves</li> </ul>
2.8 Off-load shift transitions too violent	<ul style="list-style-type: none"> <li>– modulation valve malfunctioning</li> <li>– break in line to pressure regulator</li> <li>– pressure regulator malfunctioning (the adjusting screw setting may be incorrect)</li> <li>– damper malfunction</li> <li>– see notes on troubleshooting for peripherals, item 3</li> </ul>	<ul style="list-style-type: none"> <li>– check modulation valve function</li> <li>– check wiring harness, renew if necessary</li> <li>– renew pressure regulator (complete housing)</li> <li>– check damper function</li> <li>– ←</li> </ul>

## Troubleshooting – 5 HP 18 E 11 electronic-hydraulic selector unit

<b>Malfunction</b>	<b>Possible cause</b>	<b>Remedial action</b>
<p>2.9 Full-load shift transitions too violent</p>	<ul style="list-style-type: none"> <li>– modulation valve malfunctioning</li> <li>– break in line to pressure regulator</li> <li>– pressure regulator malfunctioning (the adjusting screw setting may be incorrect)</li> <li>– damper malfunction</li> <li>– see notes on troubleshooting for peripherals, item 3</li> </ul>	<ul style="list-style-type: none"> <li>– check modulation valve function</li> <li>– check wiring harness, renew if necessary</li> <li>– renew pressure regulator (complete housing)</li> <li>– check damper function</li> <li>– ←</li> </ul>
<p>2.10 Full-load and kick-down shift transitions take too long</p>	<ul style="list-style-type: none"> <li>– pressure reducing valve 1 or 2 malfunctioning</li> <li>– modulation valve malfunctioning</li> <li>– defective pressure regulator</li> <li>– see notes on troubleshooting for peripherals, item 3</li> </ul>	<ul style="list-style-type: none"> <li>– check function of pressure reducing valve</li> <li>– check function of modulation valve</li> <li>– renew pressure regulator (complete housing)</li> <li>– ←</li> </ul>
<p>2.11 Engine speed rises steeply during 2 – 3/ 3 – 2 shifts (overlap control)</p>	<ul style="list-style-type: none"> <li>– line break at solenoid valve 4 (signal or positive line)</li> <li>– solenoid valve 4 defective</li> <li>– traction-coasting valve 1 stiff</li> <li>– gate for damper G blocked</li> <li>– damper F stiff</li> <li>– traction valve 2 – 3 stiff</li> <li>– traction valve 3 – 2 stiff</li> </ul>	<ul style="list-style-type: none"> <li>– eliminate fault; if necessary renew wiring harness</li> <li>– renew solenoid valve</li> <li>– free the valve</li> <li>– clean the gate</li> <li>– free the damper</li> <li>– free the valve</li> <li>– free the valve</li> </ul>

**Troubleshooting – 5 HP 18 E 11 electronic-hydraulic selector unit**

<b>Malfunction</b>	<b>Possible cause</b>	<b>Remedial action</b>
<p>2.12 Engine speed rises steeply during 4 – 5/5 – 4 shifts (overlap control)</p>	<ul style="list-style-type: none"> <li>– line break at solenoid valve 5 (signal or positive line)</li> <li>– solenoid valve 5 defective</li> <li>– traction-coasting valve 2 stiff</li> <li>– damper C2 malfunctioning</li> <li>– traction valve 4 – 5 stiff</li> <li>– traction valve 5 – 4 stiff</li> <li>– damper A stiff</li> </ul>	<ul style="list-style-type: none"> <li>– eliminate fault; if necessary renew wiring harness</li> <li>– renew solenoid valve</li> <li>– free the valve</li> <li>– check damper function</li> <li>– free the valve</li> <li>– free the valve</li> <li>– free the damper</li> </ul>
<p>2.13 Engine speed rises steeply during 1 – 2/ 2 – 1 shifts (freewheel control)</p>	<ul style="list-style-type: none"> <li>– see automatic transmission troubleshooting, item 4.14</li> </ul>	<p>– ←</p>
<p>2.14 Engine speed rises steeply during 3 – 4/ 4 – 3 shifts (freewheel control)</p>	<ul style="list-style-type: none"> <li>– see automatic transmission troubleshooting, item 4.15</li> </ul>	<p>– ←</p>
<p><b>3. Converter lockup clutch (WK)</b> 3.1 Shift transitions too violent</p>	<ul style="list-style-type: none"> <li>– converter lockup valve malfunctioning</li> </ul>	<ul style="list-style-type: none"> <li>– check function of valve</li> </ul>

## Troubleshooting – 5 HP 18 E 11 electronic-hydraulic selector unit

<b>Malfunction</b>	<b>Possible cause</b>	<b>Remedial action</b>
3.2 No converter lock-up	<ul style="list-style-type: none"> <li>– line break at solenoid valve 6 (signal or positive line)</li> <li>– solenoid valve 6 defective</li> </ul>	<ul style="list-style-type: none"> <li>– eliminate fault; if necessary renew wiring harness</li> <li>– renew solenoid valve</li> </ul>
3.3 Engine stalls when vehicle is halted in gear (lock-up clutch does not open)	<ul style="list-style-type: none"> <li>– short to earth (ground) at solenoid valve 6 signal line</li> <li>– lock-up valve sticking in extended</li> <li>– solenoid valve 6 has a mechanical defect (no venting action)</li> </ul>	<ul style="list-style-type: none"> <li>– eliminate fault; if necessary renew wiring harness</li> <li>– free the valve position</li> <li>– fit a new solenoid valve</li> </ul>
3.4 Shift speed incorrect	<ul style="list-style-type: none"> <li>– temperature sensor malfunctioning</li> </ul>	<ul style="list-style-type: none"> <li>– renew the wiring harness</li> </ul>
<b>4. General</b>		
4.1 No lubricating oil pressure	<ul style="list-style-type: none"> <li>– lubricating pressure valve malfunctioning (clogged with dirt)</li> </ul>	<ul style="list-style-type: none"> <li>– check lubricating pressure valve</li> </ul>
4.2 No converter pressure	<ul style="list-style-type: none"> <li>– converter pressure valve malfunctioning (clogged with dirt)</li> </ul>	<ul style="list-style-type: none"> <li>– check converter pressure valve</li> </ul>
4.3 No main pressure	<ul style="list-style-type: none"> <li>– main pressure valve malfunctioning (clogged with dirt)</li> </ul>	<ul style="list-style-type: none"> <li>– check main pressure valve</li> </ul>
4.4 Generally poor shift quality	<ul style="list-style-type: none"> <li>– defective temperature sensor</li> </ul>	<ul style="list-style-type: none"> <li>– renew wiring harness</li> </ul>

**Troubleshooting – 5 HP 18 EH electronic-hydraulic selector unit**

**NOTES**

--	--	--

## Troubleshooting – 5 HP 18 E 11 – peripherals

Malfunction	Possible cause	Remedial action
<p><b>1) Kick-down (KD) switch</b></p> <p>a) Short to earth (ground)</p>	<p>– larger than half load (only KD circuits)</p> <p>– smaller than half-load (normal shift points) (the fault is stored in the fault memory with no external identification)</p>	<p>– eliminate fault; if necessary renew</p> <p>– kick-down switch or vehicle wiring harness</p>
<p>b) Line break (open circuit)</p>	<p>– no KD shifts, only part/full-load shifts</p>	<p>– eliminate fault; if necessary renew vehicle wiring harness</p>
<p>c) Switch defective</p>	<p>– possibly undefined shifts („hunting”)</p>	<p>– renew the switch</p>
<p><b>2) Position switch (selector lever)</b></p> <p>a) Break in signal line for D, 4, 3 or 2</p>	<p>– no shifts, vehicle remains in selected gear</p>	<p>– eliminate fault; if necessary renew vehicle wiring harness</p>
<p>b) No positive power supply (fuse blown)</p>	<p>– no shifts, vehicle remains in selected gear</p>	<p>– renew the fuse</p>
<p>c) Short-circuit between signal lines D, 4, 3 or 2</p>	<p>– „Manual shift” signal to EGS. No upshift because of short-circuited line e.g. selector lever at D, short circuit to position 4, shift 4 - 5 is prevented</p>	<p>– eliminate fault; if necessary renew vehicle wiring harness or selector lever switch</p>
<p><b>3) Potentiometer at accelerator pedal (EML) or throttle butterfly</b></p> <p>a) Accelerator pedal setting too slack</p>	<p>– incorrect shift points</p>	<p>– correct setting of accelerator pedal</p>



## Troubleshooting – 5 HP 18 E 11 – peripherals

<b>Malfunction</b>	<b>Possible cause</b>	<b>Remedial action</b>
b) Accelerator pedal preload too high	– incorrect shift points	– correct setting of accelerator pedal
c) Potentiometer defective	– possibly undefined shifts („hunting”)	– renew potentiometer
<b>4) Program switch</b> a) Break in S program signal line or short-circuit to positive side	– S program not available	– eliminate fault; if necessary renew vehicle wiring harness
b) S program signal line: short to earth (ground)	– only S program available („S” displayed)	– eliminate fault; if necessary renew vehicle wiring harness
c) Break in W program signal line or short-circuit to positive side	– W program not available	– eliminate fault; if necessary renew vehicle wiring harness
d) W program signal line: short to earth (ground)	– only W (winter) program available („W” displayed)	– eliminate fault; if necessary renew vehicle wiring harness

**Troubleshooting – 5 HP 18 EH – peripherals**

**NOTES**

--	--	--

## **1.7. Checking the transmission**

The following points must be checked:

### **Oil level correct**

Comply with the vehicle manufacturer's instructions.

### **Oil level too low**

The engine will overspeed when the vehicle is cornered, there will be valve chatter as a result of air inclusions and general malfunctioning of the transmission.

### **Oil level too high**

Risk of severe splash losses and foaming, severe rise in temperature if driven fast. Oil lost through breather.

### **Correct engine settings**

Correct idle speed (comply with vehicle manufacturer's instructions).

### **Drive taken up forwards and in reserve**

Selector linkage or cables correctly adjusted (comply with vehicle manufacturer's instructions).

### **Shift quality**

See troubleshooting table



### **Noise**

See troubleshooting table

### **Fault memory**

If activated, comply with vehicle manufacturer's instructions.

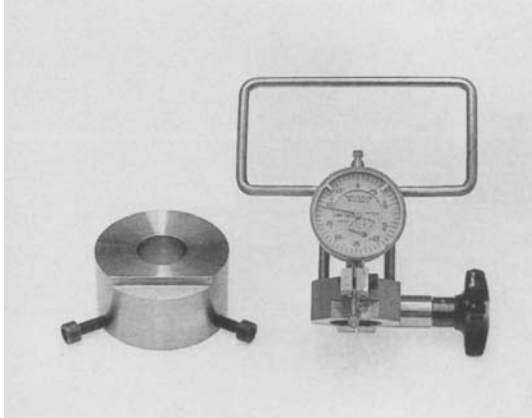

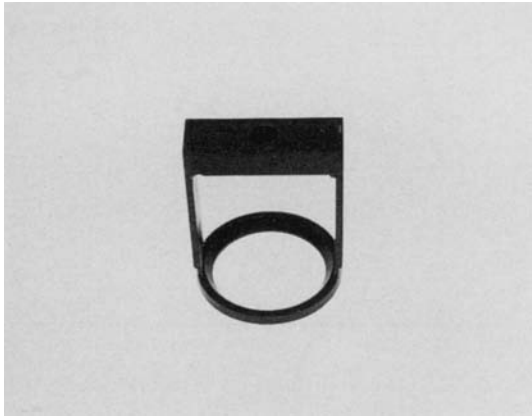
**1.8 Special tools 5 HP 18**

Pic. No.	Item	Order No. / purpose	Remarks
1	<p><b>82 183</b></p> 	<p>5 P 01 001 415 – End play measuring device</p>	<p>identical with 4 HP 22</p>
2	<p><b>91 186</b></p> 	<p>5 P 01 002 028 – Brake band adjustment measuring device</p>	
3	<p><b>84 258</b></p> 	<p>5 X 46 000 167 – Assembly aid</p>	<p>identical with 4 HP 14 4 HP 18 Q 4 HP 22</p>

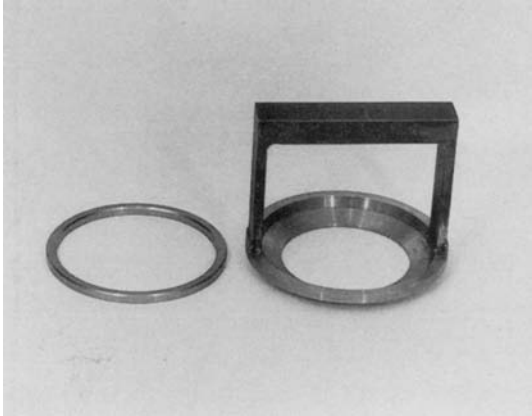
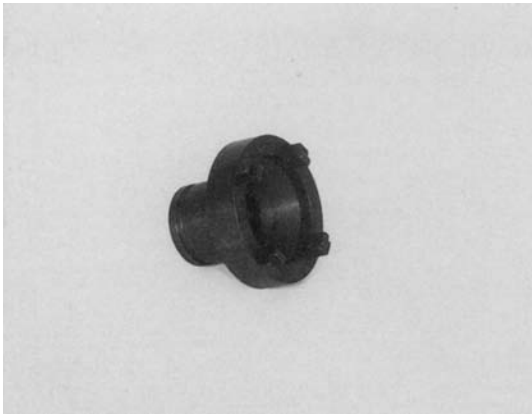
**1.8 Special tools 5 HP 18**

Pic. No.	Item	Order No. / purpose	Remarks
4	<p><b>85 417</b></p> 	<p>5 X 46 000 221                      – Assembly fixture for diaphragm spring, clutch B</p>	<p>identical with 4 HP 18 Q</p>
5	<p><b>88 258</b></p> 	<p>5 X 46 000 312                      – Centering device for C 1 lined discs</p>	<p>identical with 4 HP 18 FL</p>
6	<p><b>91 187</b></p> 	<p>5 X 46 000 541                      – Socked wrench for slotted nut</p>	

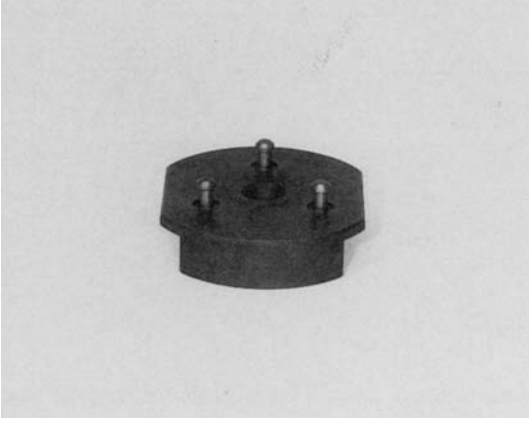
**1.8 Special tools 5 HP 18**

Pic. No.	Item	Order No. / purpose	Remarks
7	<p><b>91 188</b></p> 	<p>5 X 46 000 542 - Retainer for output flange</p>	
8	<p><b>91 189</b></p> 	<p>5 X 46 000 545 - Lifter for tower</p>	
9	<p><b>91 190</b></p> 	<p>5 X 46 000 563 - Removal fixture for complete oil supply unit</p>	

**1.8 Special tools 5 HP 18**

Pic. No.	Item	Order No. / purpose	Remarks
10	<p><b>91 191</b></p> 	<p>5 X 46 000 574                      – Assembly fixture for piston C 2 brake band</p>	
11	<p><b>91 192</b></p> 	<p>5 X 46 000 576                      – Assembly device for snap ring D-G/F</p>	
12	<p><b>91 193</b></p> 	<p>5 X 46 000 577                      – Counter- holder for 1st gear freewheel</p>	

**1.8 Special tools 5 HP 18**

Pic. No.	Item	Order No. / purpose	Remarks
13	<p><b>91 194</b></p> 	<p>5 X 46 000 620 - Assembly clamp</p>	
14	<p><b>78 085</b></p> 	<p>5 X 46 000 680 - Assembly sleeve for pump shaft sealing ring</p>	
15	<p><b>91 195</b></p> 	<p>5 X 46 000 685 - Driver for selector shaft clamp sleeve</p>	

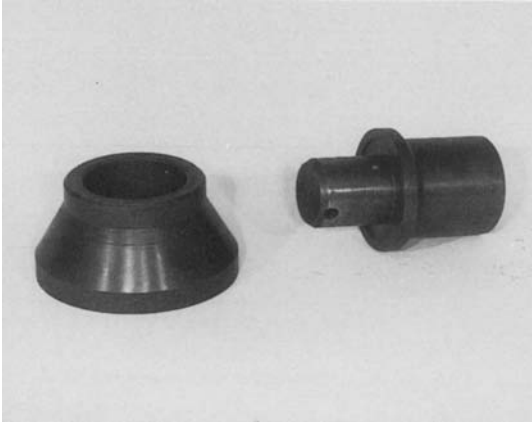

**1.8 Special tools 5 HP 18**

Pic. No.	Item	Order No. / purpose	Remarks
16	<p><b>91 196</b></p> 	<p>5 X 46 000 737                      – Pressing-in tool for selector shaft sealing ring</p>	
17	<p><b>91 197</b></p> 	<p>5 X 46 000 760                      – Pressing-in tool for ball thrust bearing, transmission extension</p>	
18	<p><b>91 198</b></p> 	<p>5 X 46 000 761                      – Pressing-in for shaft sealing ring, transmission extension</p>	

**1.8 Special tools 5 HP 18**

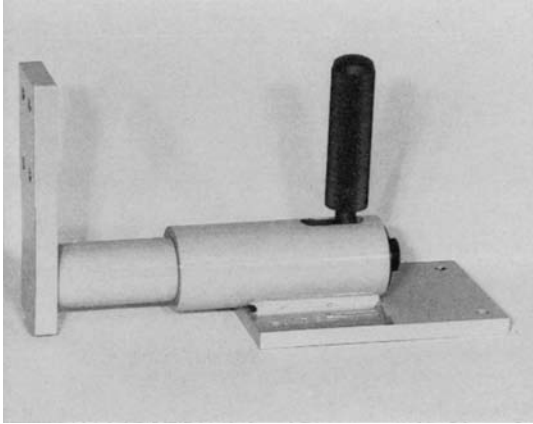
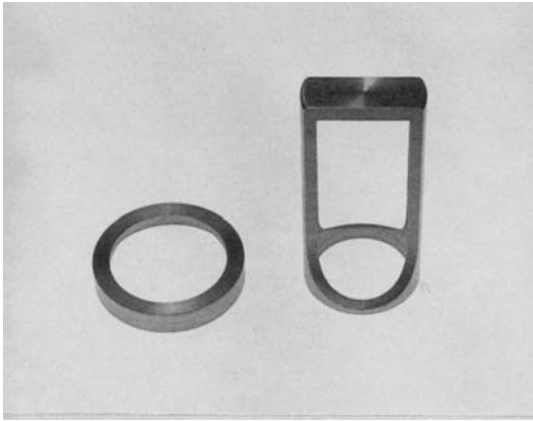
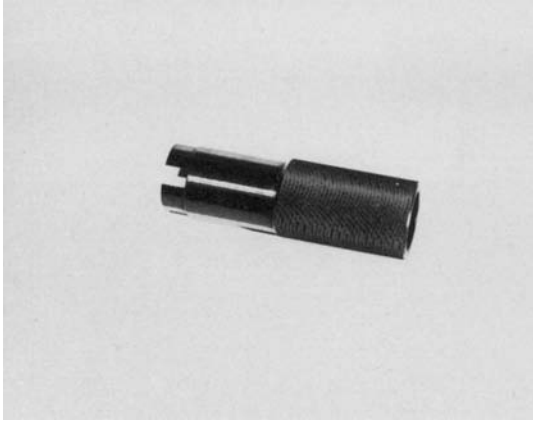
Pic. No.	Item	Order No. / purpose	Remarks
19	<p><b>91 199</b></p> 	<p>5 X 46 000 763                      – Workbench holder for assembly clamp</p>	
20	<p><b>84 260</b></p> 	<p>5 X 46 000 863                      – Assembly device for diaphragm spring, clutch E</p>	
21	<p><b>84 258</b></p> 	<p>5 X 56 000 021                      – Pump testing sleeve</p>	<p>identical with                      3 HP 22                      4 HP 22</p>

**1.8 Special tools 5 HP 18**

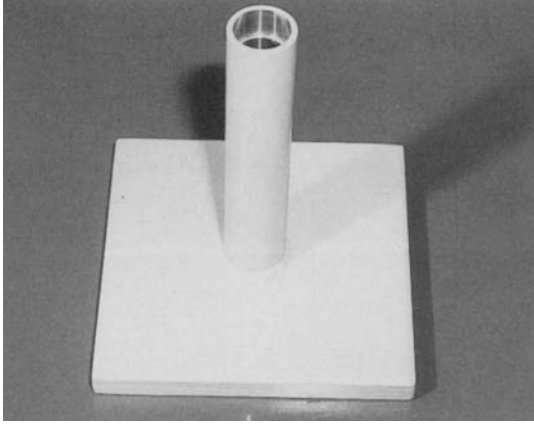
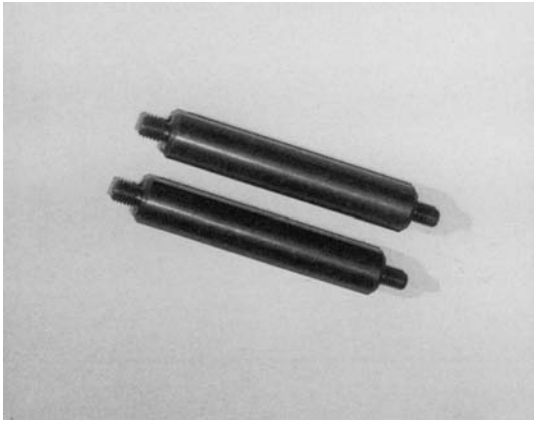
Pic. No.	Item	Order No. / purpose	Remarks
22	<p><b>76 050</b></p> 	<p>5 X 56 000 072 – Mounting for tower</p>	<p>identical with 3 HP 22 4 HP 22</p>
23	<p><b>76 046</b></p> 	<p>5 X 56 000 090 – Handles for pulling out converter</p>	<p>identical with 3 HP 22 4 HP 22</p>

## 2. Dismantling

91 001

### 2.1 Dismantling the transmission according to assembly groups

Place the complete transmission in assembly clamp 5 X 46 000 620, remove the converter retaining hoop and pull out the converter by screwing in the two handles 5 X 56 000 090.

**Warning:** Oil will escape

Avoid damage to converter bearings and shaft sealing ring.

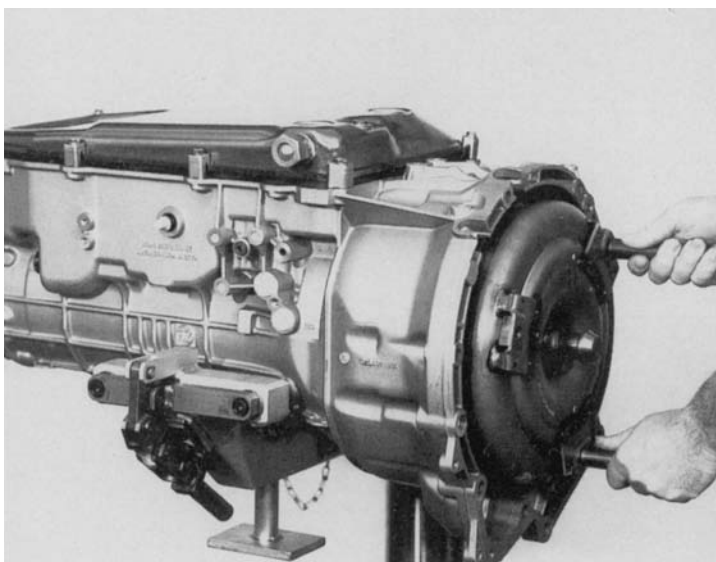

91 002

Take out the bolts holding the oil sump and detach the sump with its gasket. (Wrench size = 10 mm)

Note:

Different patterns of oil sump may be fitted. The dipstick connection has been deleted.

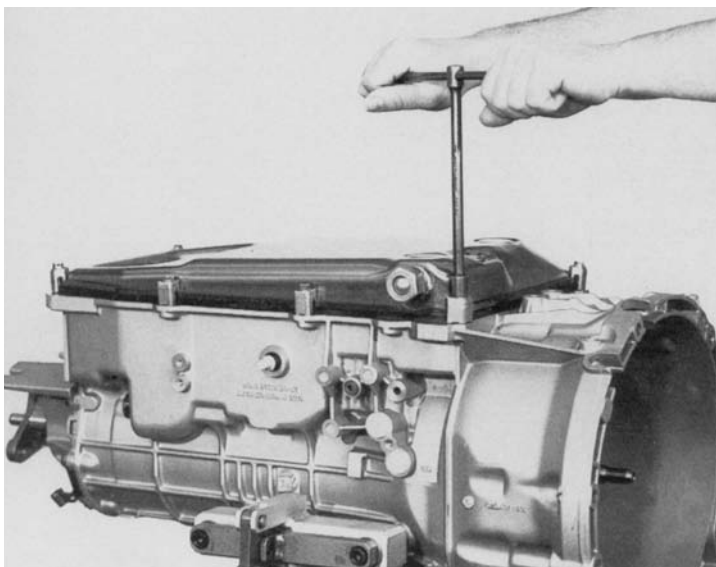

91 003

Remove the oil strainer by taking out the 3 machine screws.

(Torx socket wrench insert = TX 27)

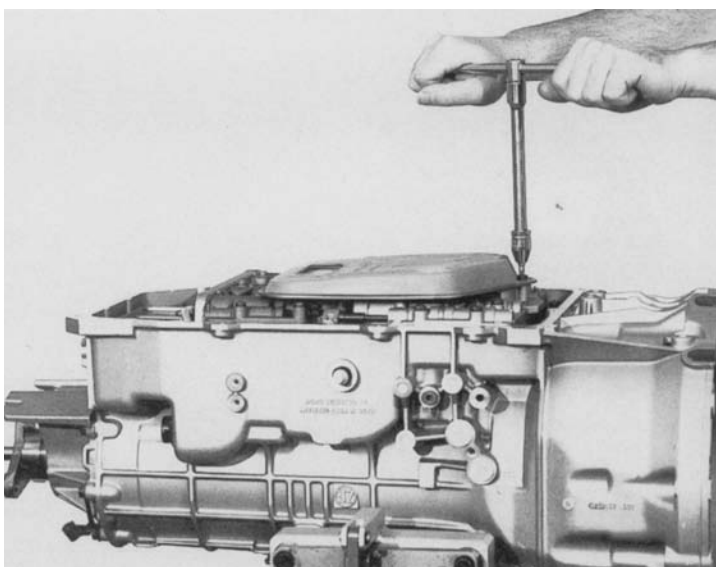

91 004

Detach the socket for the wiring harness and press it inwards.  
(Wrench size = 32 mm)

Take out all the bolts with the larger head, and lift off the complete control unit, including the cover plate.

(Wrench size = Torx socket wrench insert TX 27)

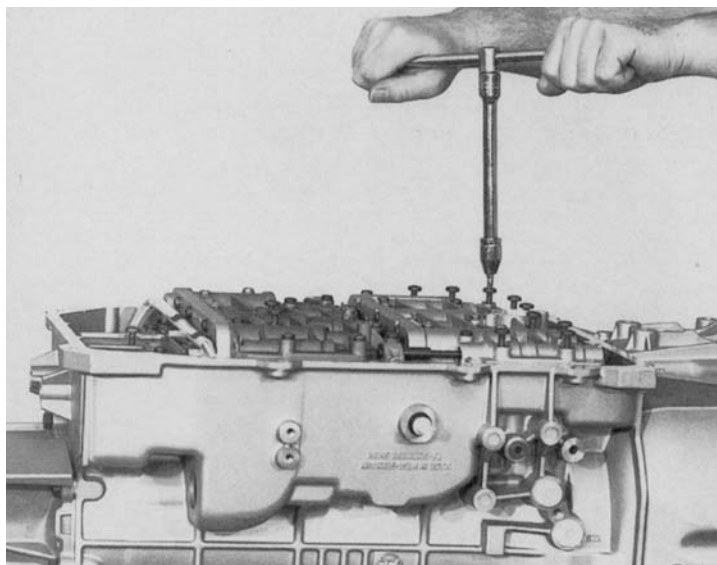

91 005

Turn the transmission through 90 degrees and unscrew the oil supply unit (consisting of pump, intermediate plate and brake C<sup>1</sup>); to do this, remove the 9 machine screws with their usit rings.

(Wrench size = Torx TX 27)

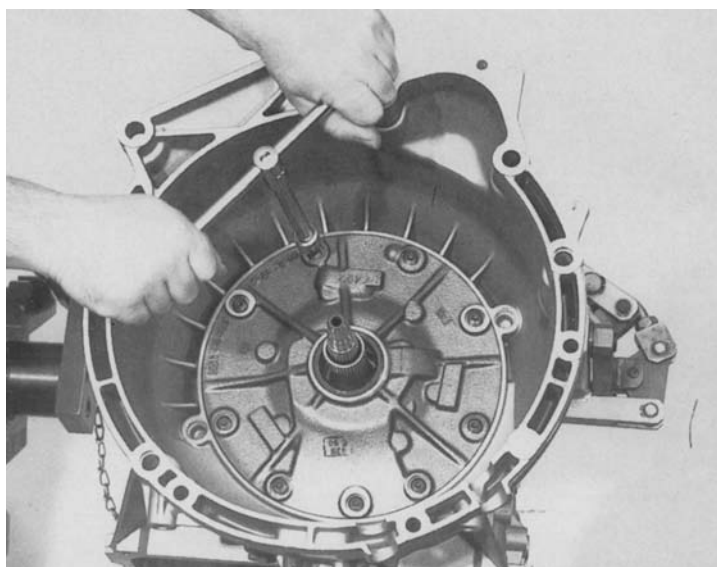

91 006

Clamp assembly fixture 5 X 46 000 563 on to the stator shaft. Screw down the spindle on the fixture to release and lift off the complete unit.

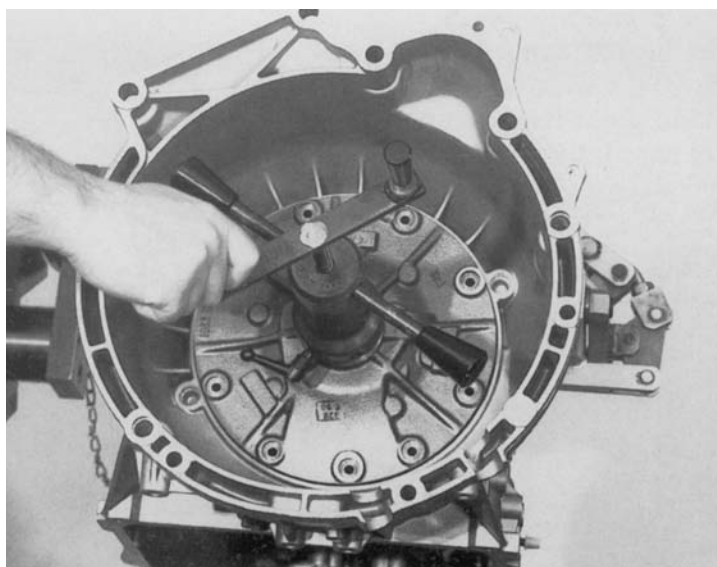

91 007

**Warning:** do not turn the transmission any further.

Remove the angled disc, needle roller thrust bearing and shim washer. Note that the angled disc may stick to the intermediate plate.

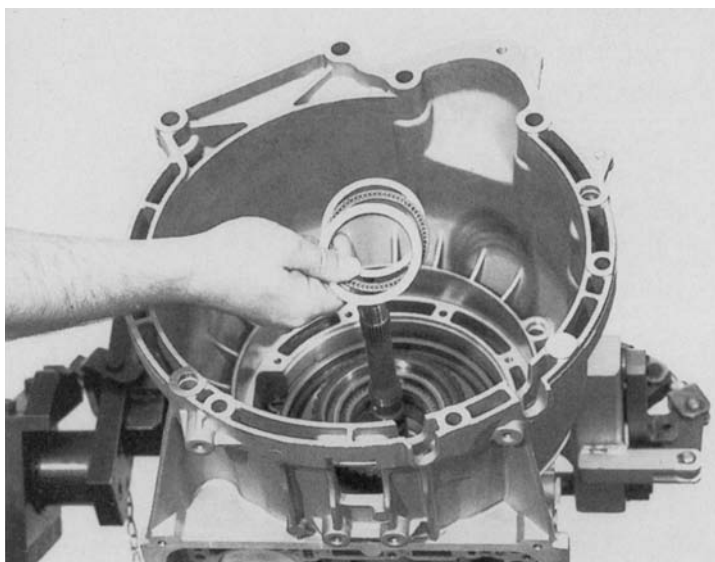

91 008

Remove the input side with clutches A, B and E.

At the input shaft, take out the complete unit consisting of clutch A, clutch B with 2nd gear freewheel and clutch E. While doing so, hold the brake band firmly to prevent it from tilting.

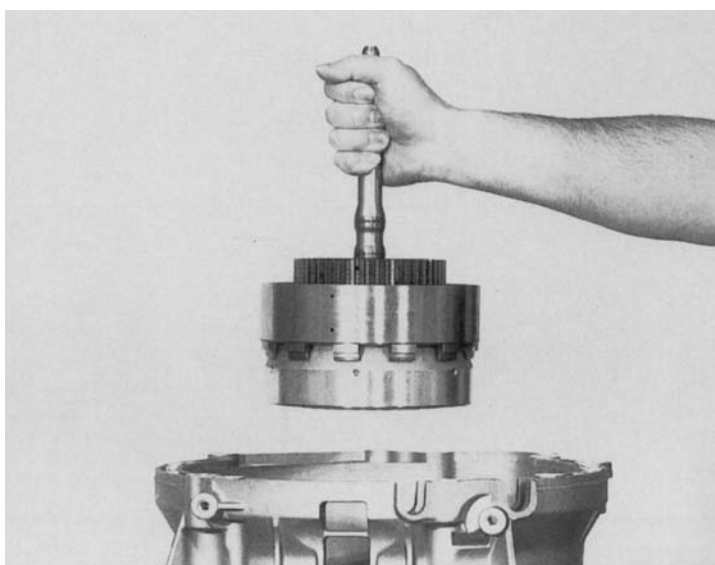

91 009

Take out the brake band opposite the brake plates. When removing, make sure that the brake band is not bent outwards; to prevent this, use retaining clip (also indicates "top").

**Important:**

Make sure that the brake band is not turned over accidentally when it is installed again.

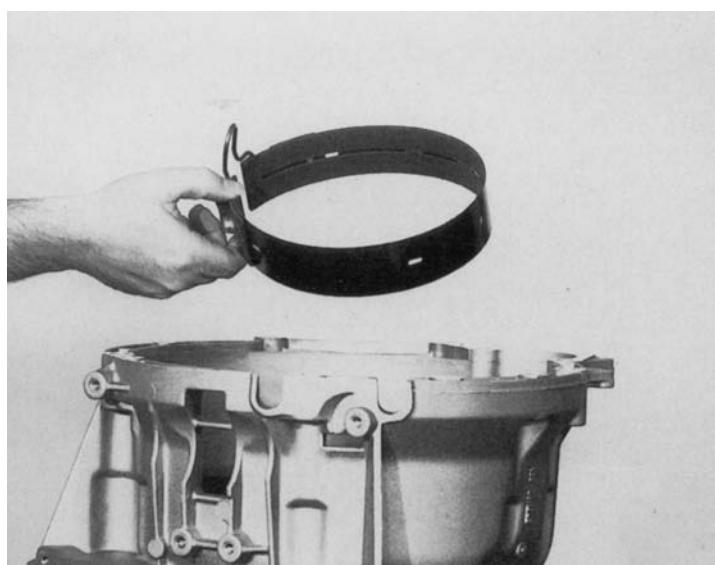

91 010

Take out the intermediate shaft complete with 2 thrust washers and 1 axial (AX) needle roller cage.

**Warning:**

It is quite possible when removing axial bearings that the washers will remain sticking to the opposing running face.

It is always desirable to keep the bearings completely assembled.

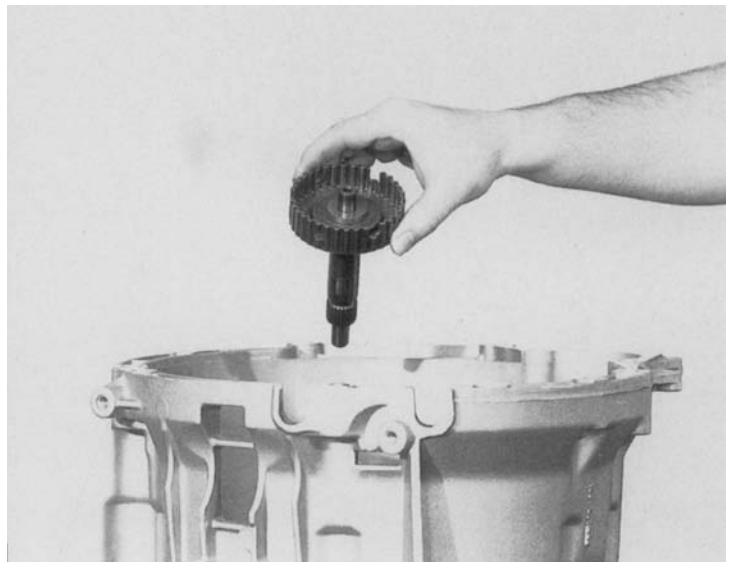

91 011

Remove the sun wheel shaft complete with thrust bearing, one thrust washer and one angled disc.



91 012

Remove case with thrust bearing, one washer and one angled disc.

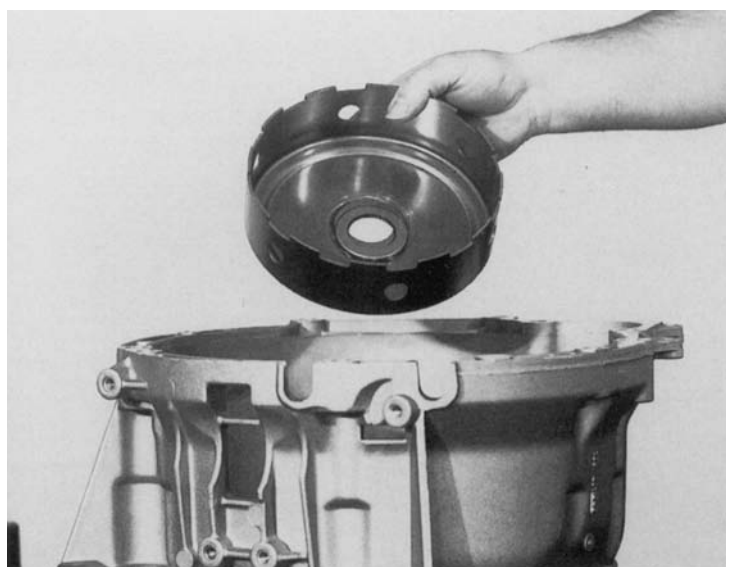

91 013

Lift off the sun wheel.



91 014

After this the complete planet spider, the thrust bearing, one washer and one angled disc can be removed.



91 015

Pull out the shaft complete with the hollow gear.

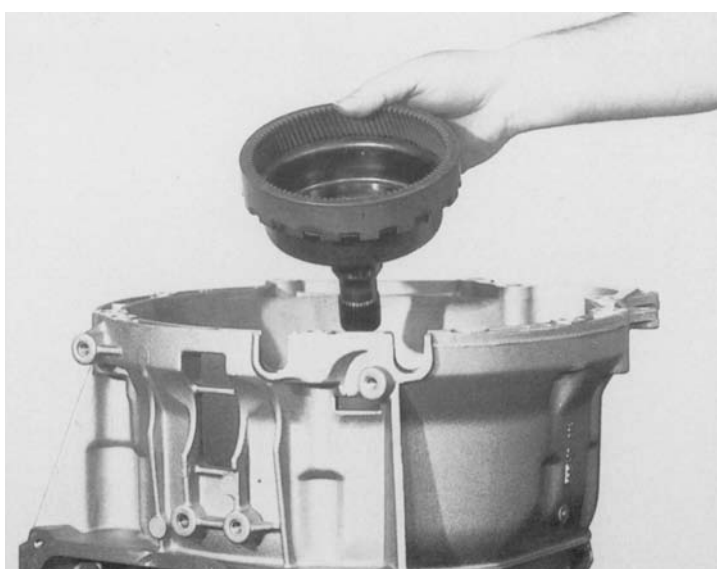



91 016

Remove the spider case.  
Take out the thrust washer,  
needle roller cage and angled disc.



91 017

To remove the complete planetary  
gear set, first take out the  
3 machine screws.  
(Wrench size = Torx TX-50)

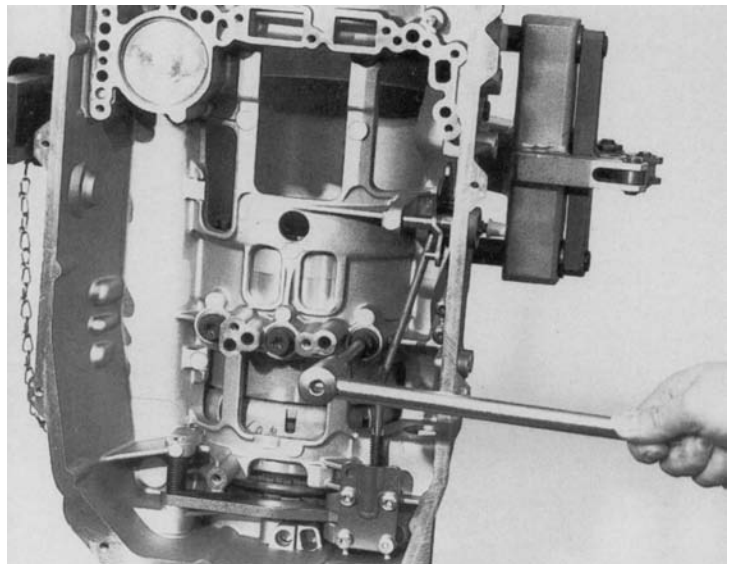

91 018

Insert lifter 5 X 46 000 545 into  
the planet wheel carrier of the tower  
and press the tensioner down to locate  
it centrally.

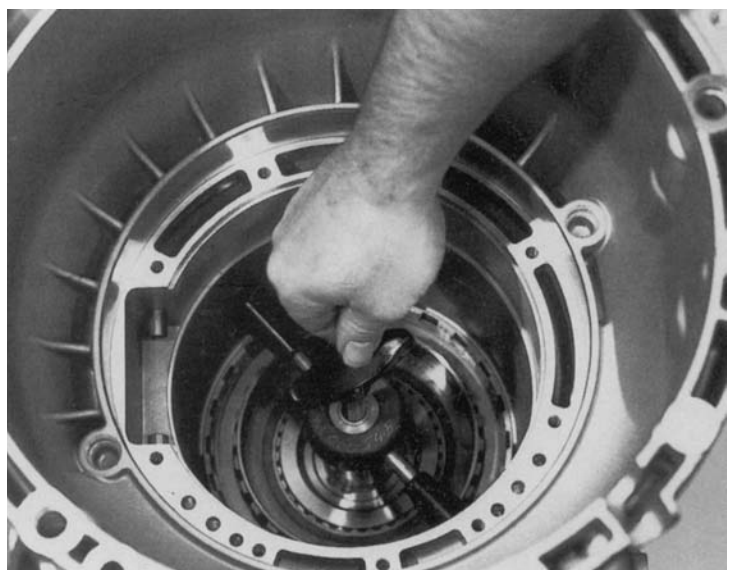

91 019

Lift out the complete tower and insert it into mounting 5 X 56 000 072.  
Remove the shim washer.

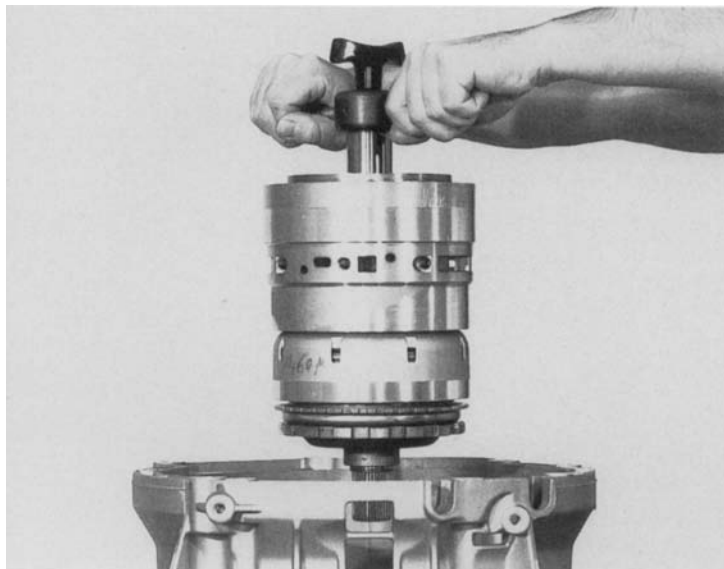

91 020

Turn the transmission through 90 degrees and take out the 7 hex bolts.  
The output side cannot be pulled off until these bolts have been removed.  
(Wrench size = 13 mm)

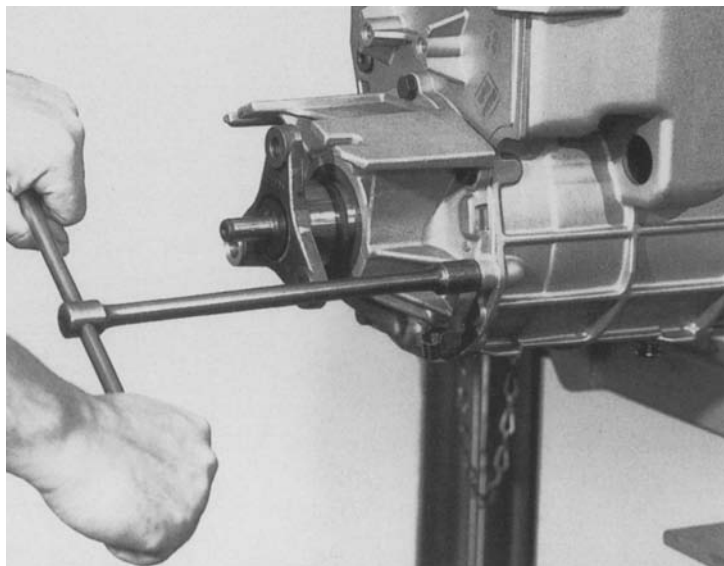

91 021

## 2.2 Output side

Place the output side on retainer 5 X 46 000 542. Clamp the retainer into the vise.

### **Warning:**

Different patterns are possible.

Pull the O-ring off the extension.



91 022

Release the slotted nut with a suitable chisel, and unscrew it with slotted nut wrench 5 X 46 000 541. After this, the output flange can be pulled off.

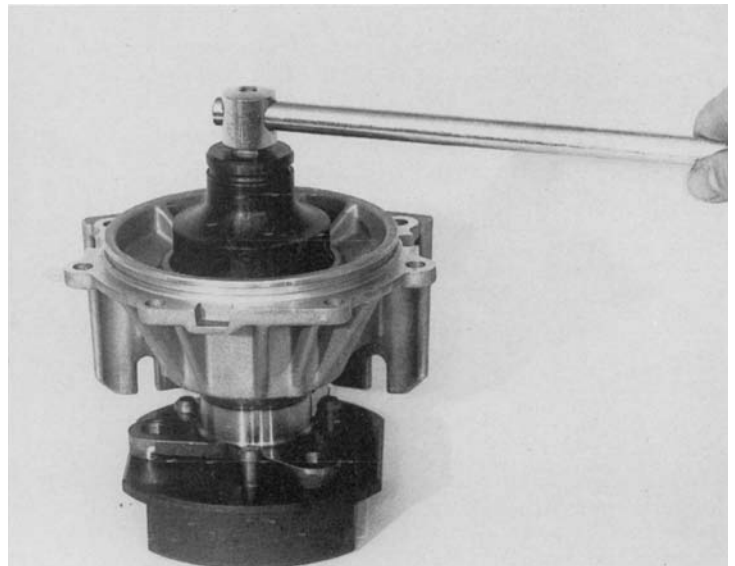

91 023

Remove the snap ring with suitable pliers. After this, press out the ball bearing in an mandrel press.

**Warning:**

The two inner bearing races must not be accidentally mixed up.

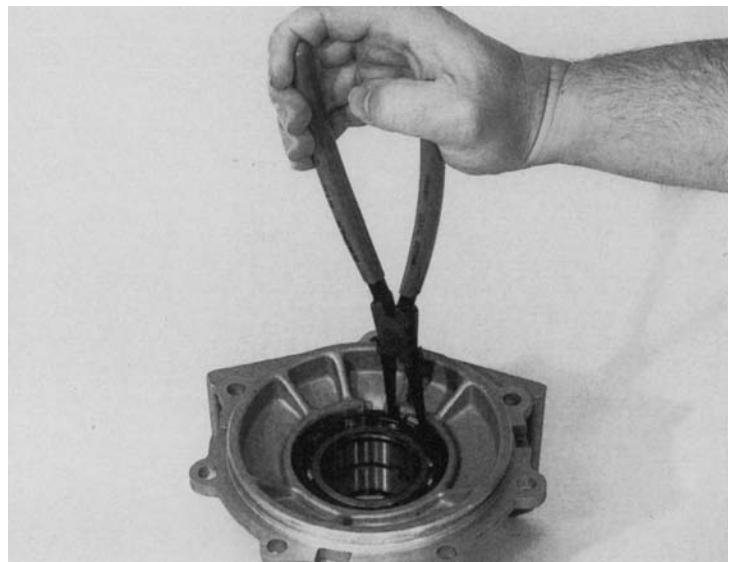

91 024

Drive out the shaft sealing ring with a suitably shaped punch.

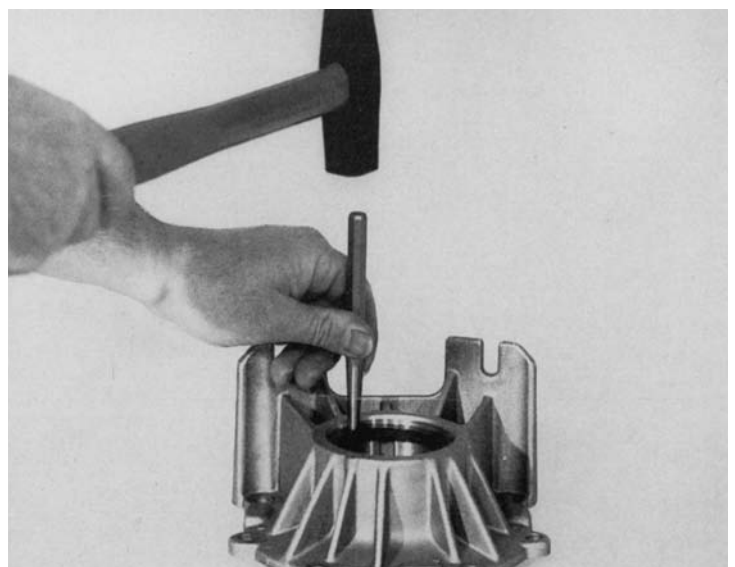

## 2.3 Planetary gears, complete

91 025

### 2.3.1 Planetary gear set III

Before planetary gear set III can be taken off, the complete planetary gear assembly (tower) must be subdivided into the components brake D-G, clutch F and planetary gear set III.

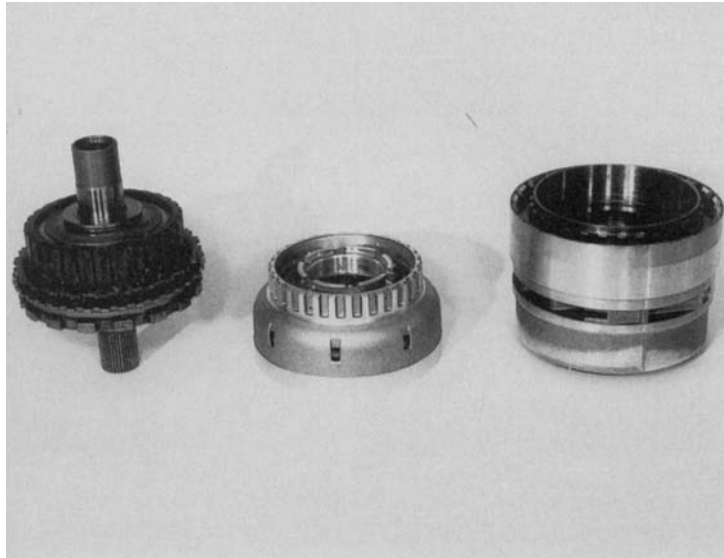

Remove the angled disc, needle roller thrust bearing and thrust washer. Lift off the hollow gear carrier.

91 026

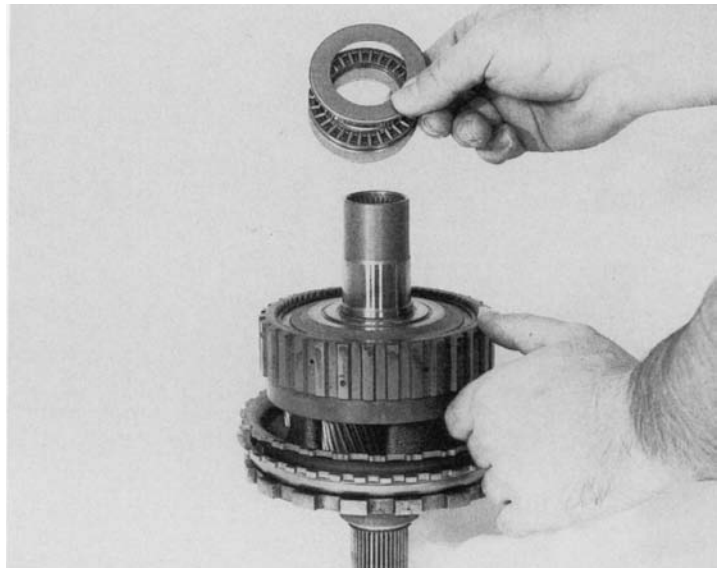

The hollow gear can be separated from its carrier by removing the snap ring.

91 027



91 028

Turn the planet carrier round and remove the angled disc, needle roller thrust bearing and thrust washer.

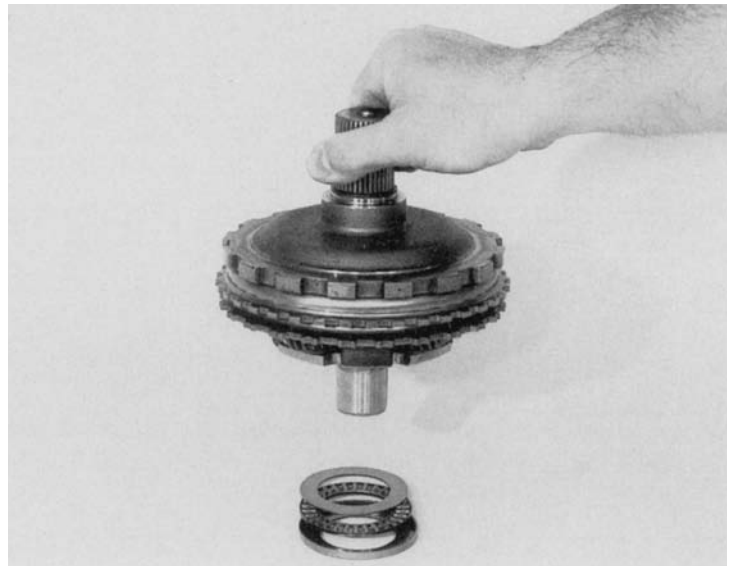

91 029

Take out the snap ring and lift off the parking pawl gear. Remove the thrust washer, angled disc and needle roller thrust bearing.

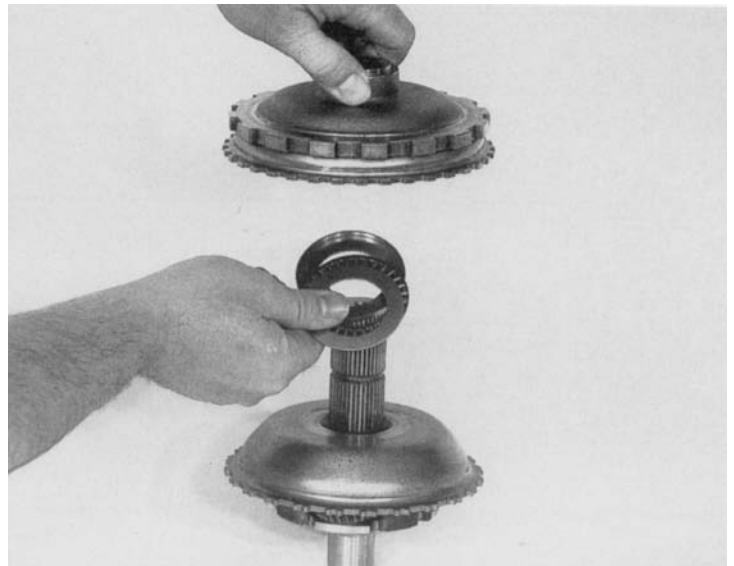

91 030

Take off the sun wheel. Underneath it are an angled disc, a needle roller thrust bearing and another angled disc.



### 2.3.2 Clutch F

91 031

Take out the snap ring and remove the complete disc cluster of clutch F.

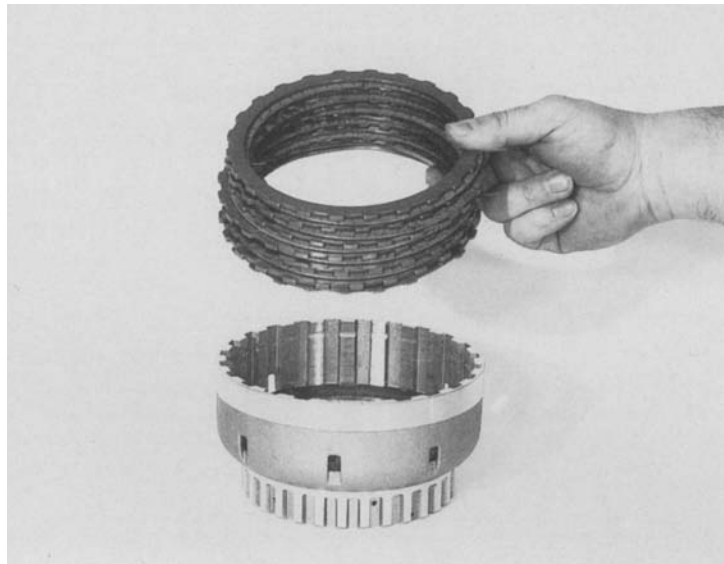

Using assembly device 5 X 46 000 576, press the diaphragm spring down in the mandrel press and remove the split ring.

91 032

Remove the diaphragm spring.

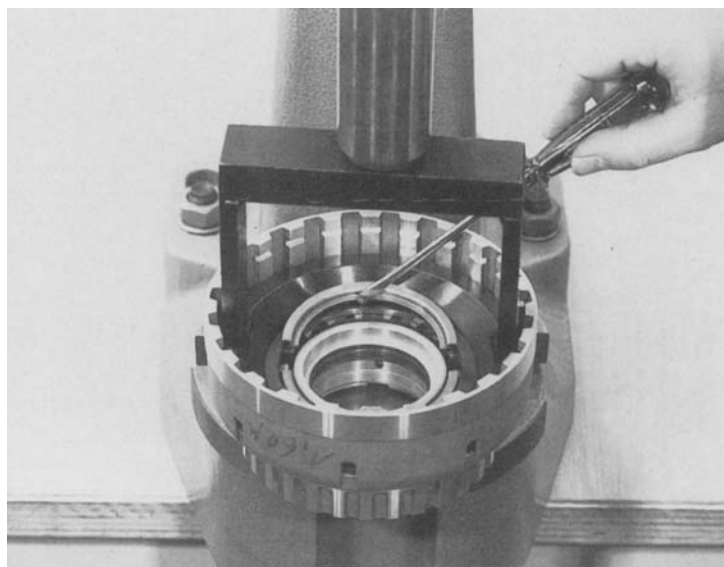

Apply a compressed air jet to one of the oil feed bores, block off two open oil feed bores with the fingertips and force out piston F by building up the necessary air pressure.

91 033

**Warning:**

Set the piston down in such a way that the sealing lip is not damaged or folded over.

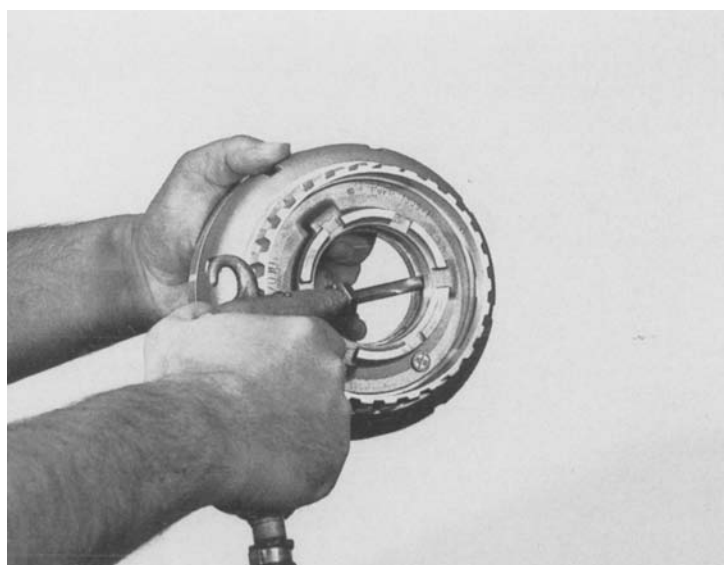

**2.3.3 Brake DG with 1st gear freewheel**

91 034

Engage the three cylindrical alignment pins of counter-holder 5 X 46 000 577 in the freewheel of the carrier.  
Turn the complete unit round.



91 035

Take out the snap ring and remove the complete disc cluster for brake G.  
Remove the 2 rectangular-section rings.



91 036

Use the hoop of assembly fixture 5 X 46 000 576 to press down diaphragm spring G in the mandrel press, and take out the snap ring with suitable pliers.

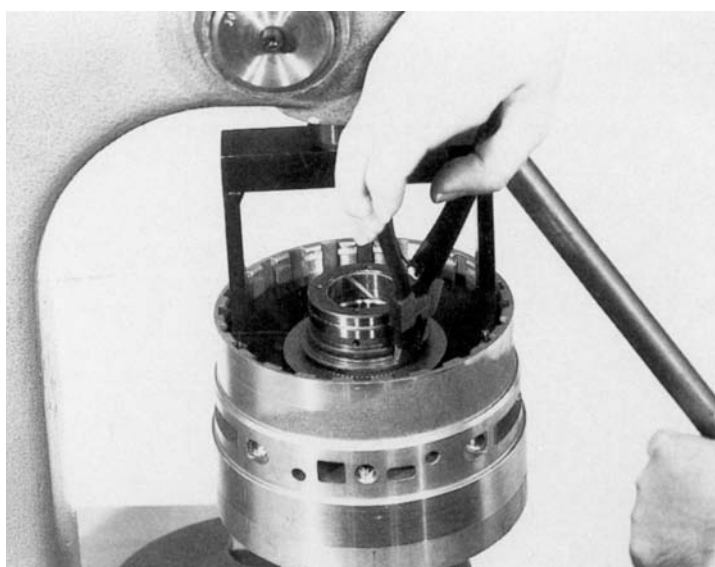

91 037

Take out the thrust washer and the diaphragm spring.

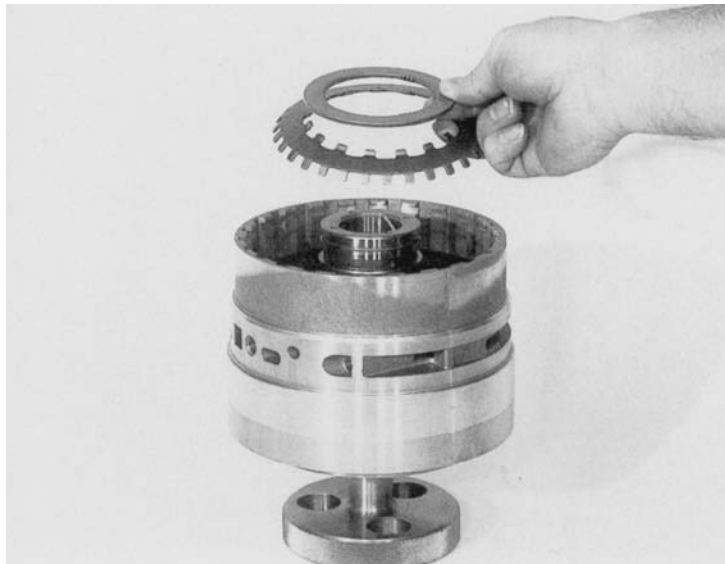

91 038

Apply a compressed air jet to the oil feed bore and press out piston G by means of the air pressure.

**Warning:**

Set the piston down so that the sealing lip is not damaged or folded over.



91 039

Lift cylinder DG away from complete carrier (freewheel).





91 040

Take out the snap ring for brake D and remove the complete disc cluster, the diaphragm spring and the retaining washer.

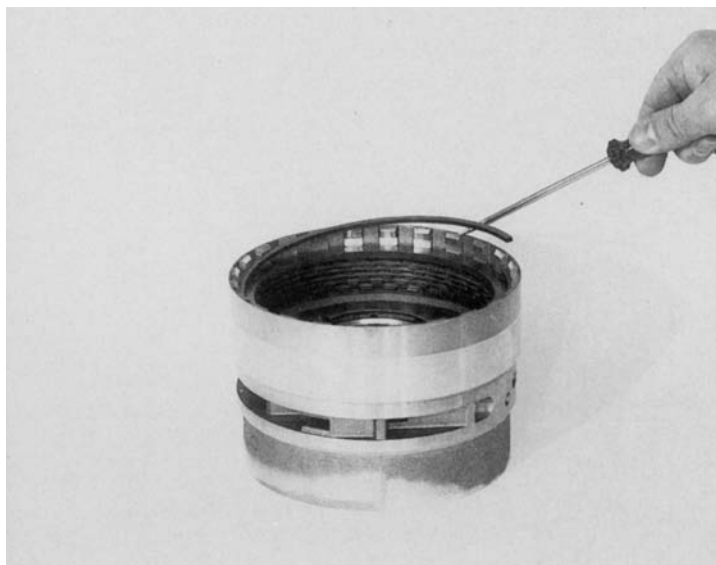

91 041

Apply a compressed air jet to the oil feed bore and force out piston D by air pressure.

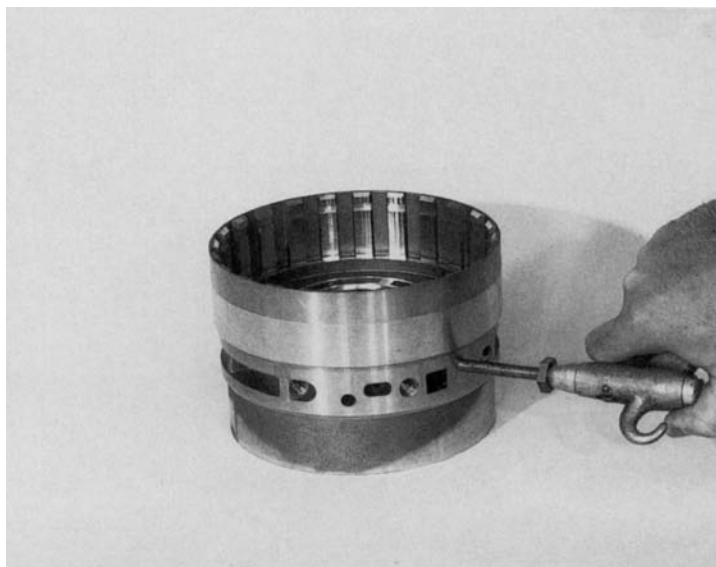

91 042

Disengage the three cylindrical pins of the counter-holder and remove it.

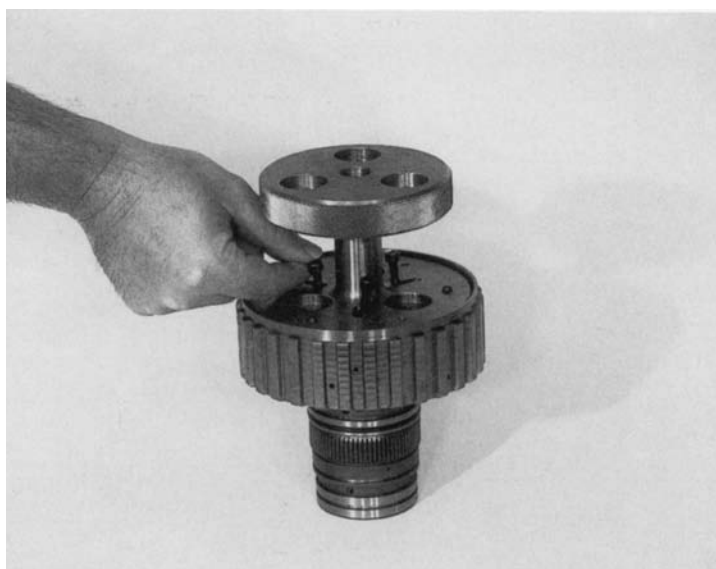

91 043

Pull both O-rings off the carrier and press out the freewheel.



91 044

**2.4 Input side**

Remove the 3rd gear freewheel.

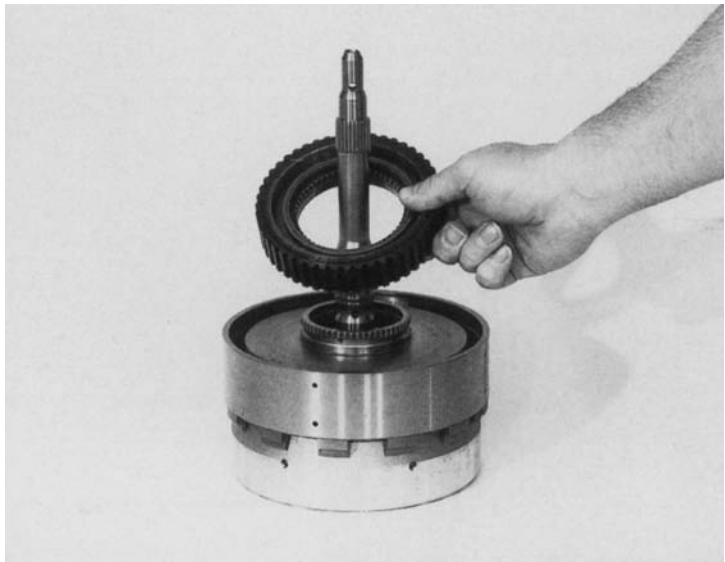

91 045

Pull clutch B away from clutch A.

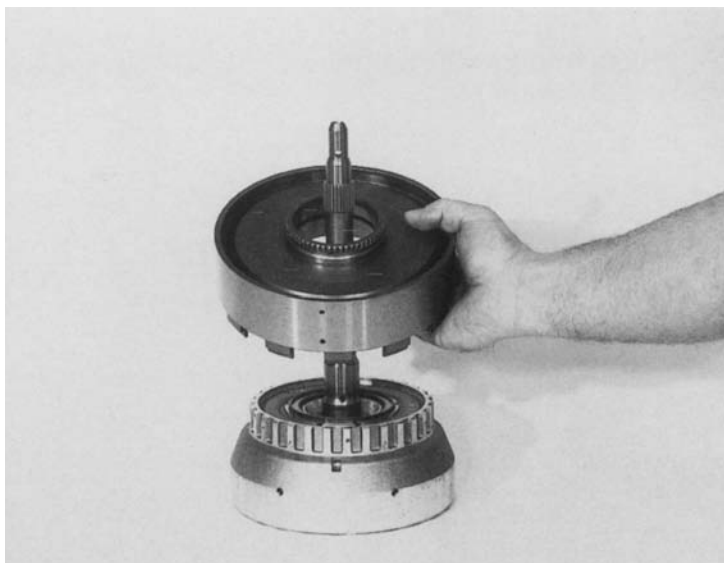

91 046

Remove 2 angled discs and one needle roller thrust bearing. Clutch A can then be separated from clutch E.

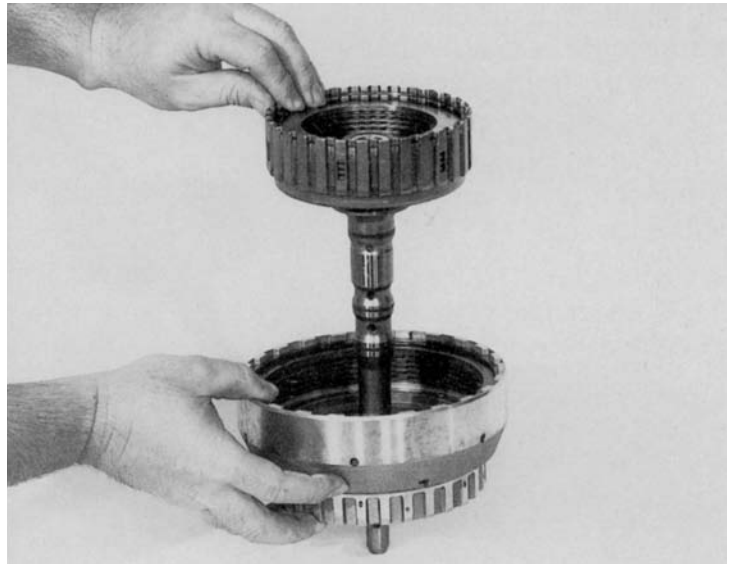

91 047

### 2.4.1 Clutch E

Take out the snap ring and remove the complete clutch E disc cluster.

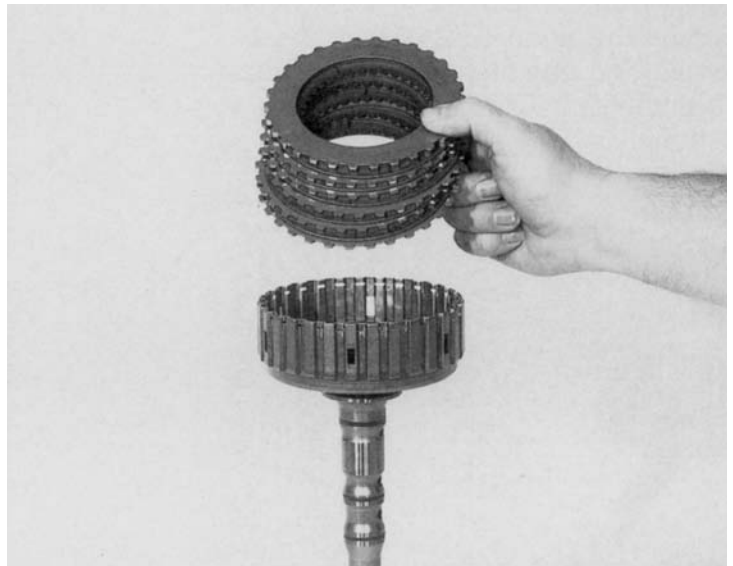

84 097

Use assembly fixture 5 X 46 000 863 to press diaphragm spring E down completely in the mandrel press. Take out the split retaining ring and remove the diaphragm spring.

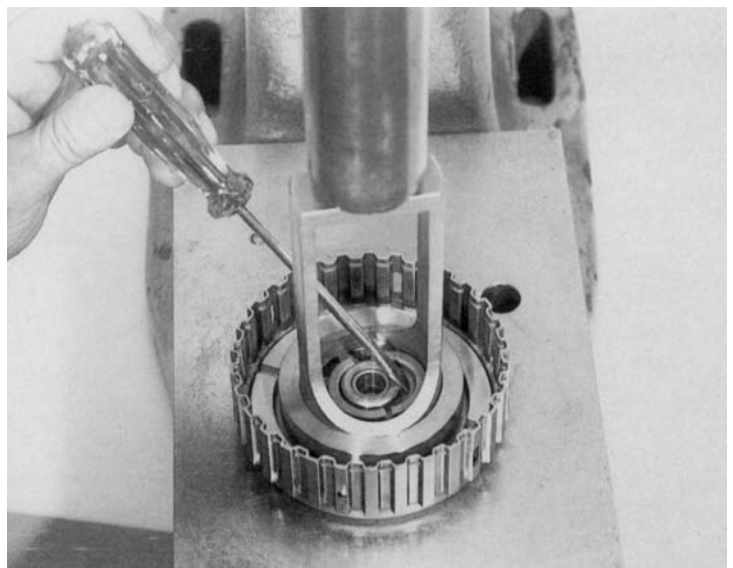

91 048

Use compressed air to force out piston E, by applying a compressed air jet to the oil feed bore.

Remove the O-ring; the rectangular-section rings normally remain on the input shaft.

**Note:**

The plastic rings have chamfered butt ends.

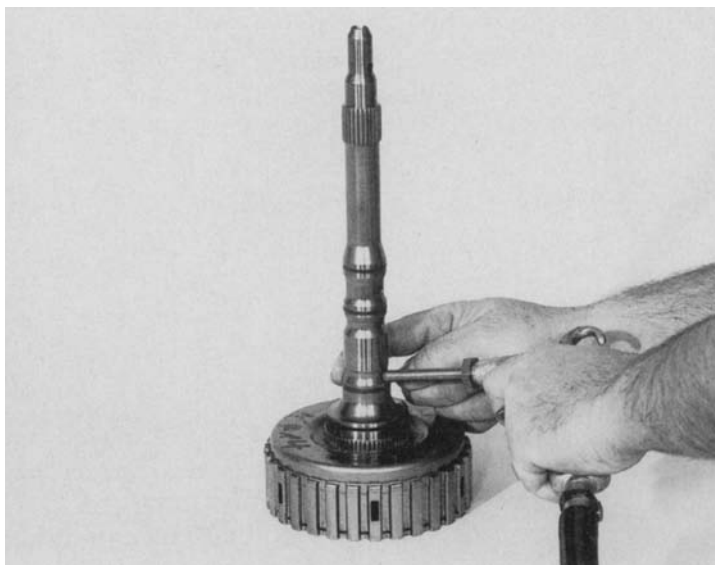

85 143

**2.4.2 Clutch A**

Remove the snap ring from cylinder A and take out the complete disc cluster including the spring disc.

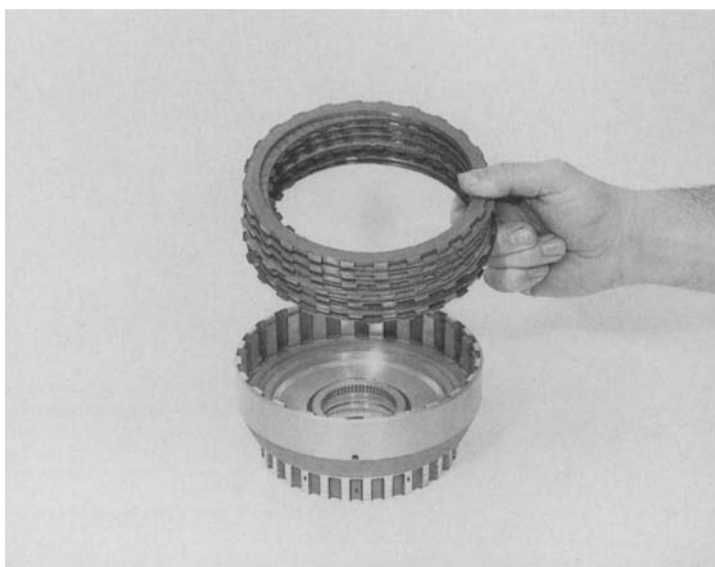

84 092

Using the hoop from special tool 5 X 46 000 167, press down the retaining disc in the mandrel press and lever out the snap ring with suitable pliers and with the aid of a screwdriver.

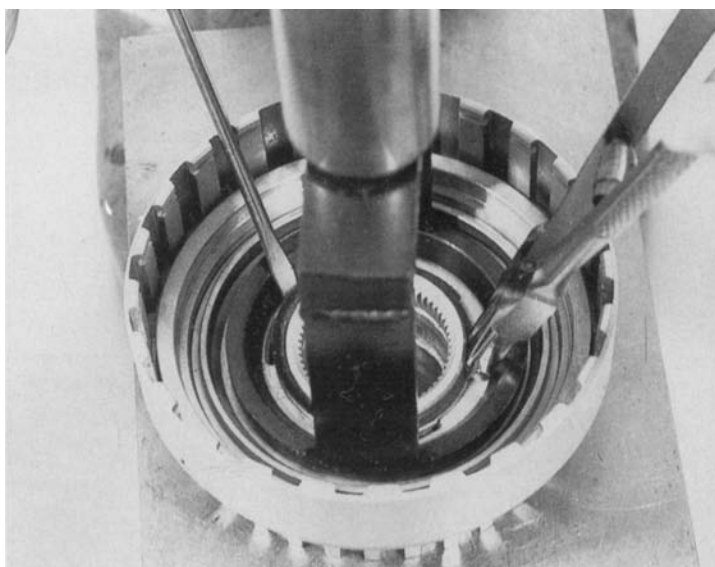

84 093

Apply a compressed air jet to one of the oil feed bores, block off two open oil feed bores with the fingertips and force out piston A by building up the necessary air pressure.

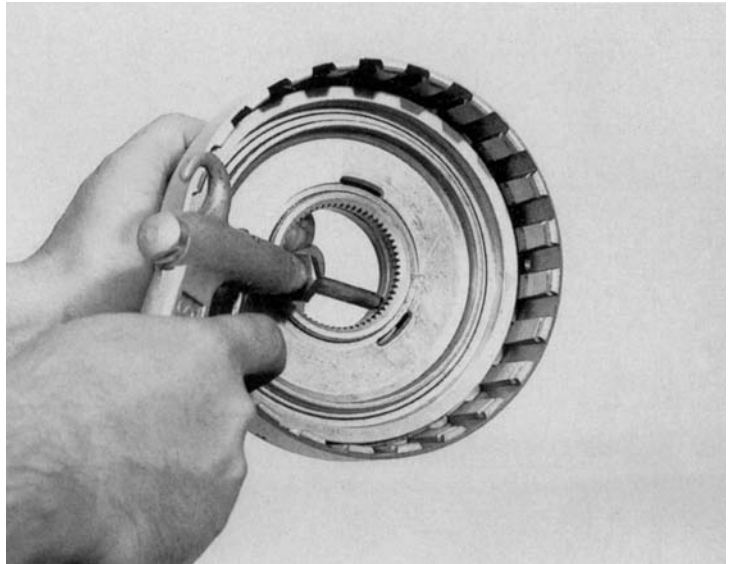

84 094

Remove the retaining disc and the diaphragm spring beneath it by striking lightly on the workbench.

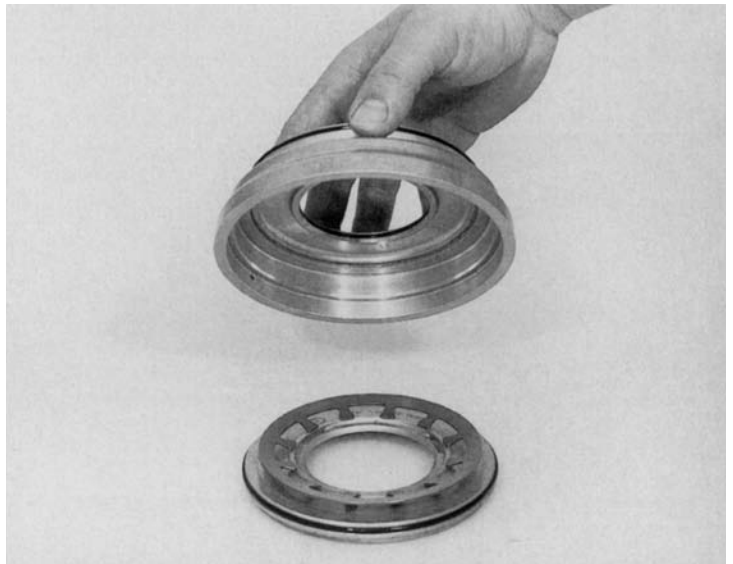

91 049

**2.4.3 Clutch B and 3rd gear freewheel**

Take out the clutch B snap ring and remove the complete disc cluster.

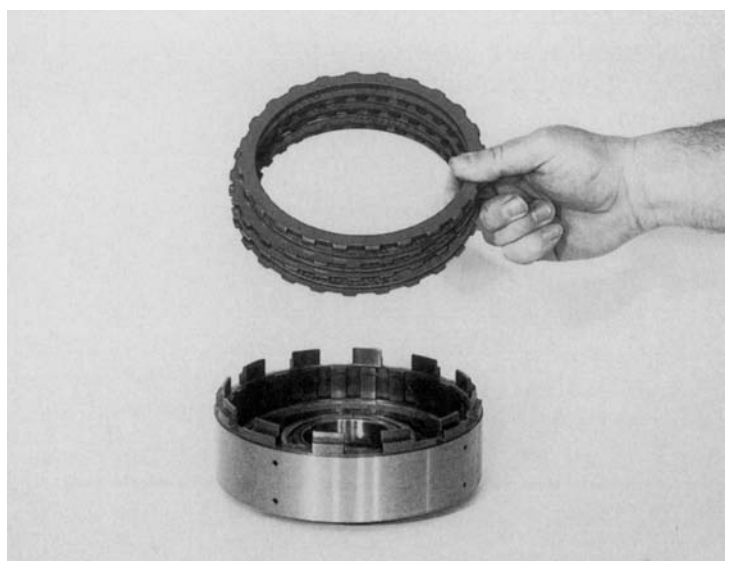

91 050

Using special tool 5 X 46 000 221, press the diaphragm spring down in the mandrel press and take out the split retaining ring.

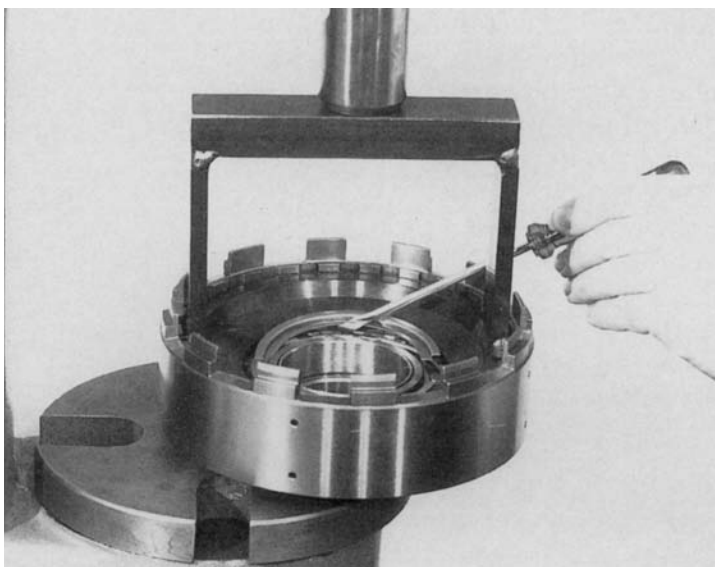

85 136

Take out the diaphragm spring.

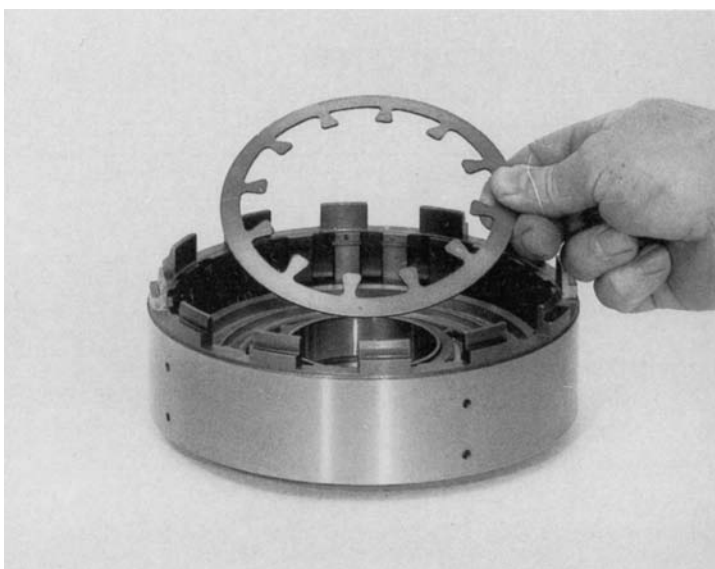

85 137

Apply a compressed air jet to the oil feed bore and force out piston B by building up the air pressure.



85 138

Press the intermediate ring out of the piston.

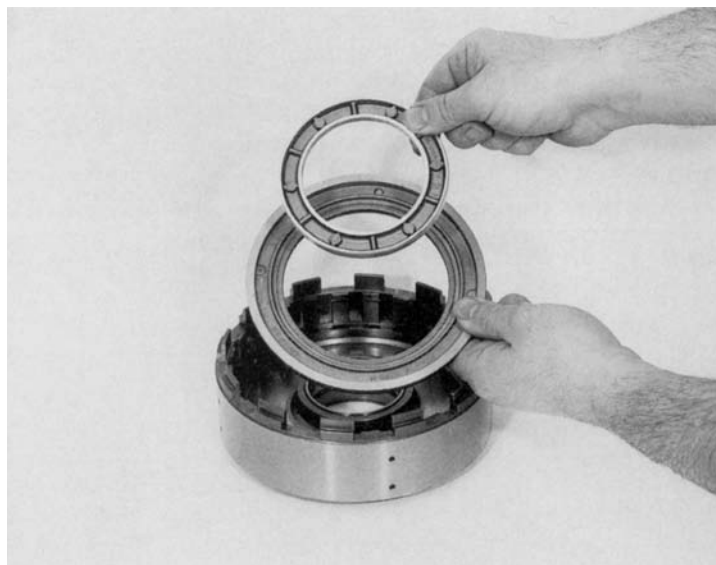

91 051

The 3rd gear freewheel can be stripped down for cleaning purposes. First press the inner race of the freewheel out of the cage.



91 052

Separate the two cover discs from the outer race together with the freewheel cage.

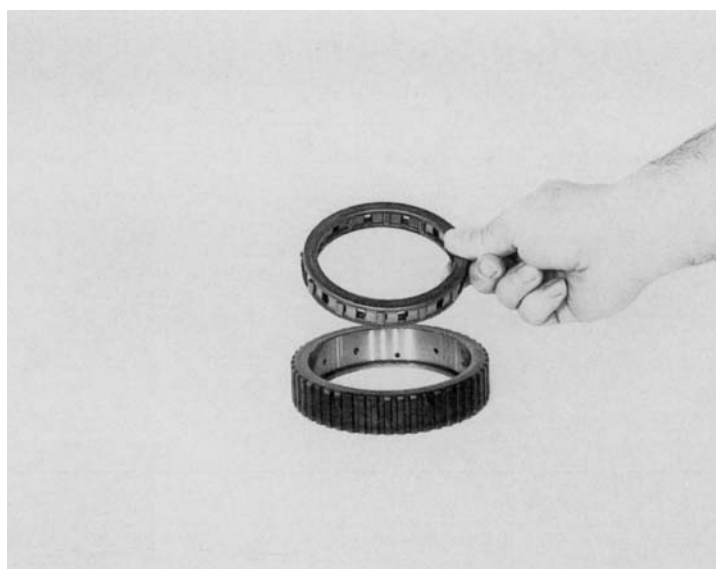

#### 2.4.4 Brake C<sup>2</sup>

91 053

Take out the 3 screw plugs. Bolt on assembly fixture 5 X 46 000 574. Press the brake band control cover down and take out the snap ring, using a suitable screwdriver.

(Allen key size = 5 mm)



Take out the cover, shim washer and complete piston.

Remove the pin of the brake band fastener from the housing.

91 054

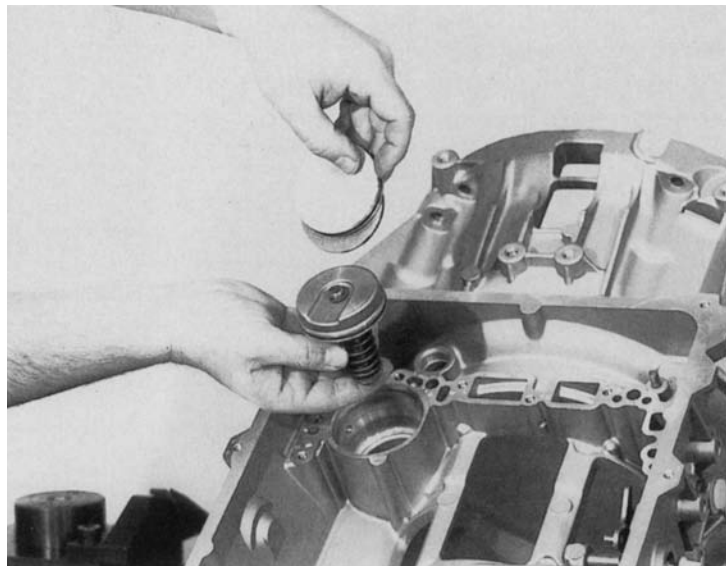

The complete piston can be stripped down for cleaning after the lock washer has been pulled off.

91 055

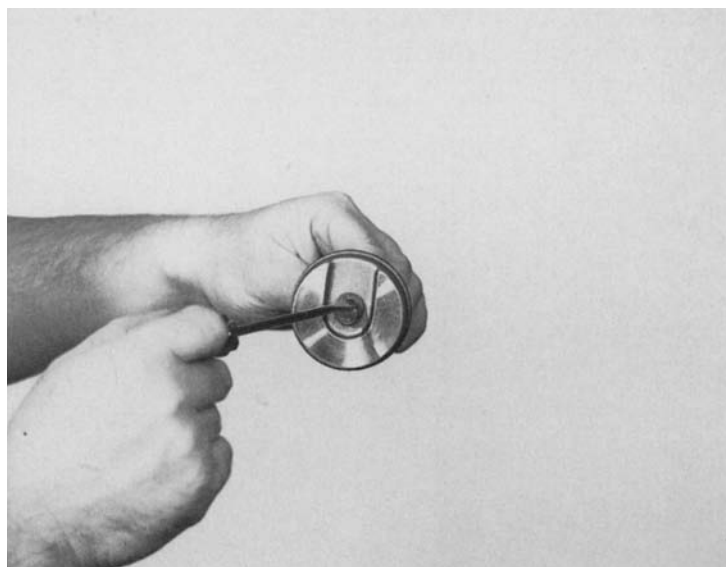



### 2.5 Oil supply unit with brake C<sup>1</sup>

91 056

Remove the snap ring from the groove and take out the complete set of discs for brake C with the diaphragm spring.

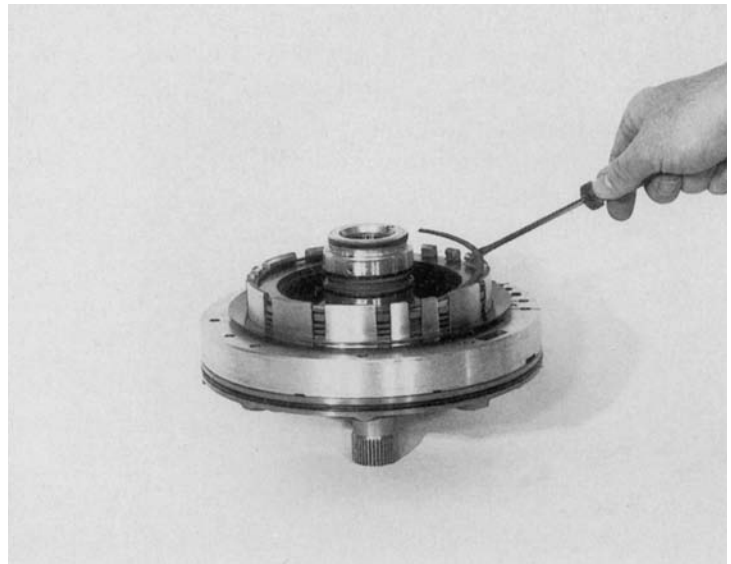

Force out piston C with a compressed air jet applied to the oil feed bore.

91 057

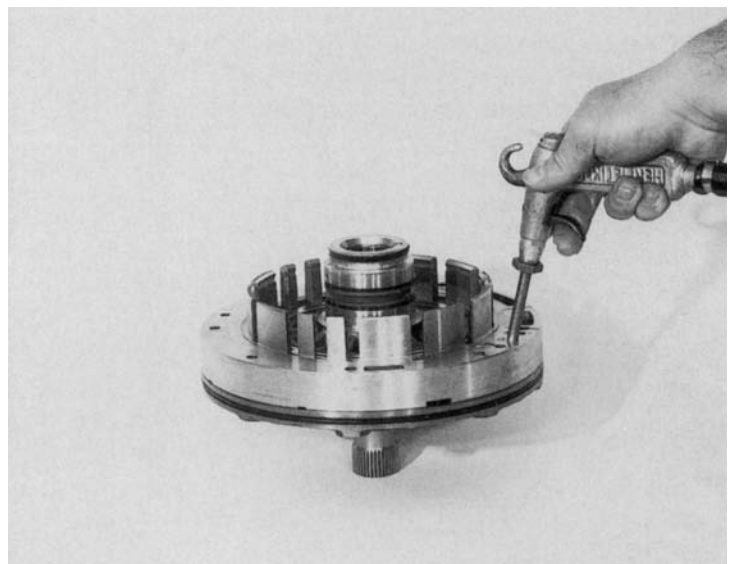

Take out the 7 machine screws under the piston and also the two additional machine screws. Separate the pump from the intermediate plate. (Wrench size = Torx TX 30)

91 058

**Note:**

The rectangular-section rings and the locating pin normally remain on the intermediate plate.

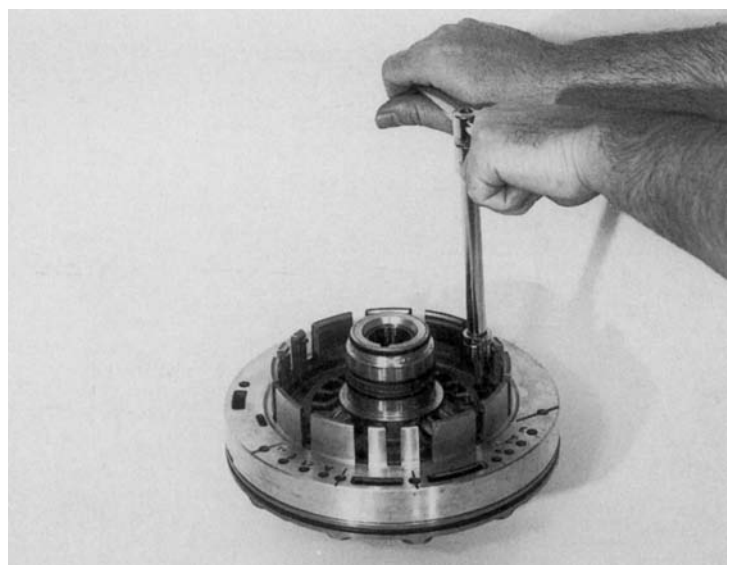

91 059

Pull off the O-ring. The pump can be stripped down by taking out the pump gear and pump hollow gear.

Lever out the shaft sealing ring with a suitable screwdriver blade; there is a corrugated washer under this ring.

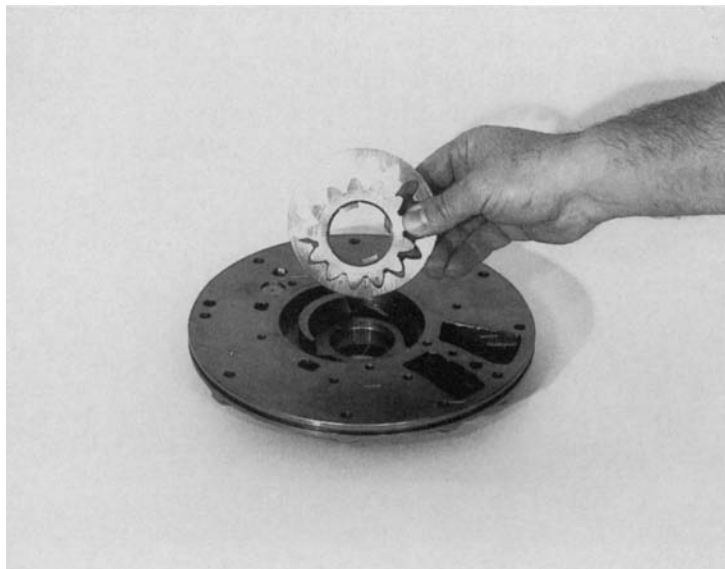

91 060

**2.6 Housing with shift and parking interlock**

Using a suitable mandrel, drive the clamping sleeve out of the detent disc and pull out the selector shaft.

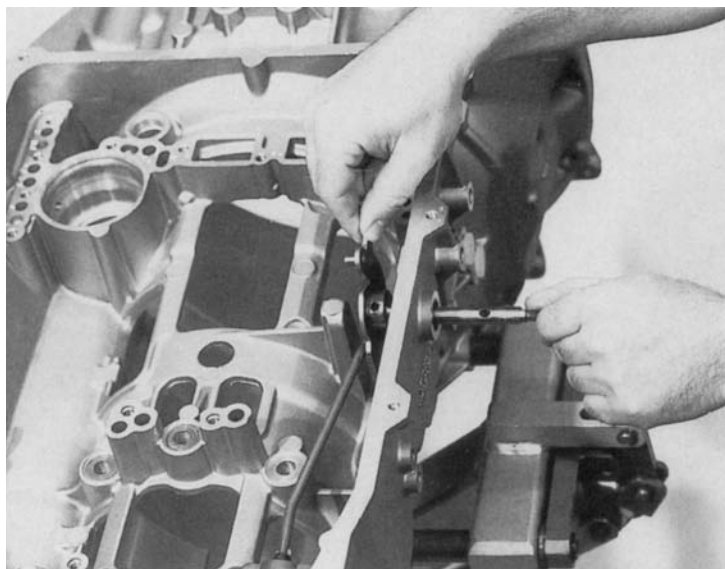

91 061

The detent disc with connecting rod can now be removed. Lever out the shaft sealing ring with a screwdriver.

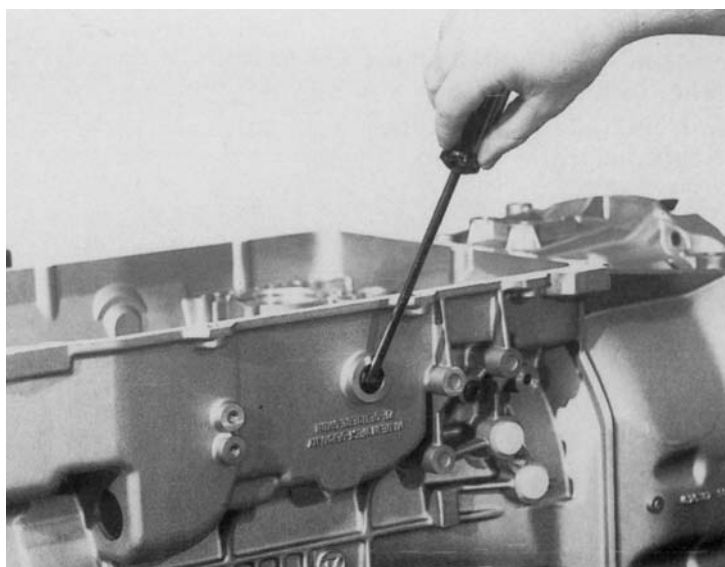

91 062

The detent spring normally remains in the transmission housing. If it is to be taken out, slacken off the two machine screws.

**Warning:**

Older versions have a loose locating pin.

(Wrench size = Torx TX 27)

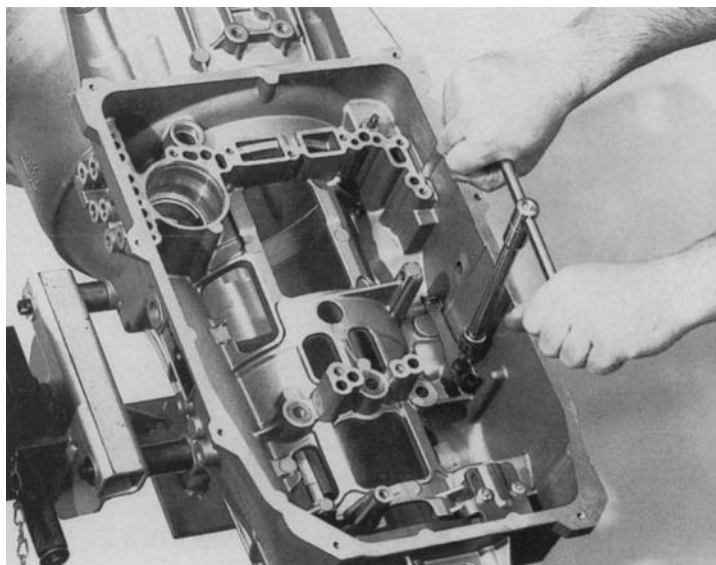

91 063

Take out the four machine screws and remove the guide plate.

(Wrench size = Torx TX 27)

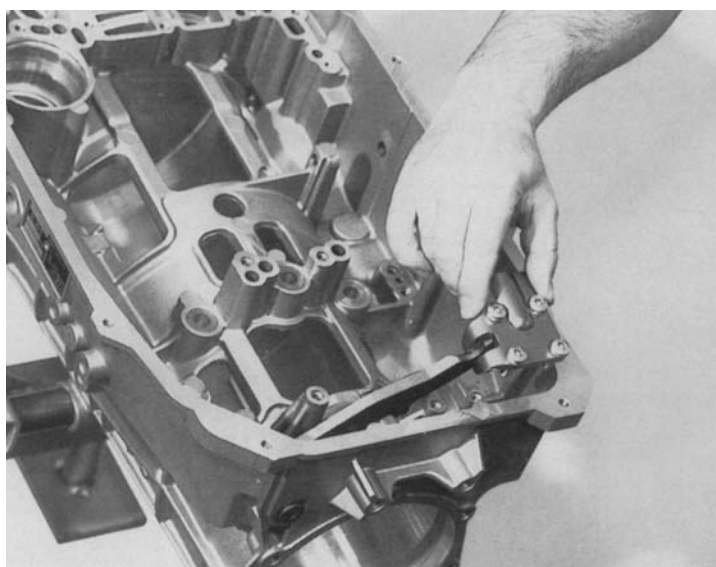

91 064

Remove the screw plug with its sealing ring and press the pin out of the housing from the inside.

(Allen key size = 6 mm)

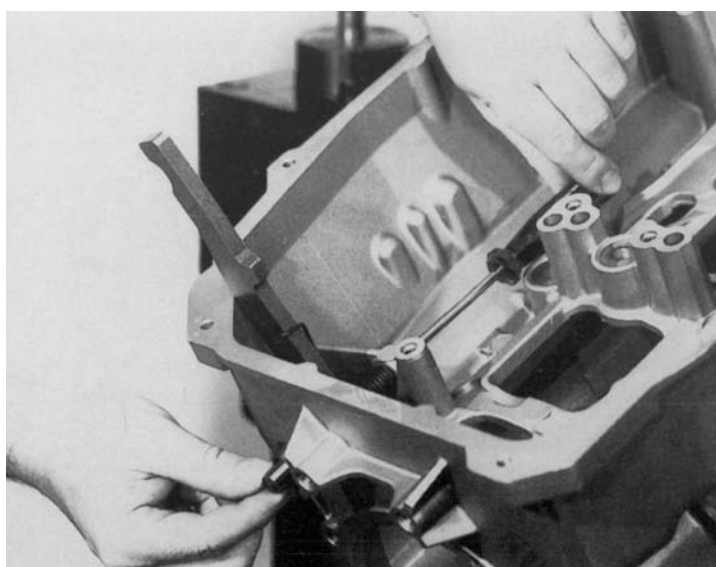

91 065

The pawl and its torsion spring can now be removed.

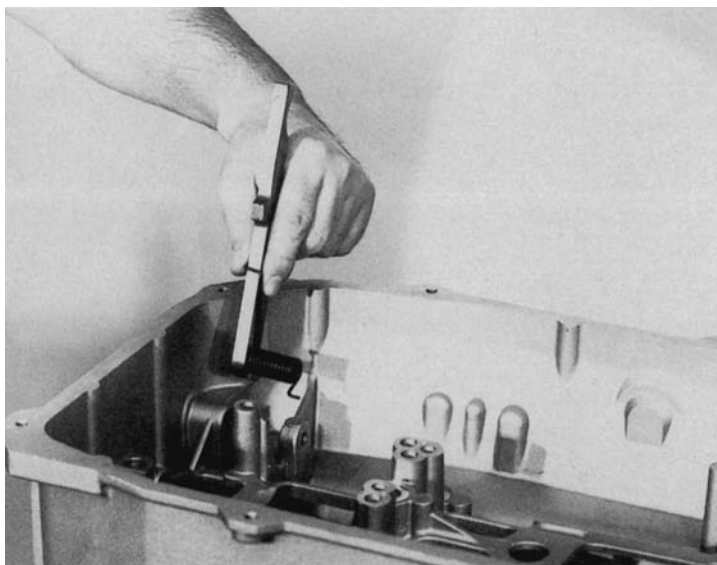

91 066

When cleaning the transmission housing you are recommended to take out all the screw plugs.

(Allen key size = 5 mm)

The straight pin and the breather can remain in the housing.

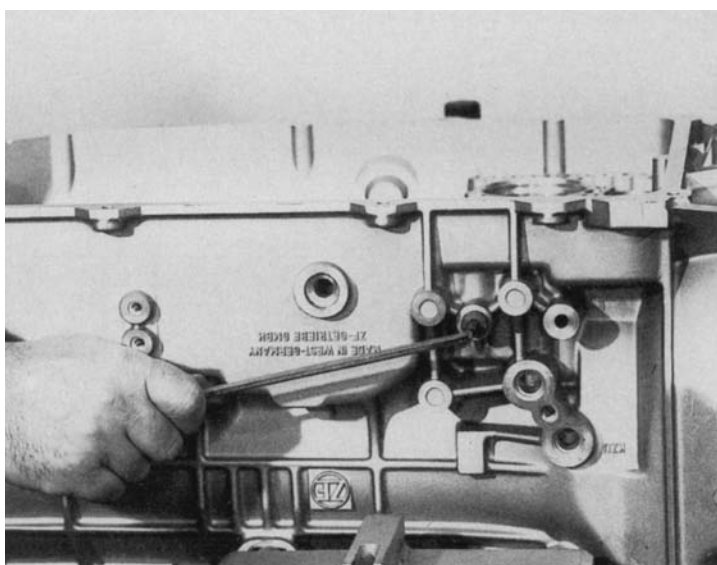

### 3. Assembling

#### 3.1 Transmission housing with shift and parking pawl

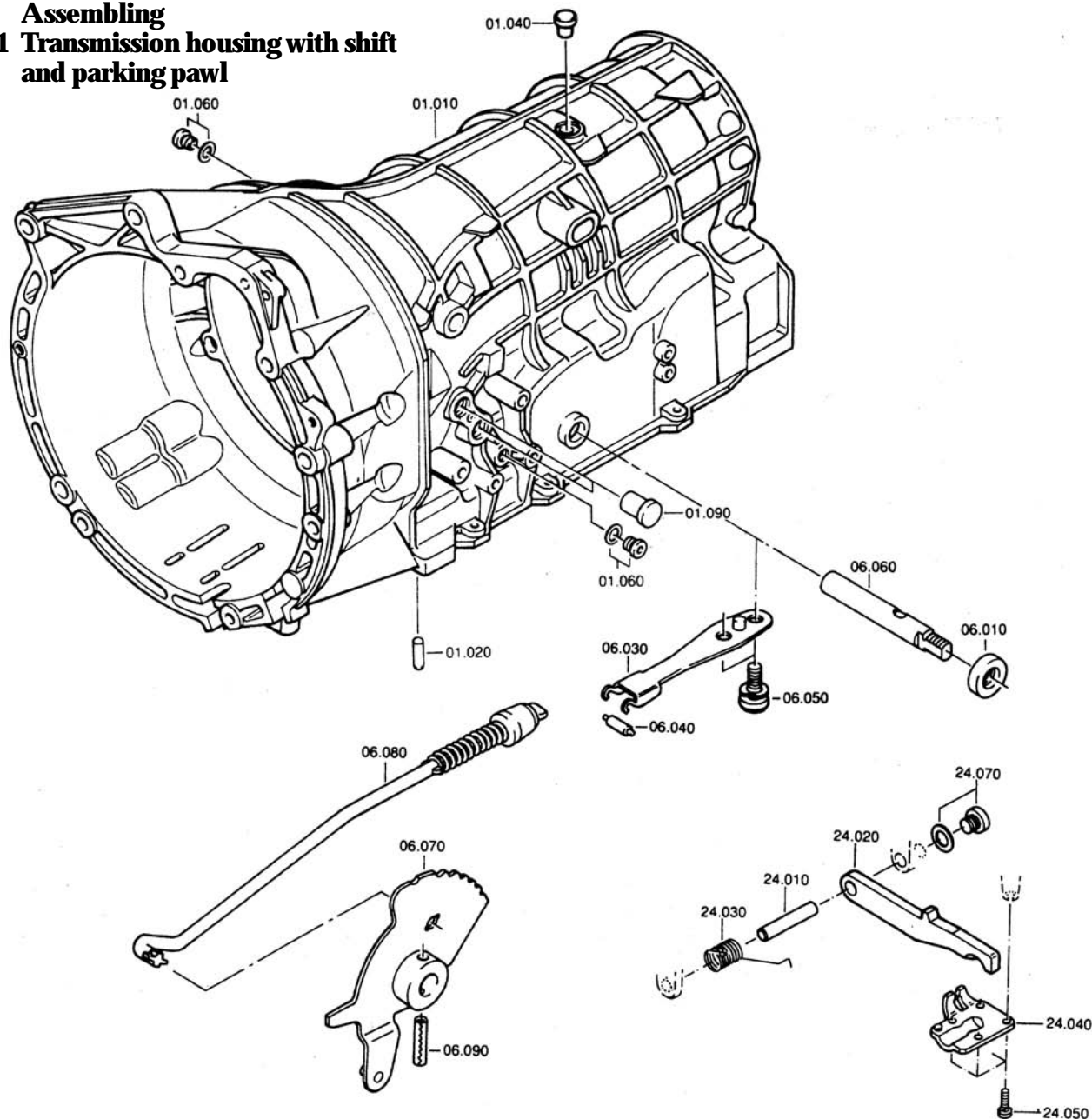

91 067

Insert two of the 5 screw plugs 01.060, M 10 x 1, with new O-rings into transmission housing 01.010 on each side. Leave the holes designated C<sup>2</sup>, PM and PH in the transmission housing open for later assembly stages. (Allen key size = 5 mm) (Tightening torque = 15 Nm)

Install straight pin 01.020 and breather 01.040, and the two plastic plugs 01.090.

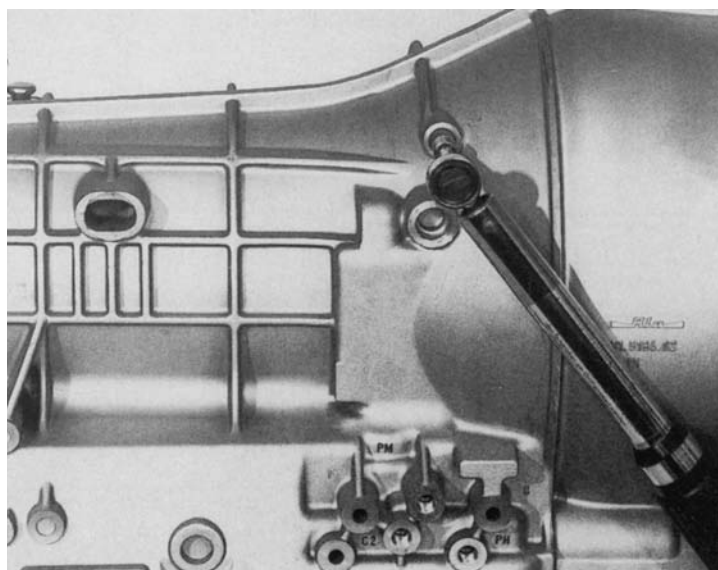

91 068

Using pressing-in tool 5 X 46 000 737, drive a new shaft sealing ring 06.010 into the transmission housing.

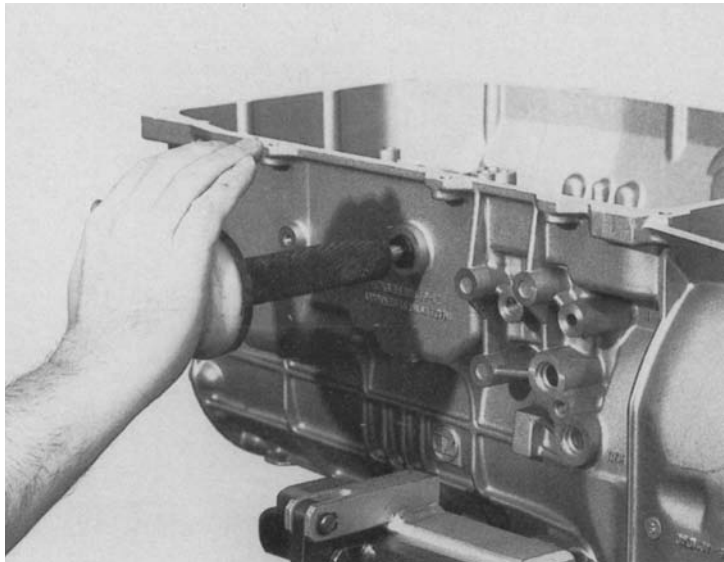

91 069

Using a plastic-headed hammer, drive roller 06.040 into detent spring 06.030.

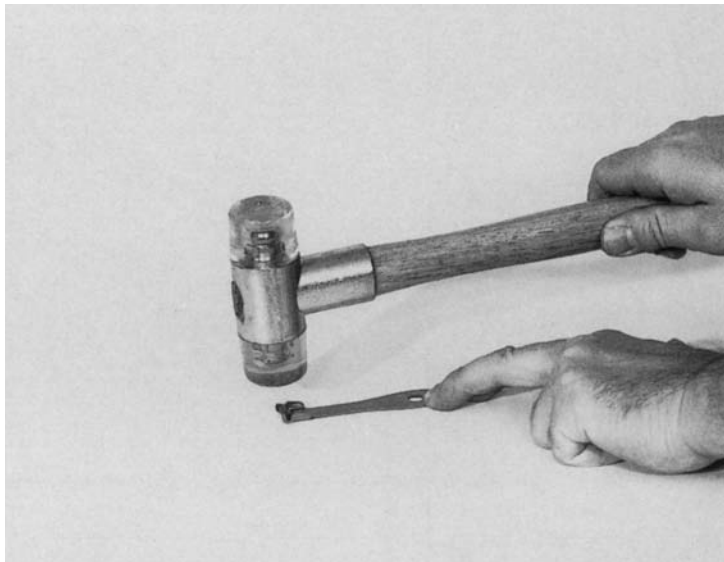

91 070

Secure the detent spring with 2 machine screws 06.050 in a position in which the spring does not scrape on the transmission housing. Older versions: the locating pin must be installed separately.  
(Wrench size = Torx insert TX 27)  
(Tightening torque = 10 Nm)

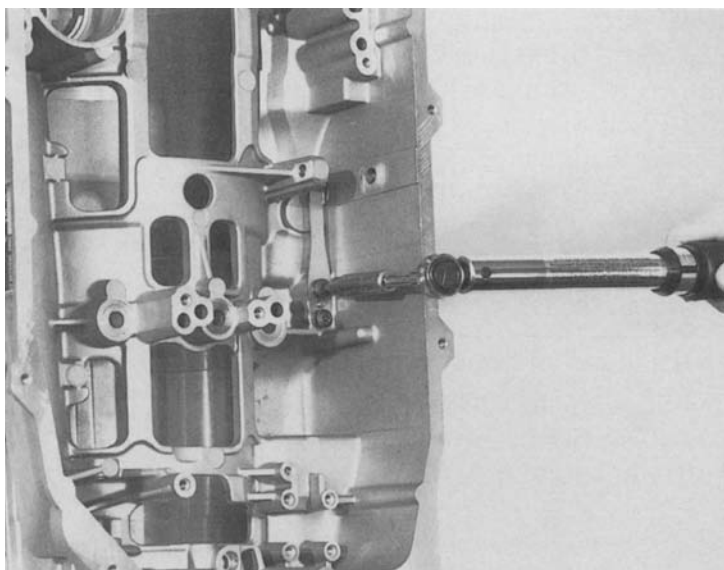

91 071

Attach connecting rod 06.080 to detent disc 06.070, and turn to secure.

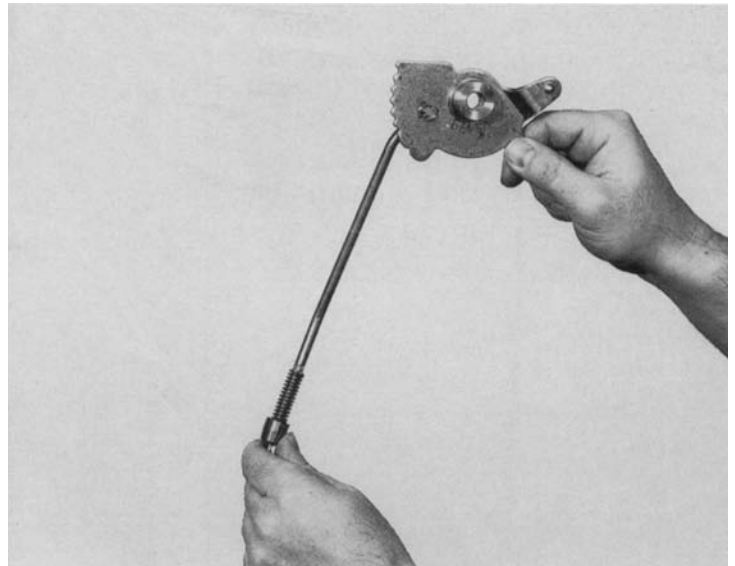

91 072

Insert detent disc with connecting rod into transmission housing and push in selector shaft 06.060.

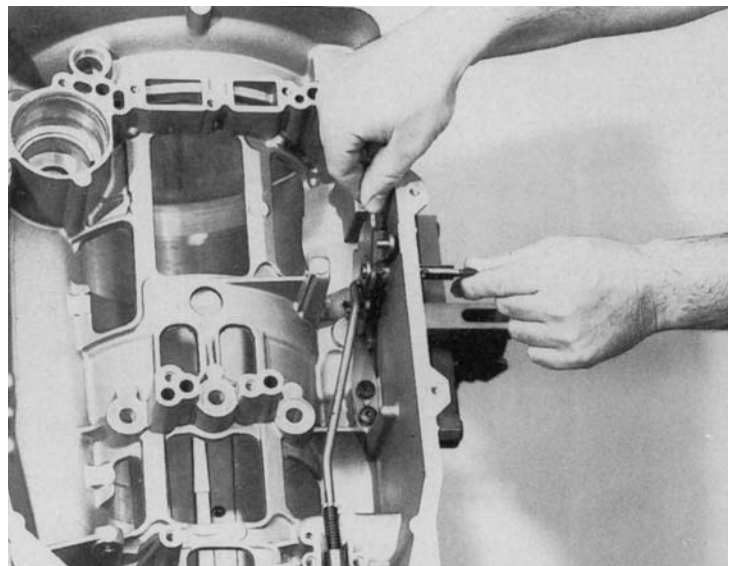

91 073

Using special tool 5 X 46 000 685 or a suitable punch, drive a new locking pin 06.090 into a position in which the open side of the locking pin faces towards the output side.

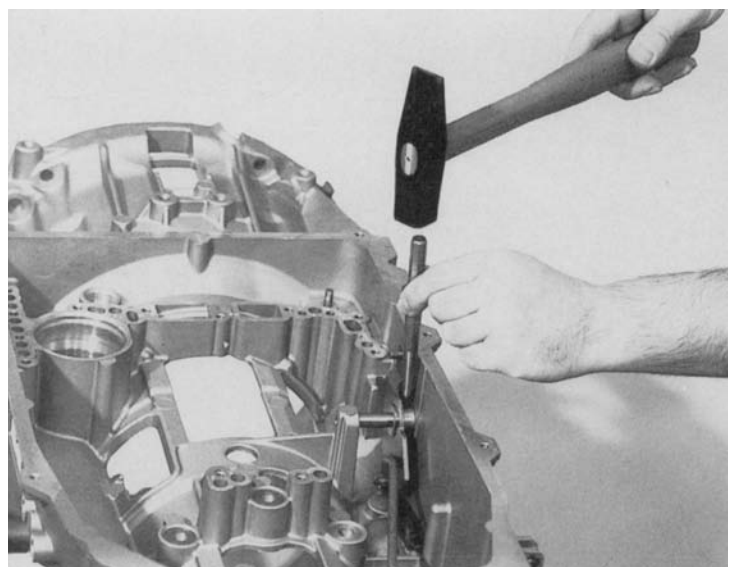

91 074

Place pawl 24.020 with torsion spring 24.030 in the transmission housing and secure it by pressing in pin 24.010. After this, seal the hole with screw plug 24.070, with a new sealing ring.

(Allen key size = 6 mm)

(Tightening torque = 32 Nm)

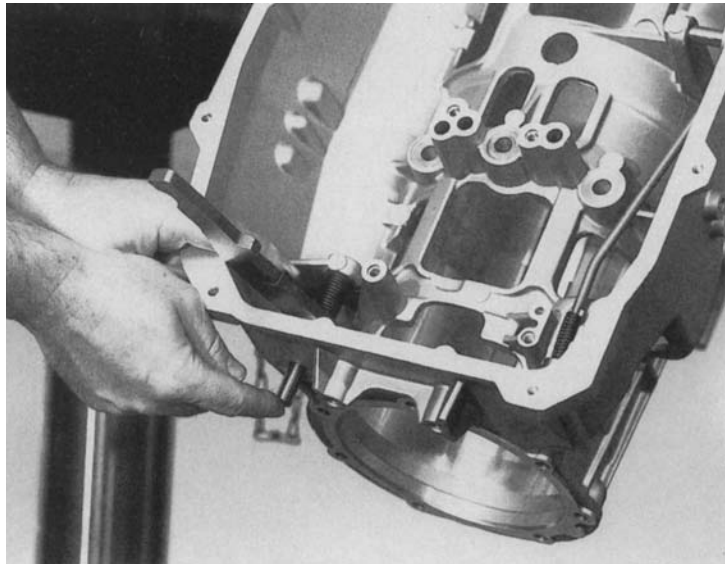

91 075

Press down the pawl. The connecting rod must be pressed to the rear by turning the detent disc. Secure guide plate 24.040 with 4 machine screws 24.050.

(Wrench size = Torx TX 27)

(Tightening torque = 10 Nm)

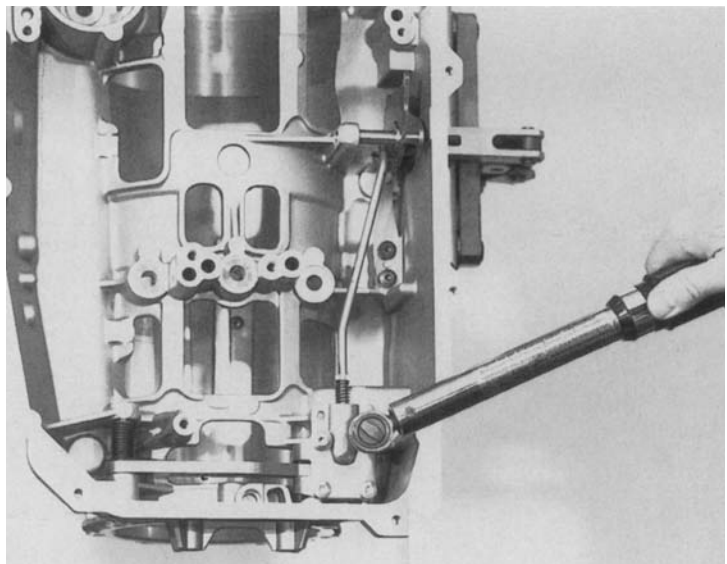



### 3.2 Planetary gear set, complete

#### 3.2.1 Planetary gear set III

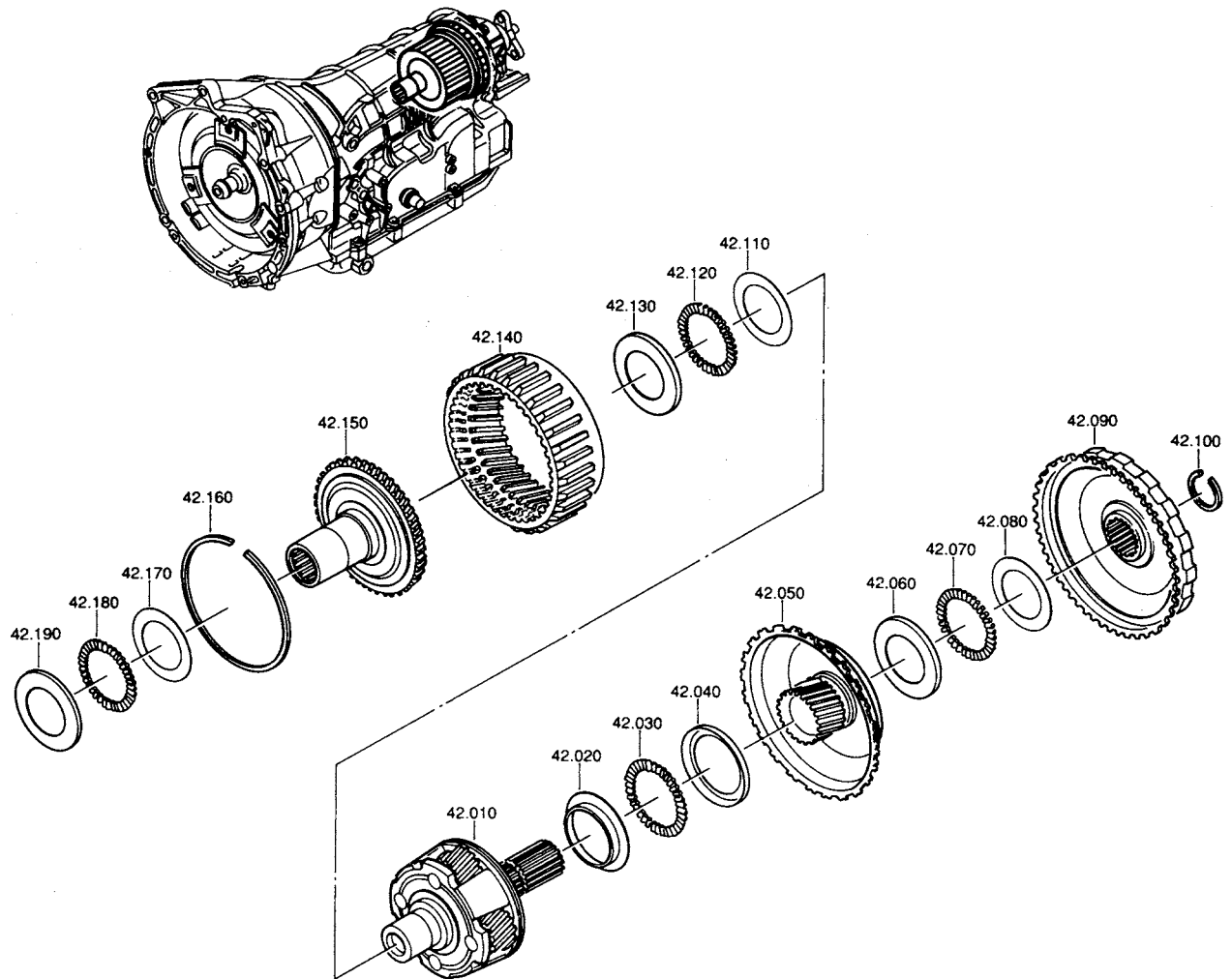

91 076

Place thrust washer 42.080, needle roller thrust bearing 42.070 and angled disc 42.060 in parking interlock gear 42.090.

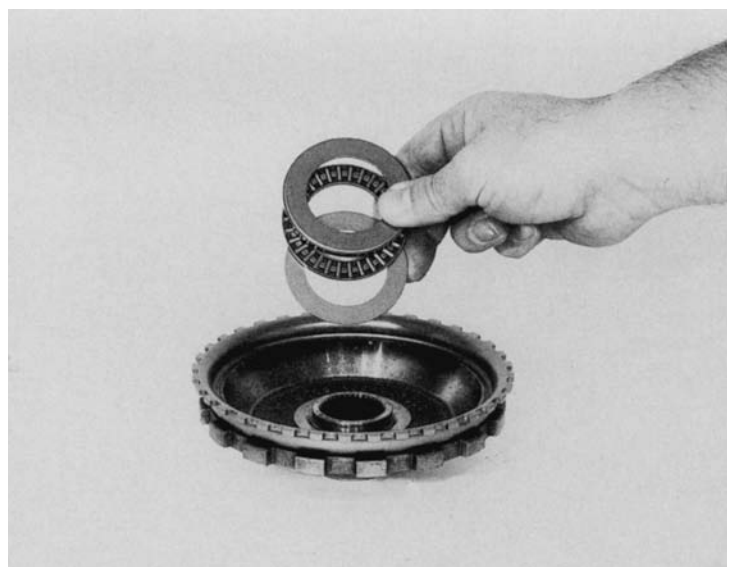

91 077

Install the sun wheel 42.050 and place angled disc 42.040, needle roller thrust bearing 42.030 and angled disc 42.020 over the sun wheel hub.

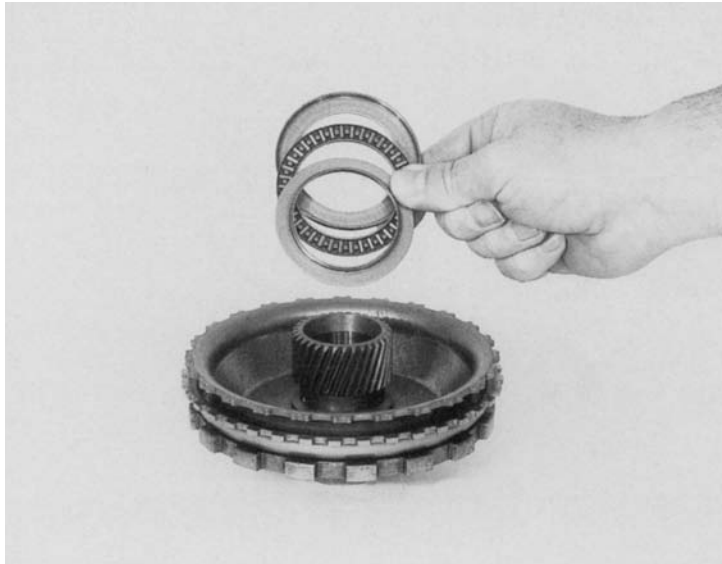

91 078

Planet carrier 42.010 can now be installed, and secured with snap ring 42.100. Make sure that the thrust bearings remain centered. Place the complete unit on mounting 5 X 56 000 072.

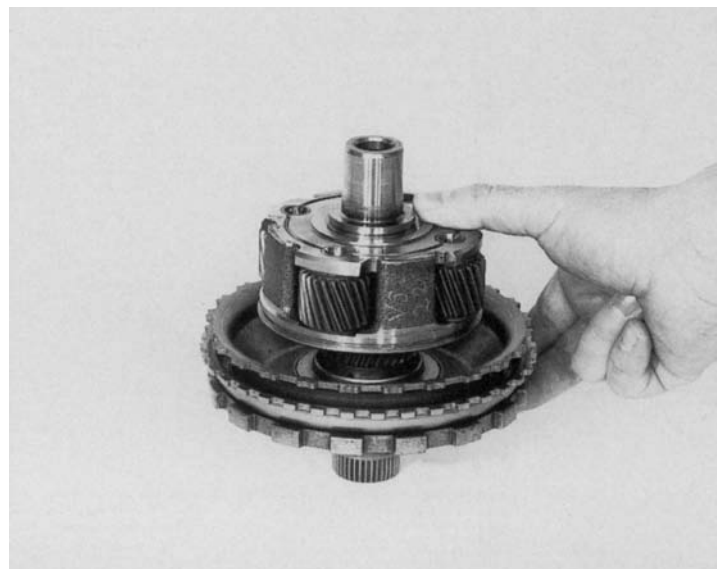

91 079

Place hollow gear carrier 42.150 in hollow gear 42.140 and secure with snap ring 42.160. Place thrust washer 42.170, needle roller thrust bearing 42.180 and angled disc 42.190 on hollow gear unit.

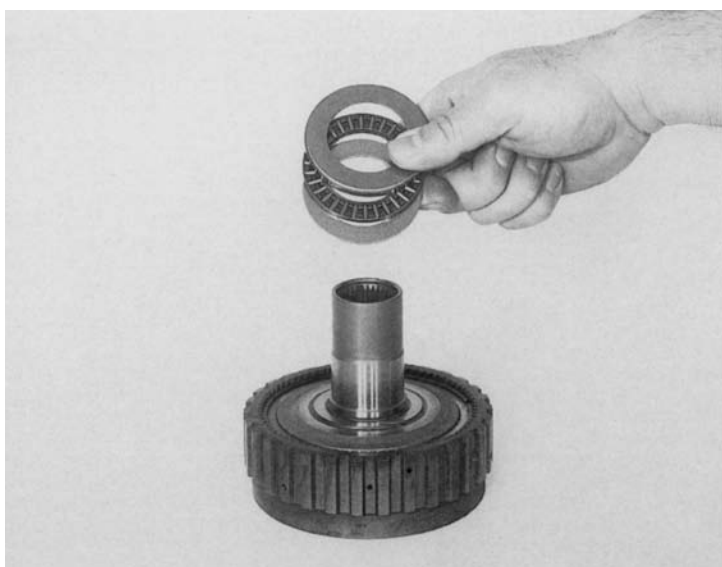

Place thrust washer 42.110, needle roller thrust bearing 42.120 and angled disc 42.130 on the planet carrier and install the complete hollow gear unit on it.

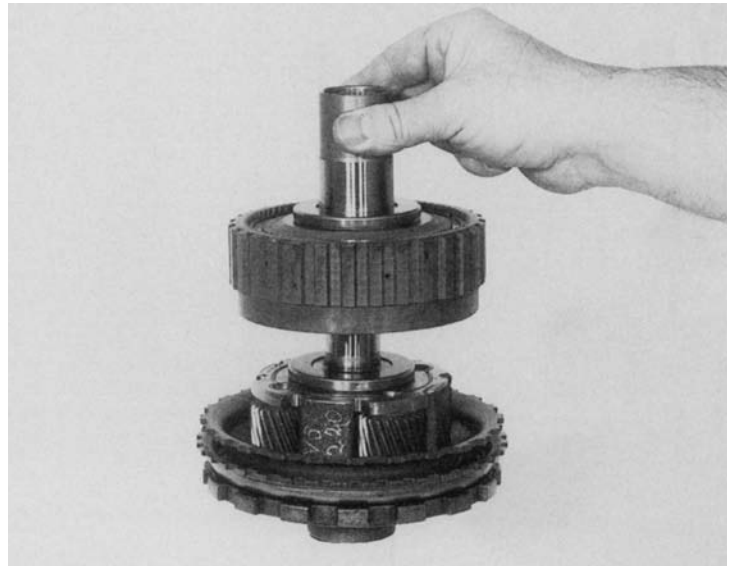

### 3.2.2 Clutch F

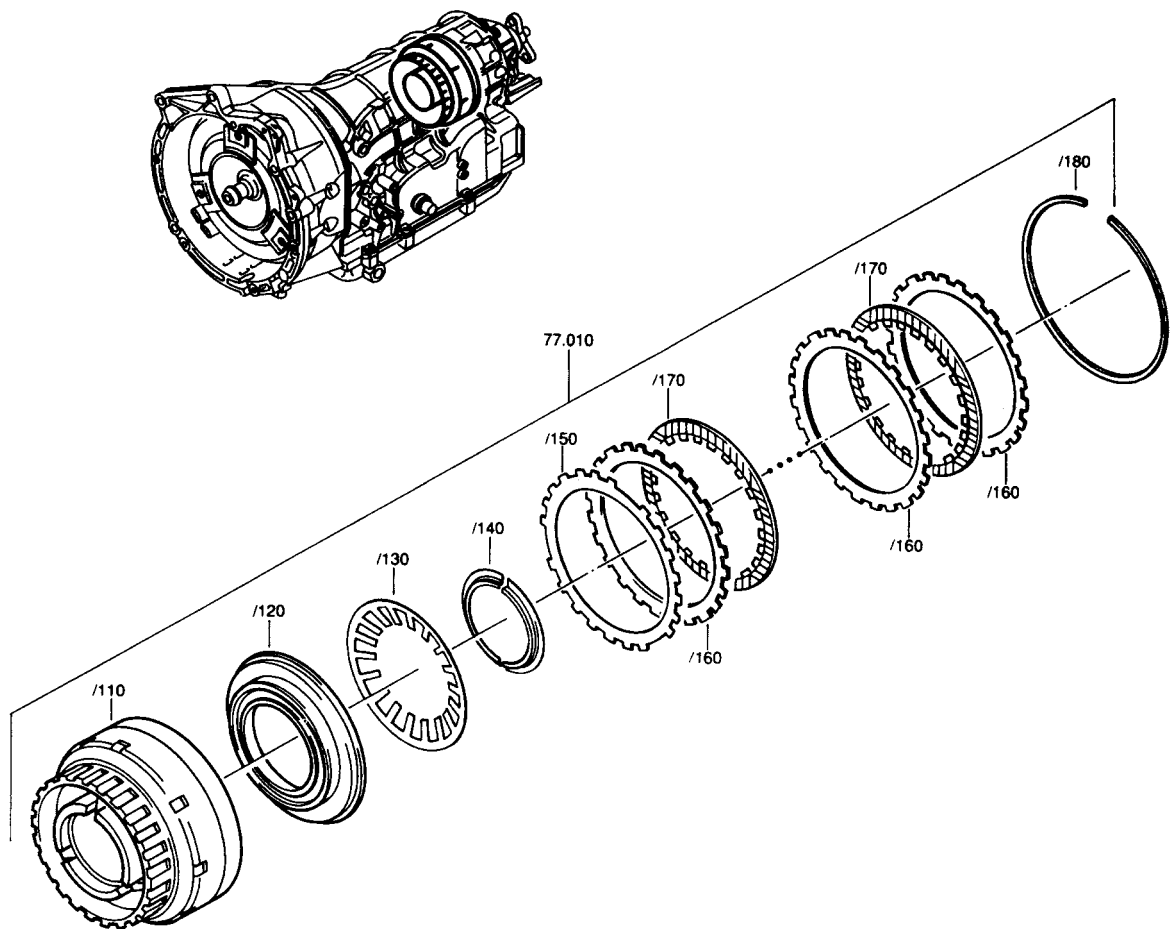

91 081

Apply a light coat of grease (Vaseline) to the inside and outside of the sealing lips on piston F 77.010/120, and press into cylinder F 77.010/110.

**Warning:**

The piston must not be tilted or the sealing lips folded over.

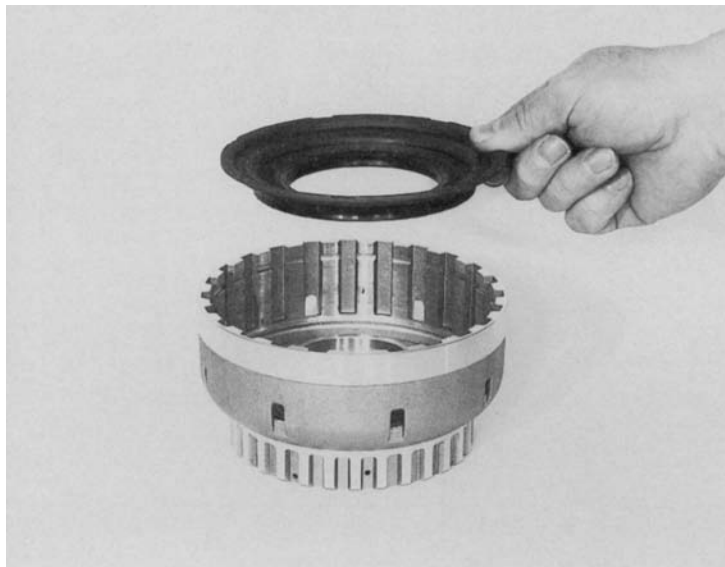

91 082

Insert diaphragm spring 77.010/130. Press it down in the mandrel press with assembly fixture 5 X 46 000 576, and the split retaining ring 77.010/140.

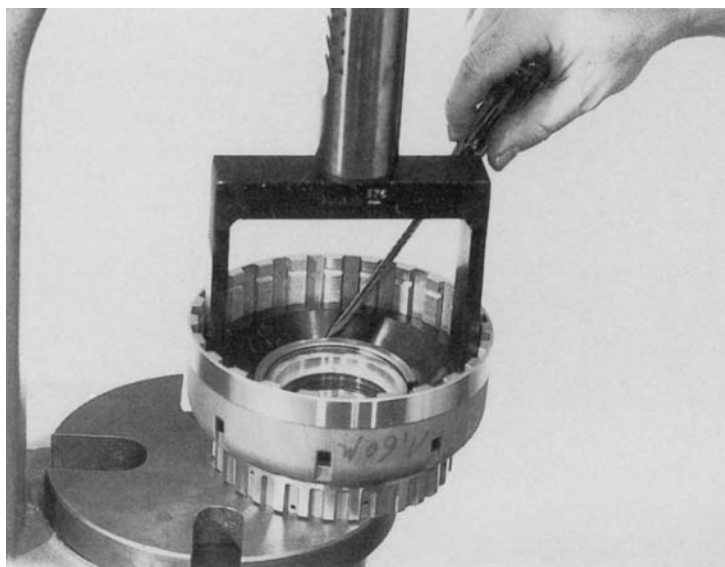

91 083

Insert the complet disc cluster, starting with spring disc 77.010/150. After this, insert steel disccs 77.010/160 and lined discs 77.010/170 alternately. Secure the upper steel disc with snap ring 77.010/180.

**Important:** carry out adjusting procedure (see item 1.4.1, Page 5/1).

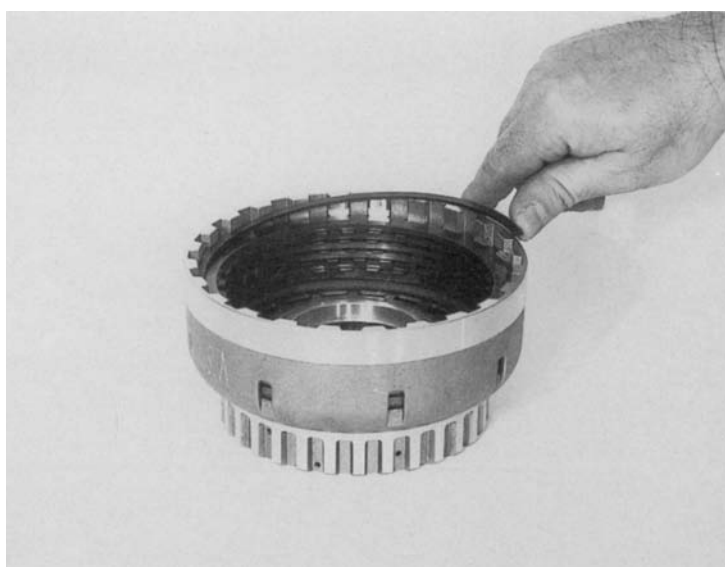

### 3.2.3 Brake DG with 1st gear freewheel

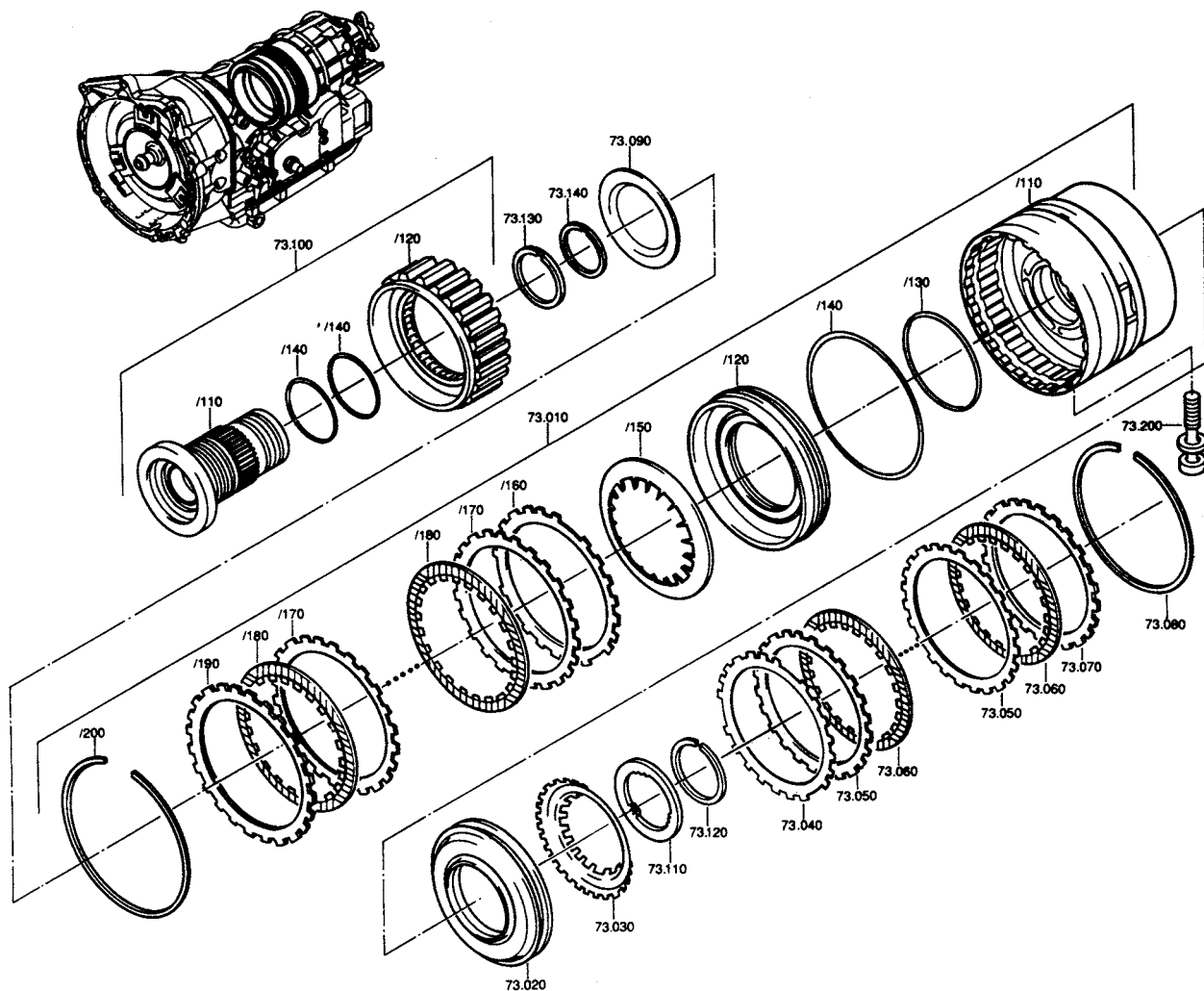

91 087

You are recommended to determine the release clearance of brakes D and G first. To do this, fit O-rings 73.010/130 and 73.010/140 to piston D (73.010/120). Grease the O-rings on piston D and the sealing lips of piston G lightly (Vaseline) and install both pistons in cylinder DG 73.010/110.

**Important:**

The pistons must make full contact, or else the readings will be incorrect. If necessary, drive them in fully with a suitable punch.

**Warning:** carry out adjustment procedure (see items 1.4.2 and 1.4.3, Page 5/2)

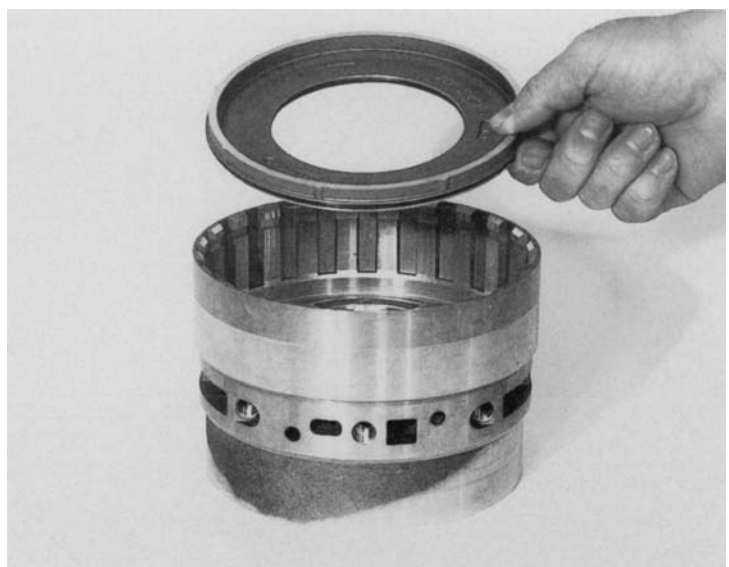

91 094

Press carrier (inner race of freewheel) 73.100/110 into freewheel 73.100. To do this, prevent the freewheel from moving and turn the carrier clockwise.



91 095

Place the complete unit on counter-holder 5 X 46 000 577 and turn until the 3 pins of the special tool engage with the freewheel. Pull on the two O-rings 73.100/140 and apply a light coat of grease (Vaseline) to them.

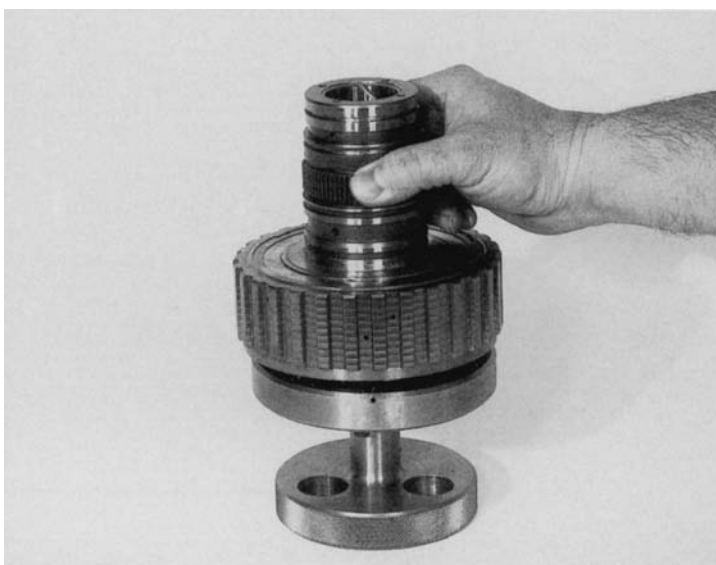

91 096

Place diaphragm spring D 73.010/150 in cylinder DG and press in retaining washer 73.090.

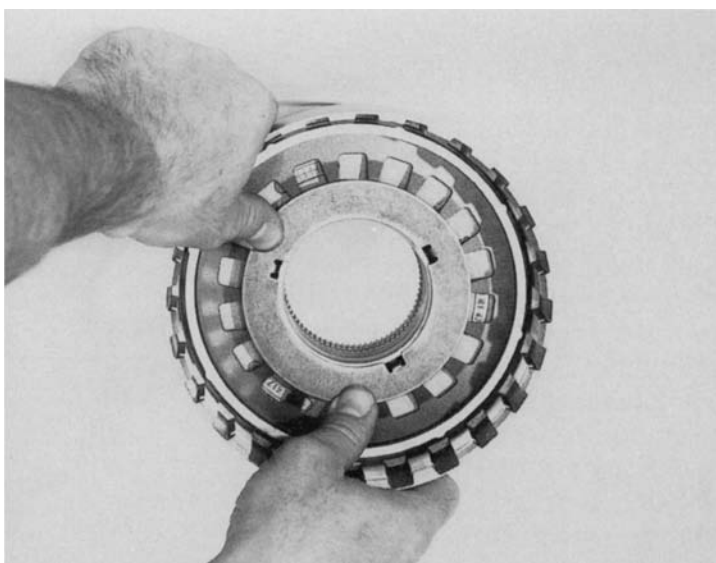

91 097

Place cylinder DG on complete carrier and press on fully.

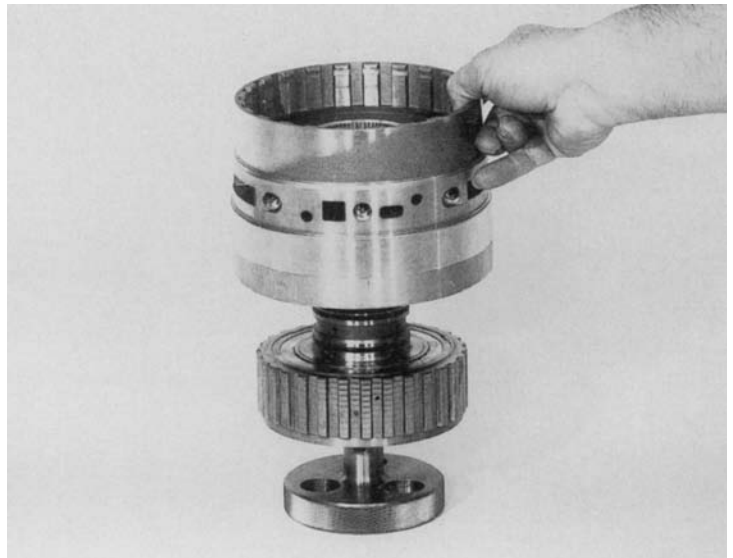

91 098

Insert diaphragm spring G 73.030 on the other side of cylinder DG. Place thrust washer 73.110 in position.

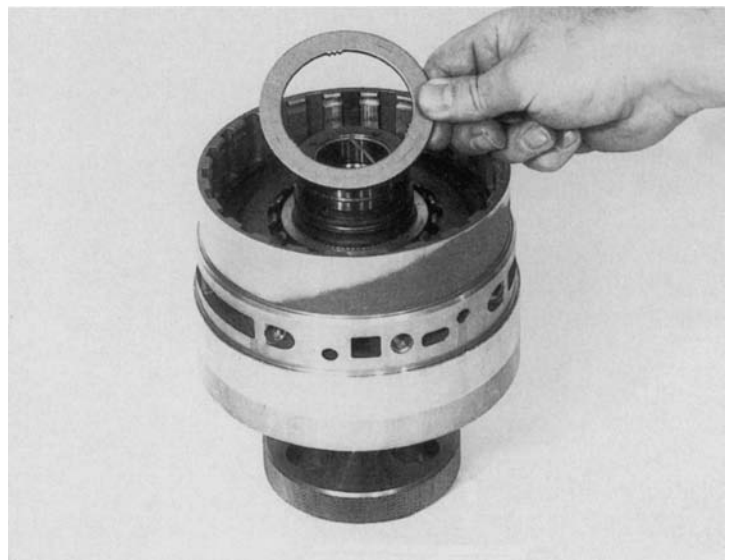

91 099

Place snap ring 73.120 on the cone of assembly fixture 5X46 000 576, and press down slightly with the pressure pad. Place the cone on the hub, push the pressure pad (with cover) over it and insert the hoop of the fixture into the cylinder. Press the complete unit down in the mandrel press.

**Warning:**

The serrations on the thrust washer must slide into the splines on the carrier as this is done.



91 100

Apply a light coat of grease (Vaseline) to the two rectangular-section rings 73.130 and 73.140, and install them on the carrier. Insert the correctly dimensioned disc cluster G, starting with spring disc 73.040 and continuing with steel discs 73.050 and lined discs 73.060 alternately. Insert the final disc 73.070 and secure with snap ring 73.080.

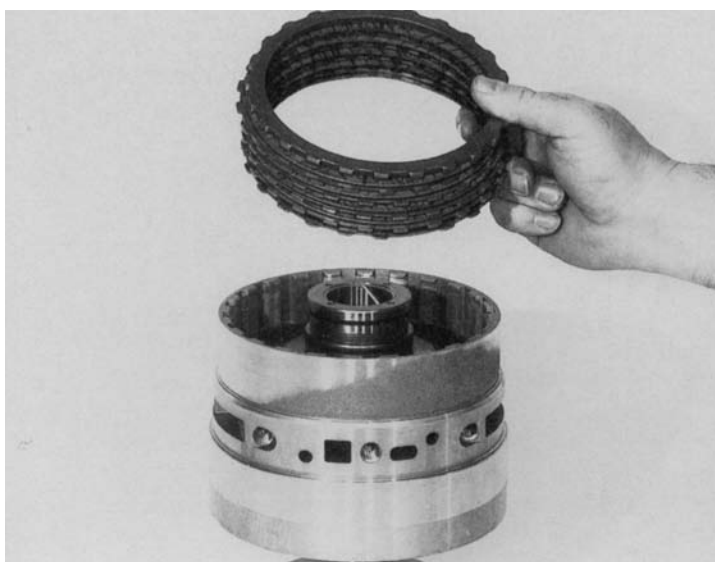

91 101

Turn the complete unit round and remove the counter-holder. Insert the correctly dimensioned disc cluster D, starting with spring disc 73.010/160. This is followed by steel discs 73.010/170 and lined discs 73.010/180 alternately. Insert the final disc 73.010/190 and secure with snap ring 73.010/200.

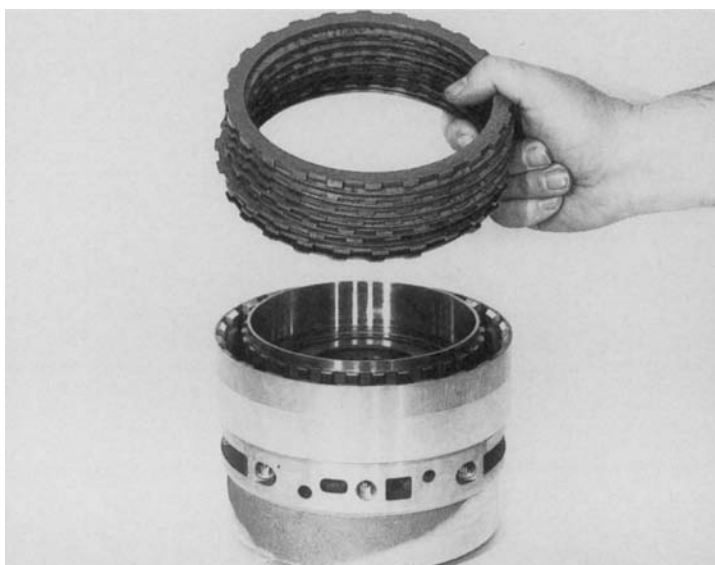

91 102

Place clutch F on planetary gear set III, turning in both directions until the serrated edges of the lined discs and the splines in the hollow gear engage with one another fully. Check through the cutouts in the cylinder: the final disc must not be pressed up by the lined discs. The gap at the top must be wider than at the bottom.

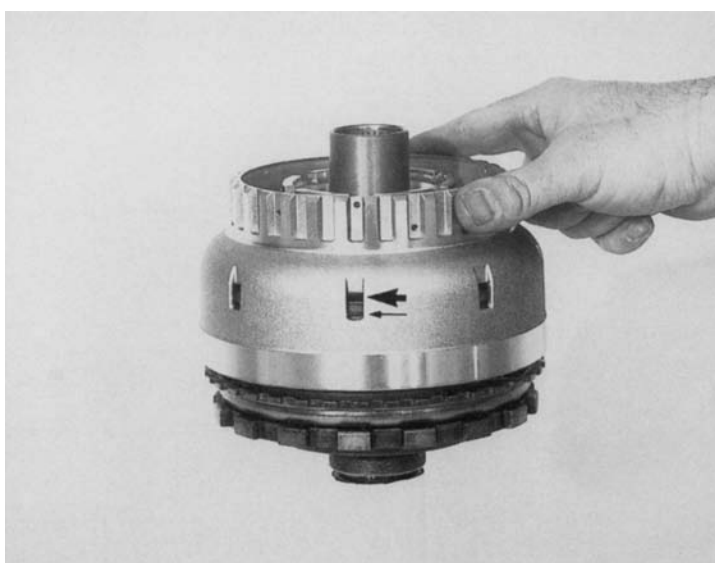



91 103

Using the same procedure, install brake DG with 1st gear freewheel on clutch F, and insert lifter 5 X 46 000 545 into the carrier of the complete planetary gear set (tower). Press down the lever in the centre. Note that this will not be possible if brake DG is incorrectly mounted on clutch F.



91 104

Insert the tower into the transmission housing, aligning the 3 holes.

**Warning:**

The transmission housing must remain vertical while this is being done.

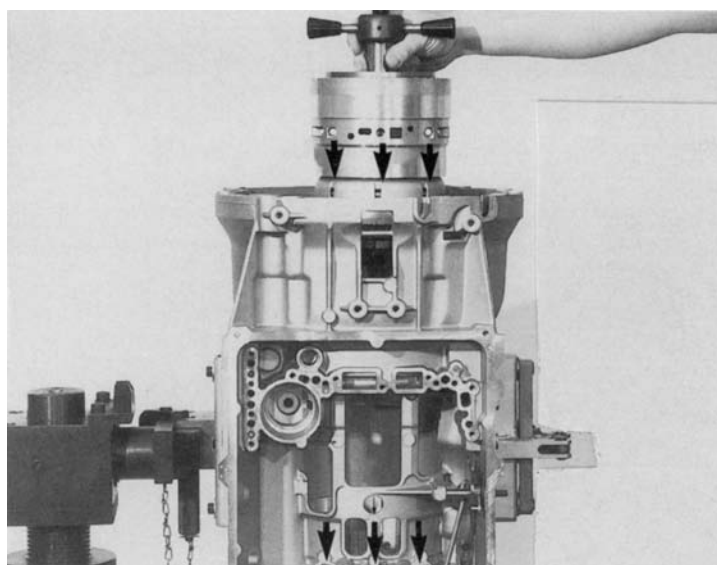

91 105

**Important:**  
comply with the following tightening instructions:

1. Insert the three machine screws 73.200 by about 2 turns.
2. Preload the centre screw initially at 30 Nm, then at 63 Nm.
3. Tighten the two outer screws to a torque of 15 Nm, then 30 Nm and finally 63 Nm.

(Wrench size = TORX TX 50)

The lifter must remain installed; turn the transmission through 180 degrees.

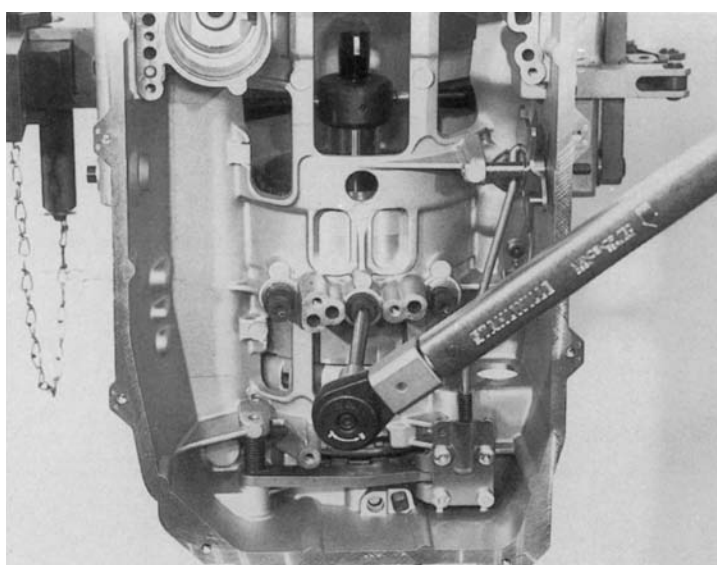

### 3.3 Output side

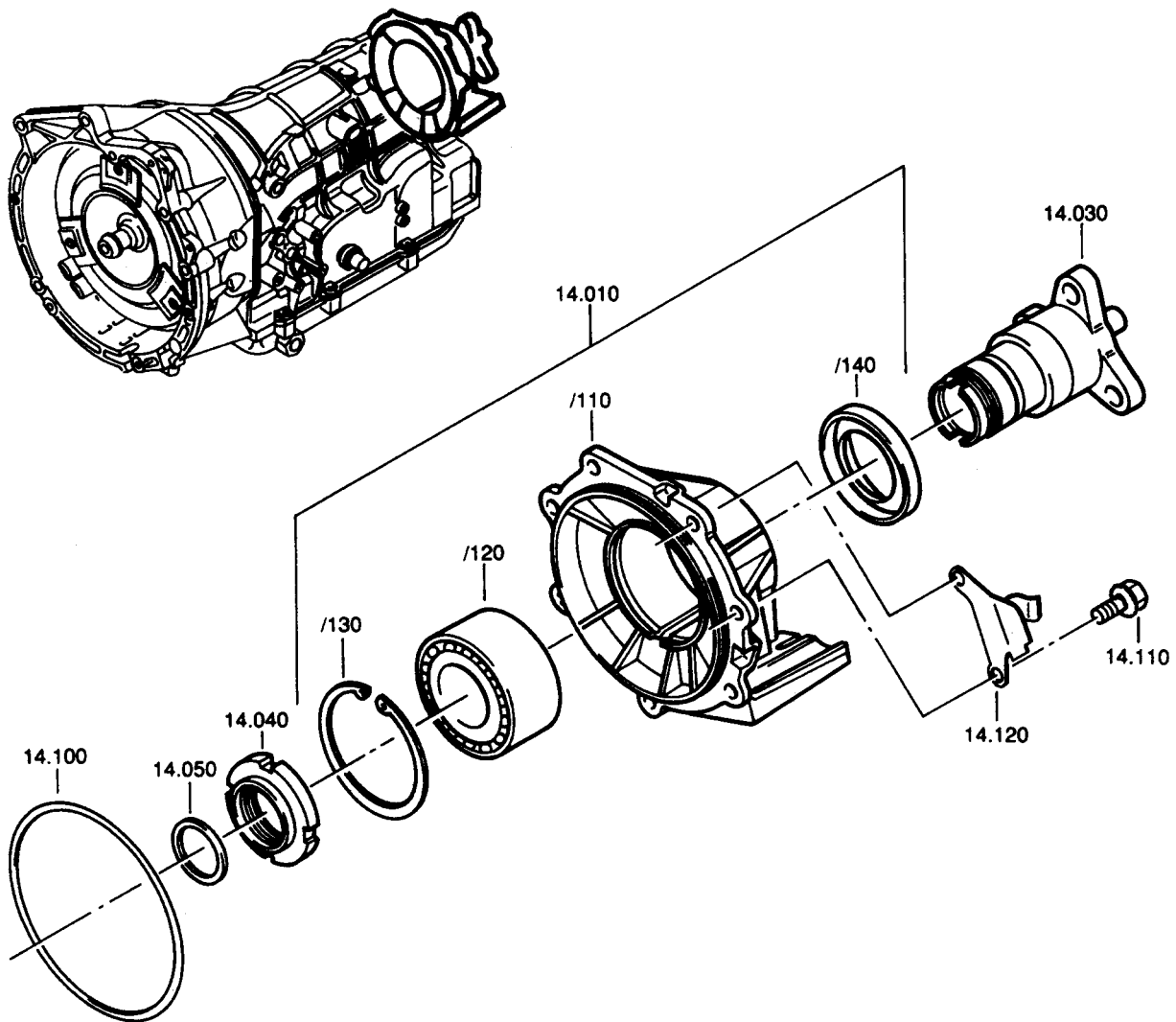

91 106

Place extension 14.010/110 on the contact surface of pressing-in device 5 X 46 000 760.

Place ball bearing 14.010/120 on the pressing-in pin of the tool. Press it into the extension using the mandrel press, and secure with snap ring 14.010/130.

#### **Warning:**

Do not accidentally interchange or turn the two inner bearing races. The cutouts at the edge must face each other.



91 107

Turn the extension round and install shaft sealing ring 14.010/140 in the mandrel press, using pressing-in pin 5 X 46 000 761. Pul on O-ring 14.100.

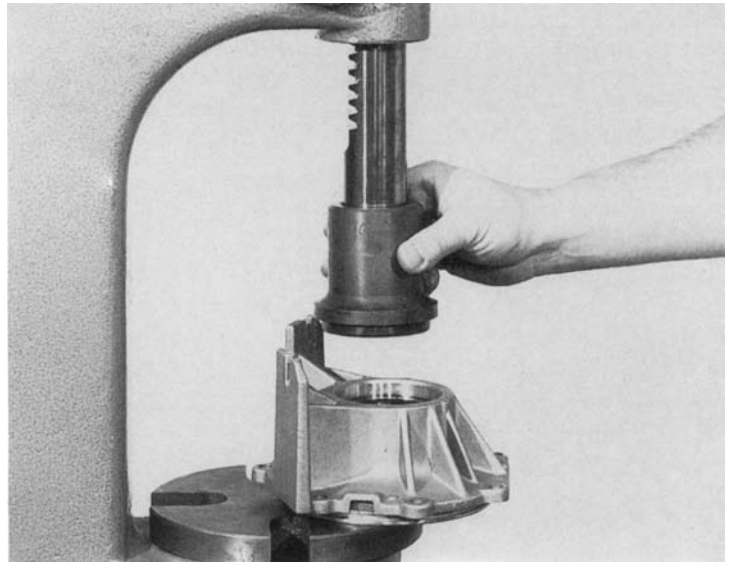

91 108

Place output flange 14.030 on holder 5 X 46 000 542. Place extension on output flange.

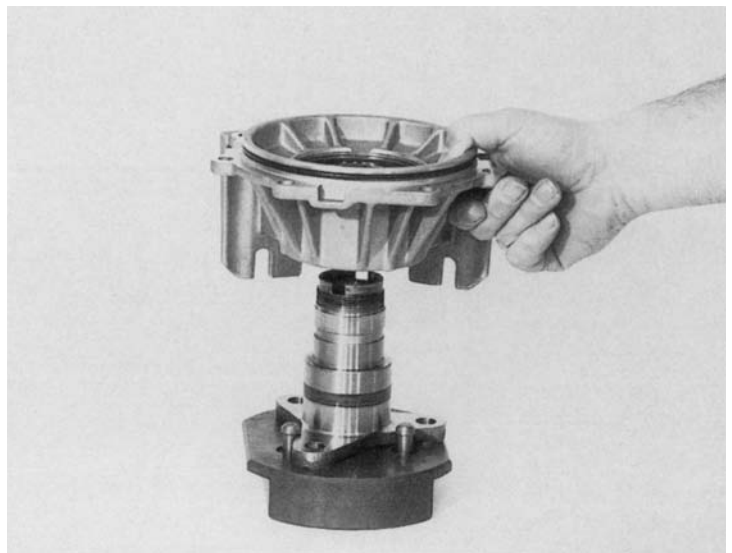

91 109

**Use the vise!**

Screw slotted nut 14.040 on to the output flange and tighten down with socket wrench 5 X 46 000 541.

(Tightening torque = 120 Nm)

Secure the nut with punch marks at two points on its circumference.

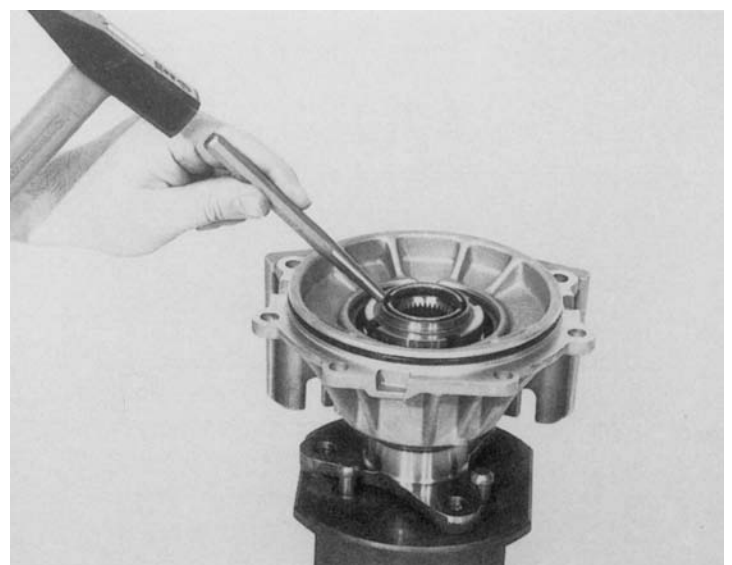

91 110

Place washer 14.050 on the parking interlock gear in the transmission housing.

**Important: adjusting work is needed (see item 1.4.4, Page 5.4)**



91 116

Install the output side assembly and tighten down with 7 hex bolts 14.110. At the same time, secure retaining plate 14.120 in the position illustrated

(Wrench size = 13 mm)

(Tightening torque = 23 Nm)

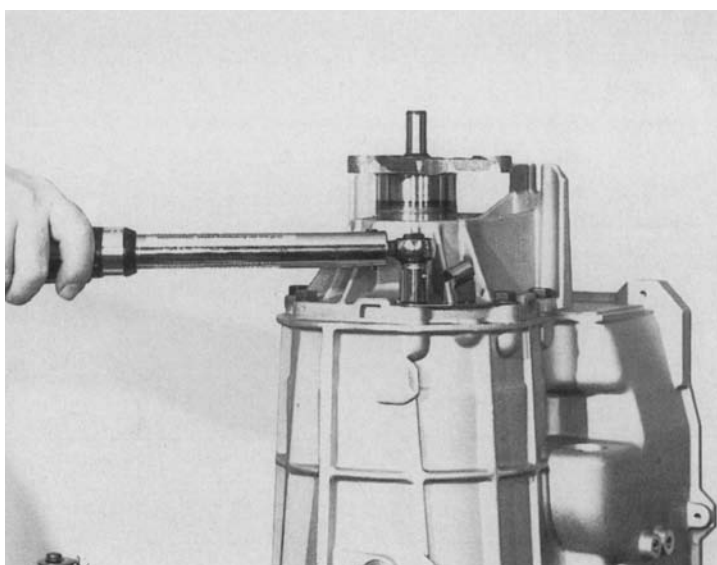

### 3.4 Planetary gear sets I and II

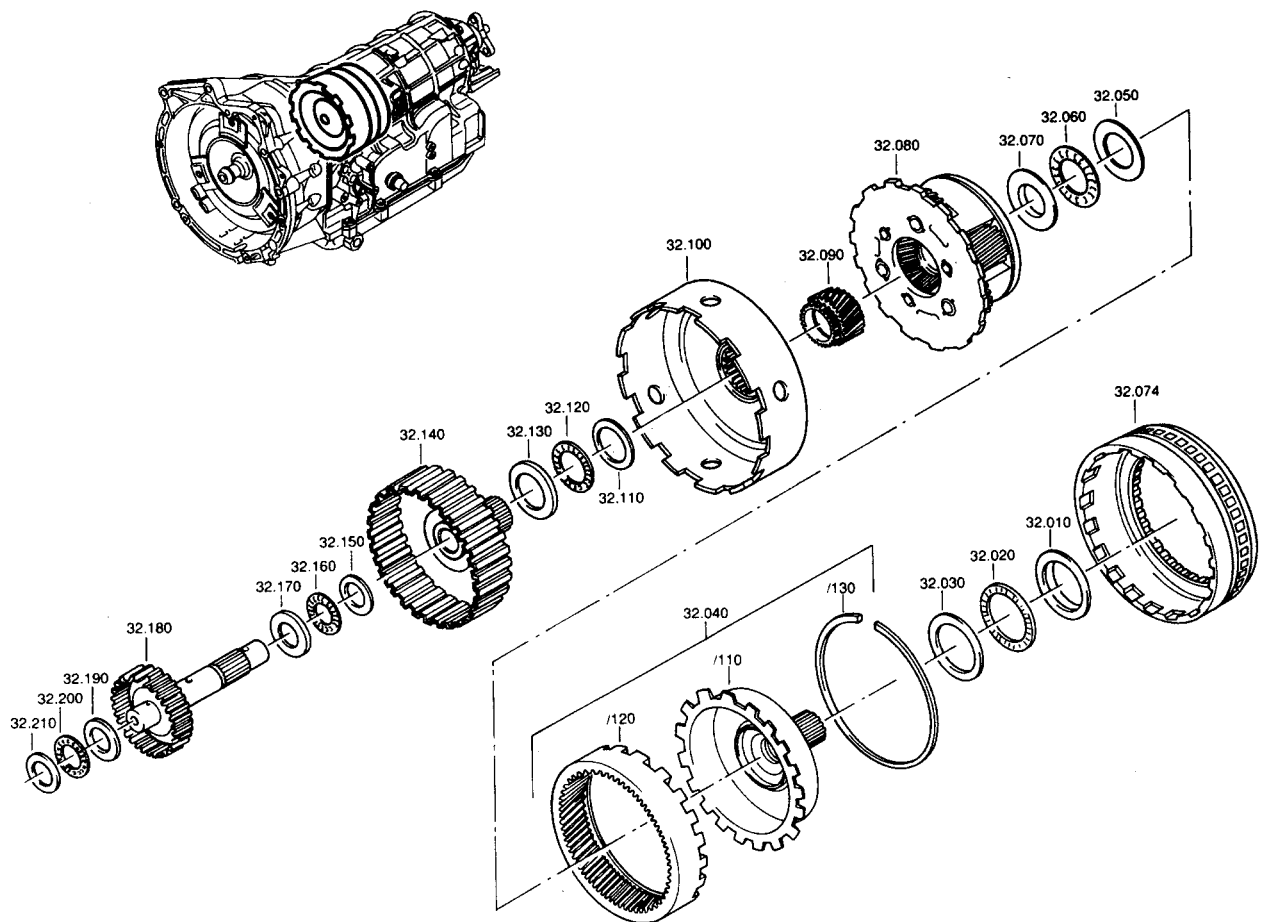

91 117

Turn the transmission through 180 degrees and pull out lifter 5 X 46 000 545 at the centre handle.  
Install case 32.074 on freewheel.

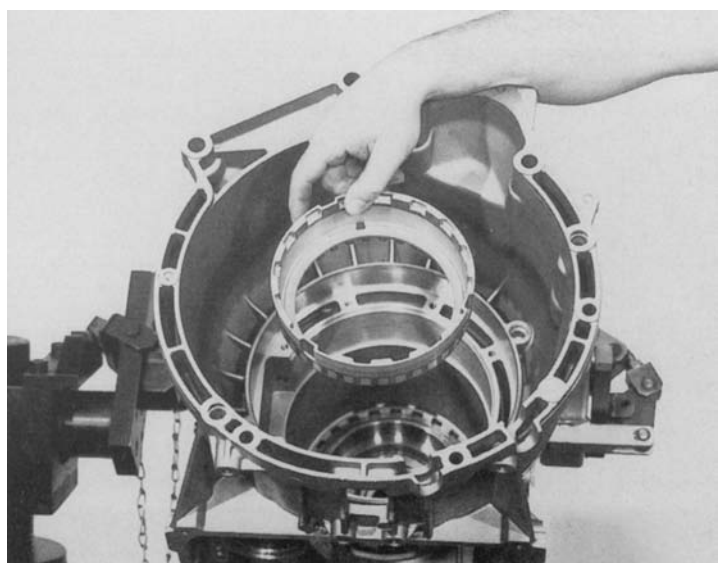

91 118

Insert shaft 32.040/110 into hollow gear, and secure with snap ring 32.040/130.



91 119

Insert angled disc 32.010, needle roller thrust bearing 32.020 and thrust washer 32.030.

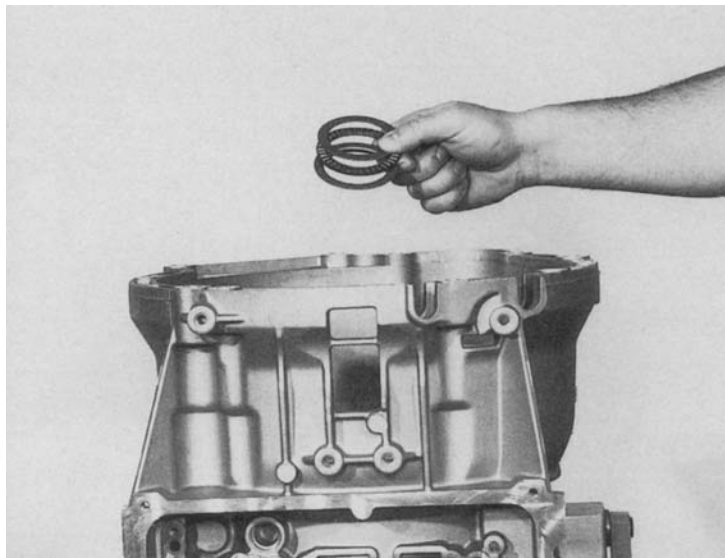

91 120

Insert the output shaft with the hollow gear into the transmission housing.

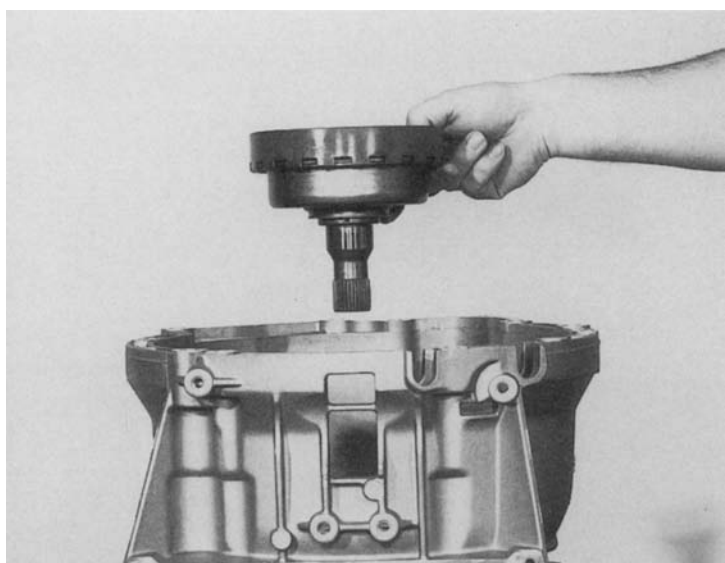

91 121

Install thrust washer 32.050, needle roller thrust bearing cage 32.060 and angled disc 32.070.

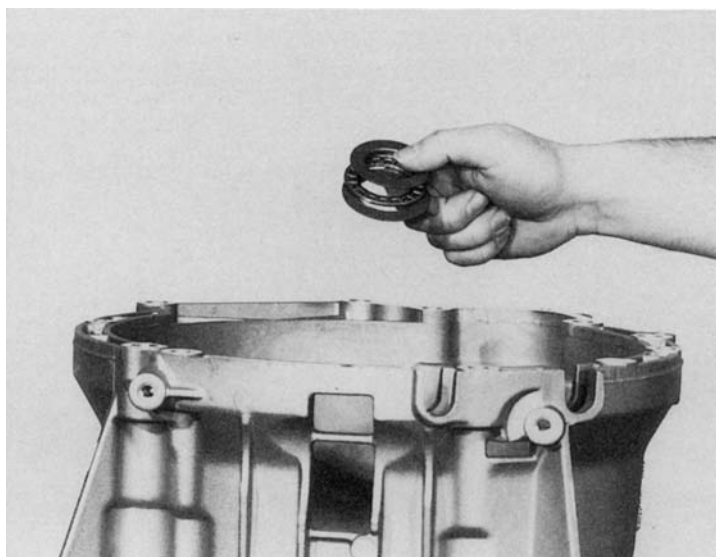

91 122

Place planet carrier 32.080 in transmission housing.

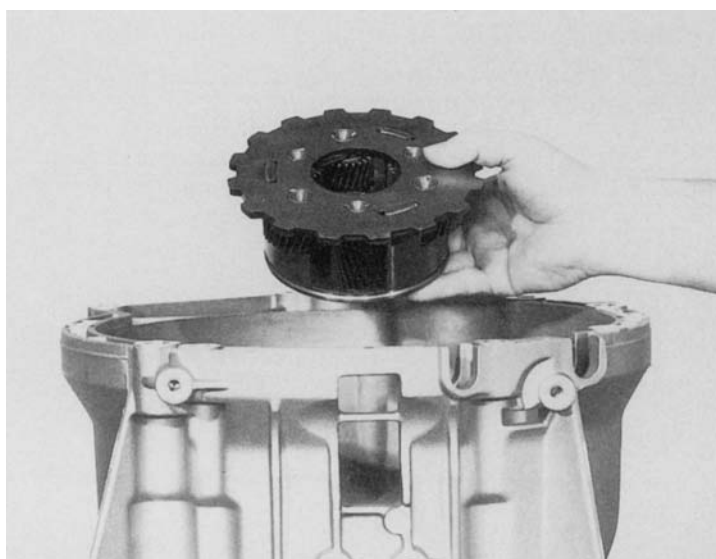

91 123

Place sun wheel 32.090 in planet carrier.

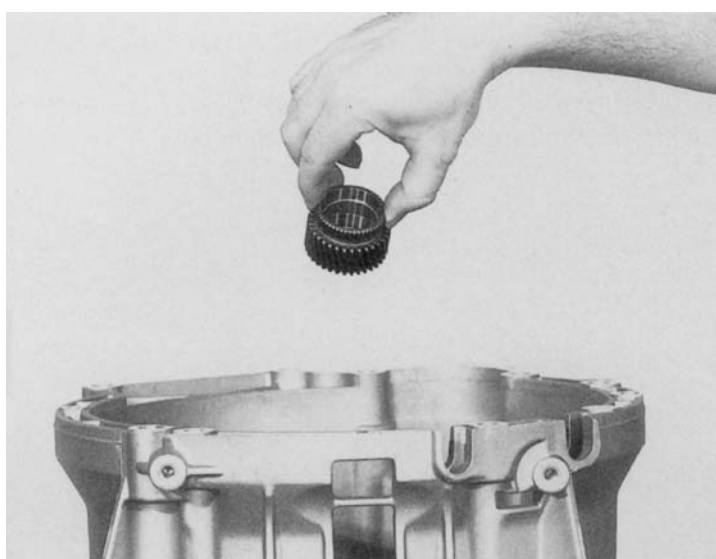

91 124

Place case 32.100 on sun wheel splines.

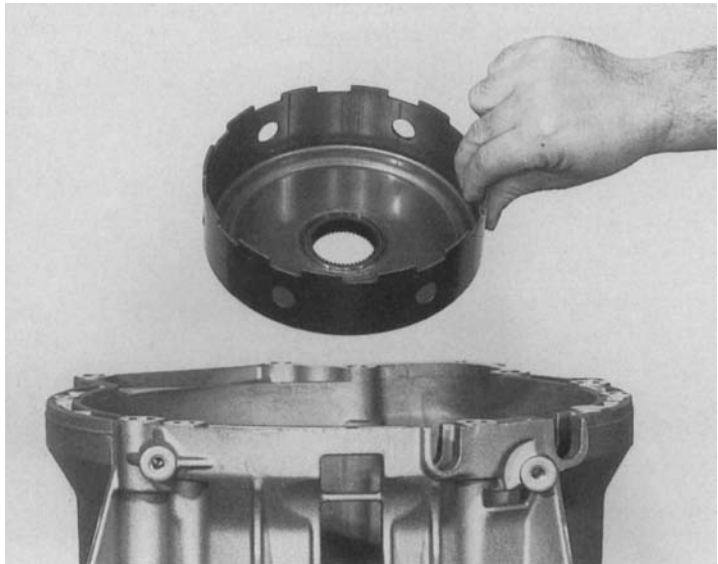

91 125

Place thrust washer 32.110, needle roller thrust bearing cage 32.120 and angled disc 32.130 in the case.

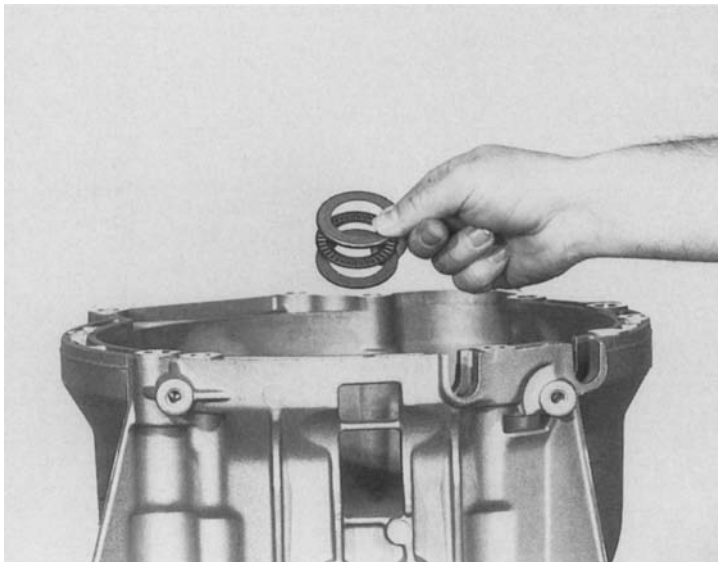

91 126

Insert sun wheel 32.140 and check for correct function. If assembly was correct, the case will turn in the opposite direction to the sun wheel.

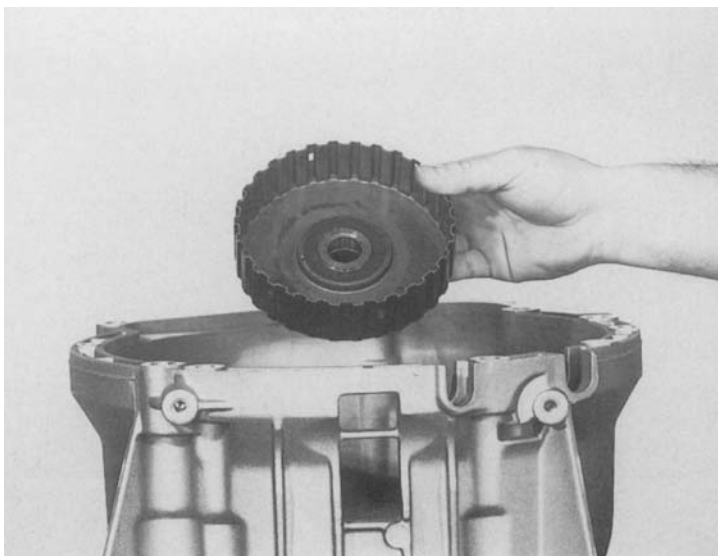



91 127

Push angled disc 32.170, needle roller thrust bearing cage 32.160 and thrust washer 32.170 over the end of intermediate shaft 32.180, and install the intermediate shaft.

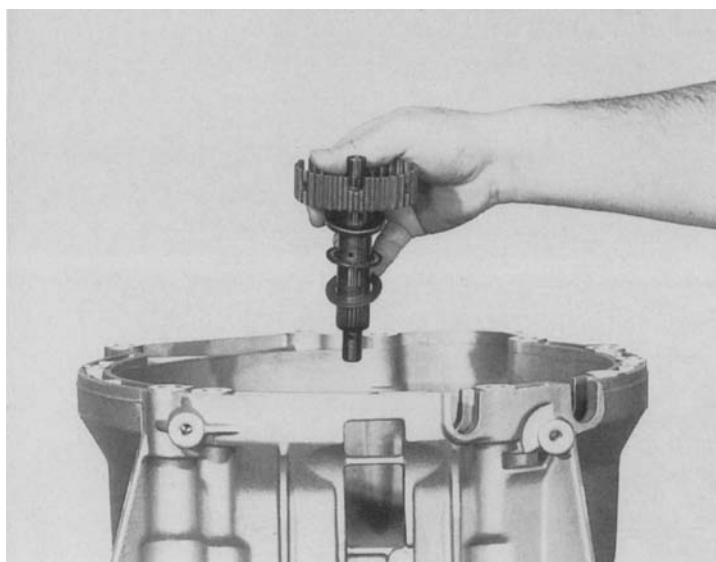

91 128

Place thrust washer 32.190, needle roller thrust bearing cage 32.200 and thrust washer 32.210 over the intermediate shaft journal.



### 3.5 Input side

#### 3.5.1 Clutch E

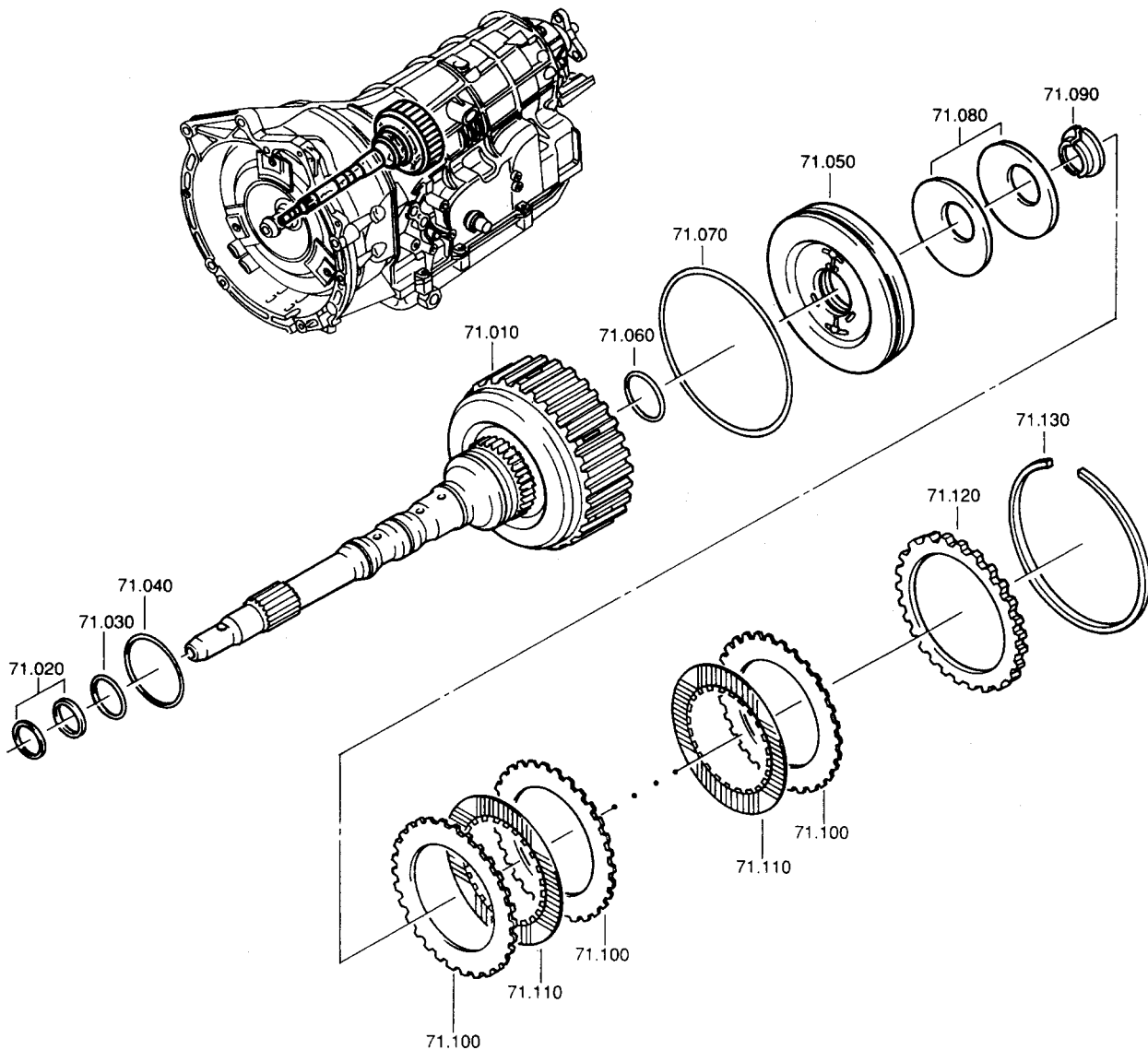

91 129

Install new O-ring seals 71.060 and 71.070 on piston E 71.050, and grease lightly (with Vaseline).

Pres piston E into the complete input shaft cylinder 71.010.



85 260

Place the two diaphragm springs 71.080 on the piston, press down in the mandrel press using assembly fixture 5 X 46 000 863 and secure with the split retaining ring 71.090.

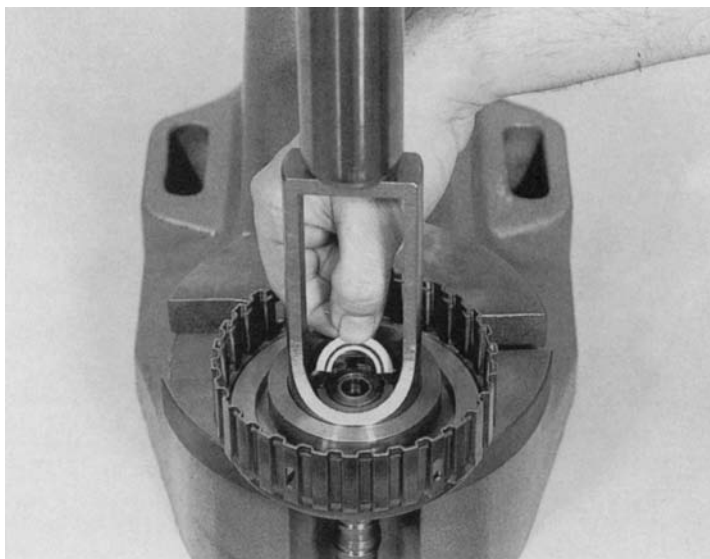

91 130

Insert the complete set of discs for clutch E, starting with outer disc 71.100 and continuing alternately with lined disc 71.110 and the outer disc. Install final disc 71.120 and secure with snap ring 71.130.

**Warning: adjustment work is needed (see item 1.4.5, Page 5/6)**

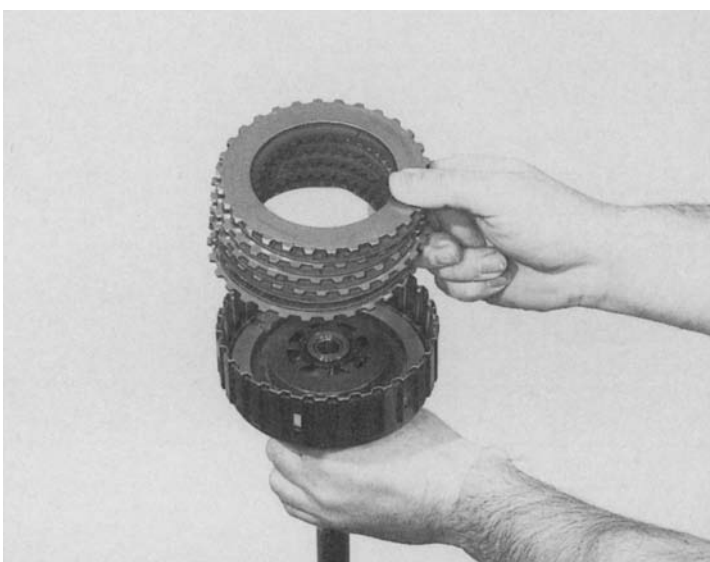

91 134

Install the two rectangular-section rings 71.020 and 71.030 on the input shaft. Pull on O-ring 71.040 and coat all rings with grease (Vaseline).

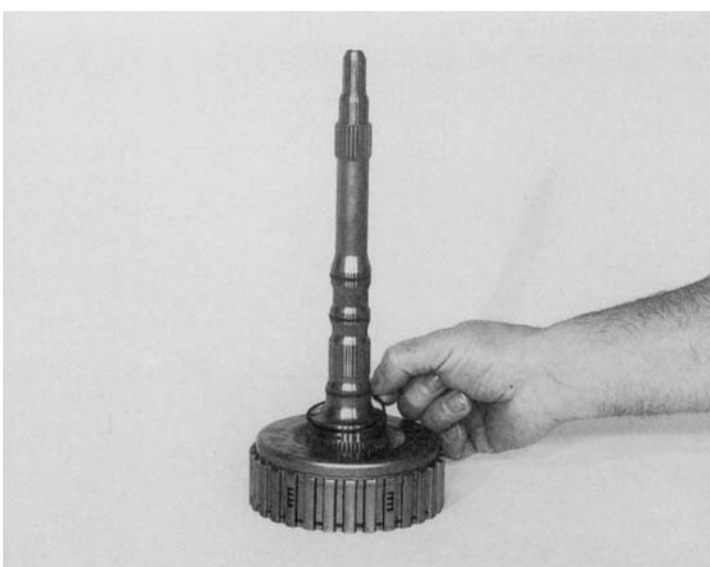

### 3.5.2 Clutch A

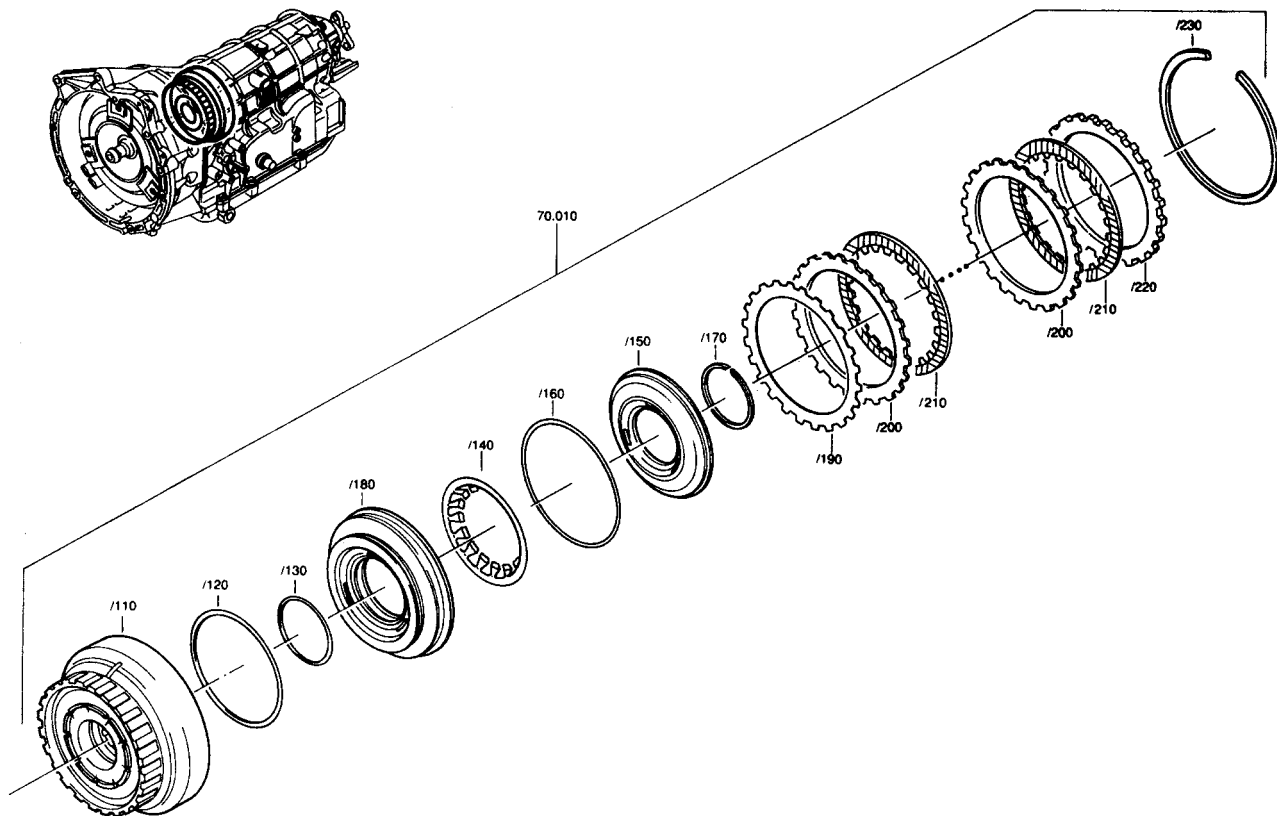

85 196

Install new O-ring seals 70.010/120 and 70.010/130 on piston 70.010/180, and grease lightly (with Vaseline).



91 135

Press piston A into cylinder A (70.010/110) and insert diaphragm spring 70.010/140 with the convex side upwards.

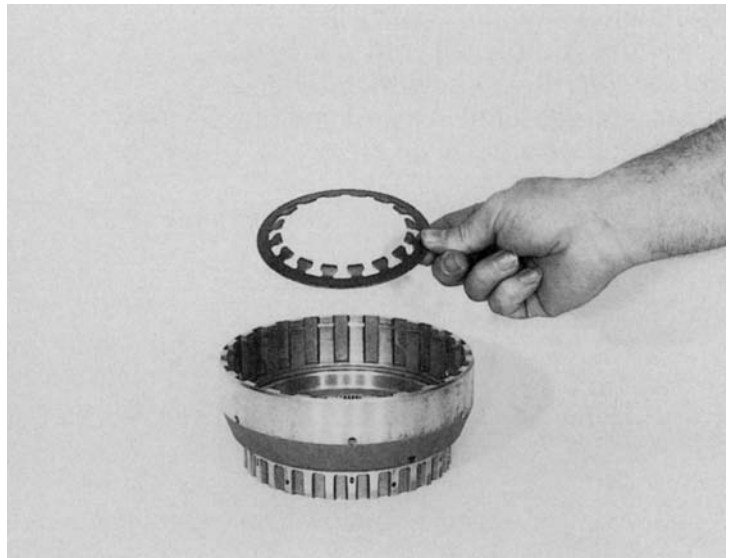

85 267

Pull O-ring seal 70.010/160 on to retaining disc 70.010/150 and grease lightly (with Vaseline).

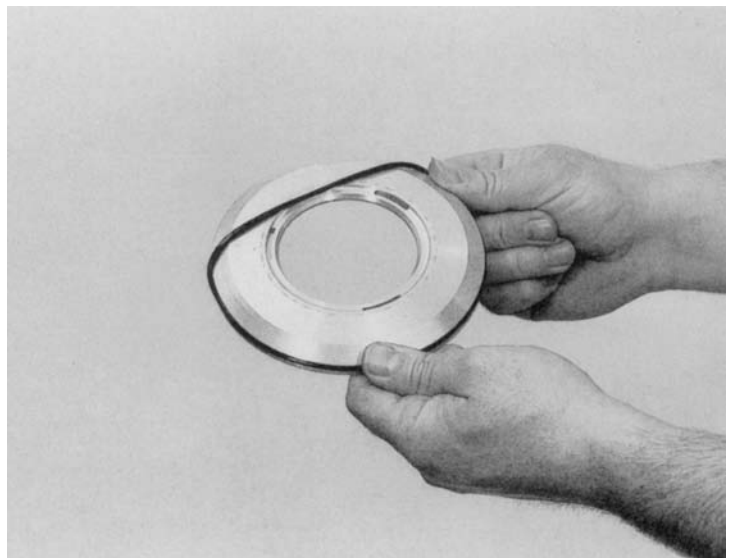

85 268

Insert the retaining disc and press it down with the hoop of special tool 5 X 46 000 167. Snap ring 70.010/170 can be pressed into position by hand, or suitable pliers used if necessary.

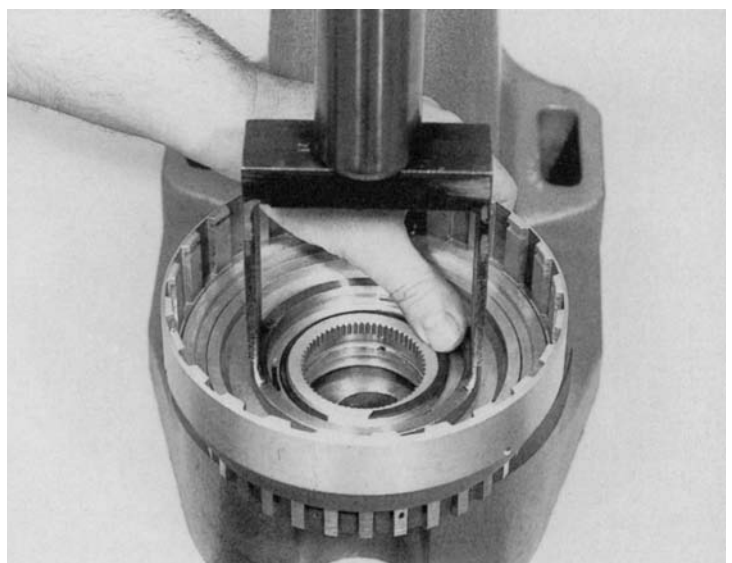

85 269

Insert the complete disc cluster for clutch A, starting with spring disc 70.010/190 and continuing alternately with outer discs 70.010/200 and lined discs 70.010/210.

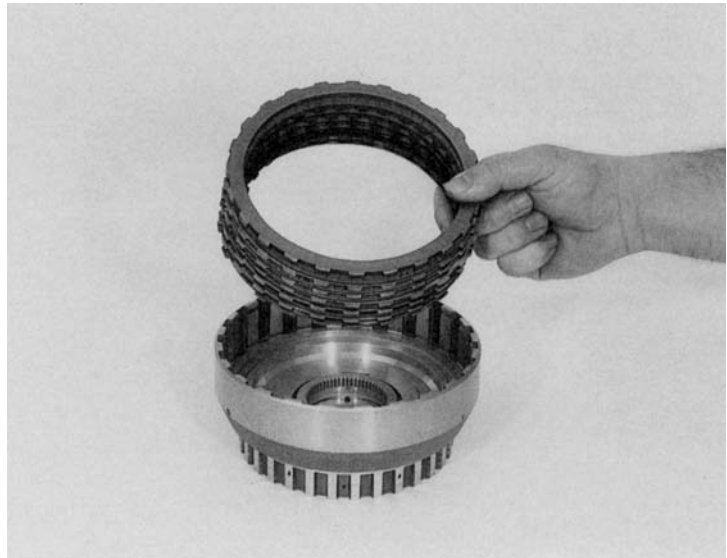

85 270

Place final disc 70.010/220 in position and secure with snap ring 70.010/230.  
**Warning: adjustment work is necessary (see item 1.4.6, Page 5/7)**

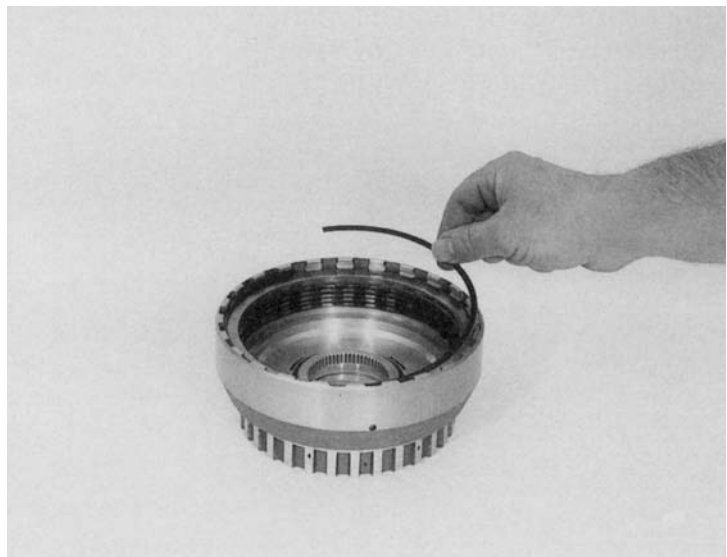

### 3.5.3 Clutch B and 3rd gear freewheel

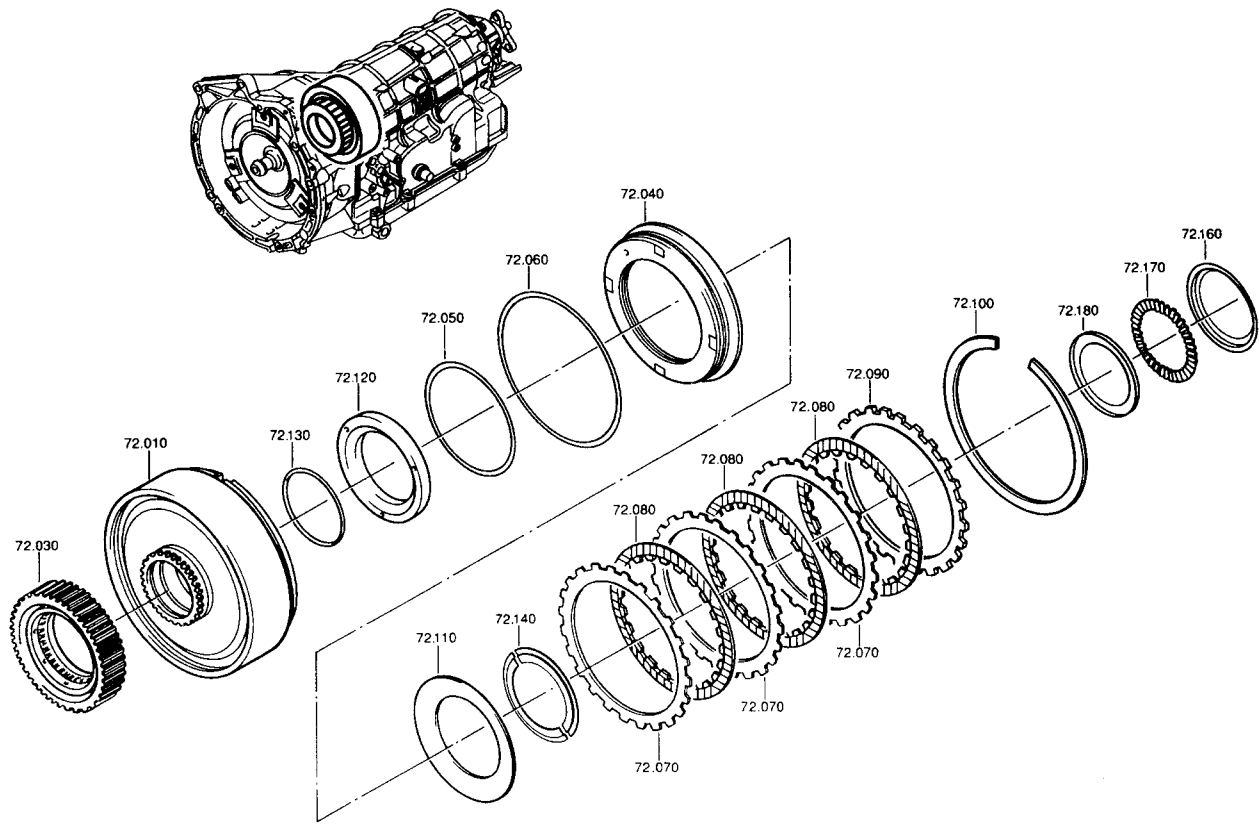

Pull new O-ring 72.130 on to hub or cylinder B 72.010, and grease lightly (with Vaseline).

85 277



85278

Press intermediate ring 72.120 fully into the cylinder with its chamfered side facing down.

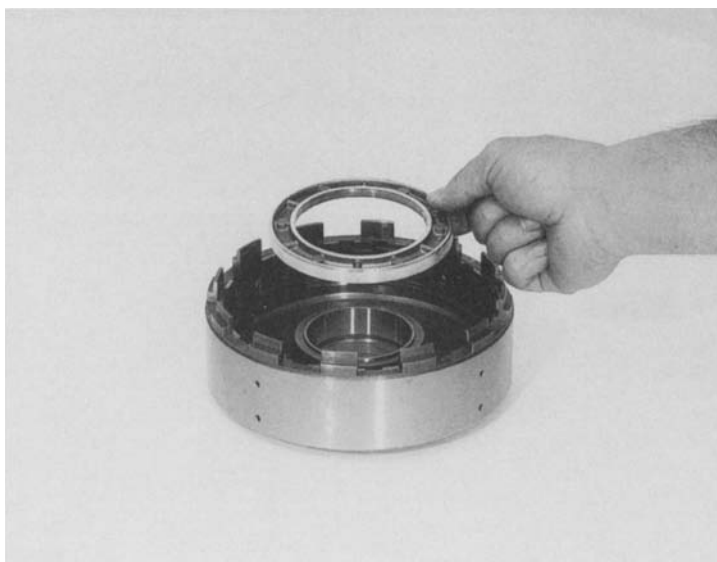

85280

Pull new O-ring seals 72.050 and 72.060 on to piston B 72.040 and grease lightly (with Vaseline).

Press the piston into the cylinder.

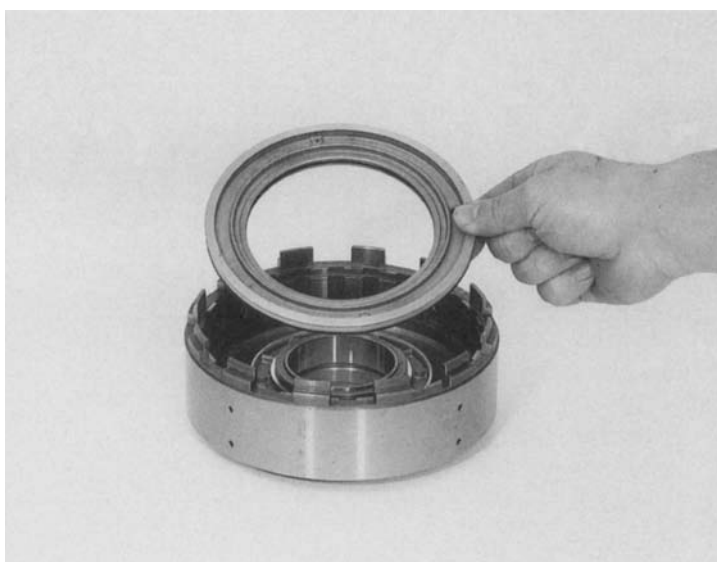

91136

Install the centering ring of assembly fixture 5 X 46 000 221 and place diaphragm spring 72.110 in position. Press down in the mandrel press using fixture 5 X 46 000 221 and secure with retaining ring 72.140 by pushing the two halves of this ring together.

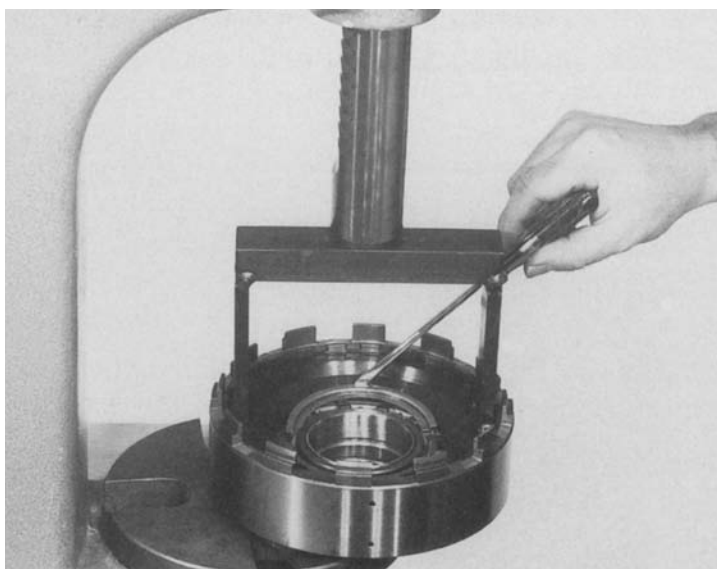



91 137

Install the complete disc cluster for clutch B, starting with outer disc 72.070 and continuing alternately with lined disc 72.080 and an outer disc.

Place the final disc 72.090 on top and secure it with snap ring 72.100.

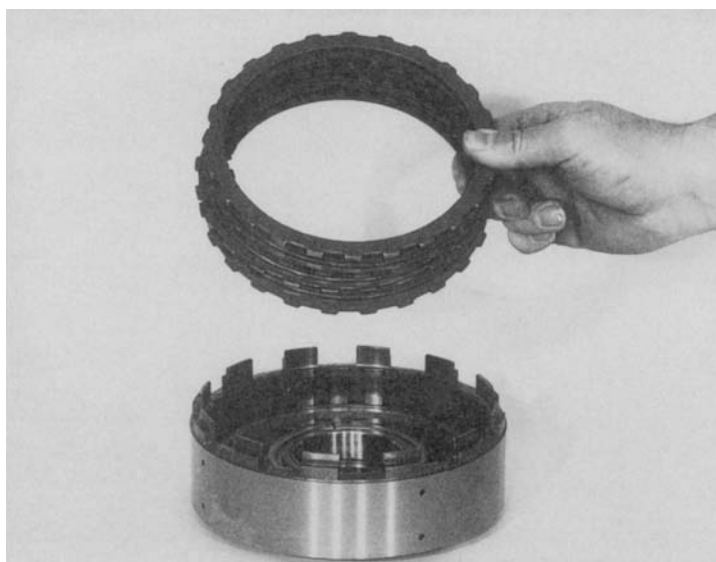

91 138

Pre-assemble the 3rd gear freewheel 72.030 by pressing one of the two cover discs of the freewheel into the outer race of the freewheel initially.

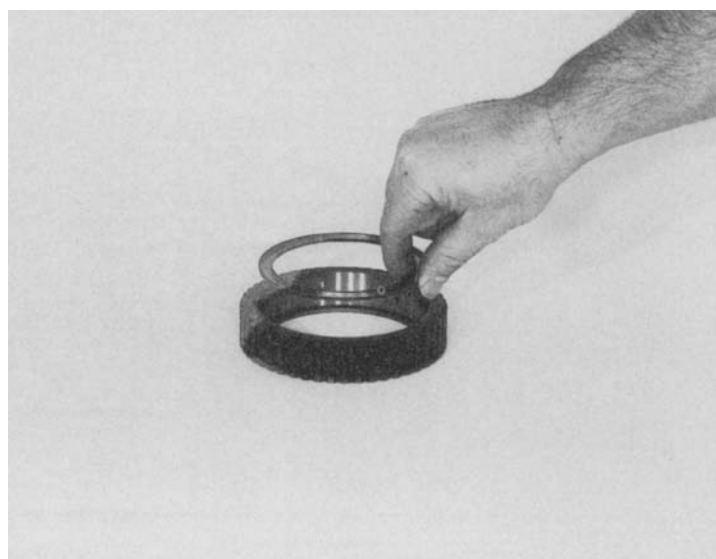

91 139

Insert the freewheel cage with the shoulder downwards.

**Warning:**

If installed incorrectly (the wrong way round), the freewheel will lock in the wrong direction.

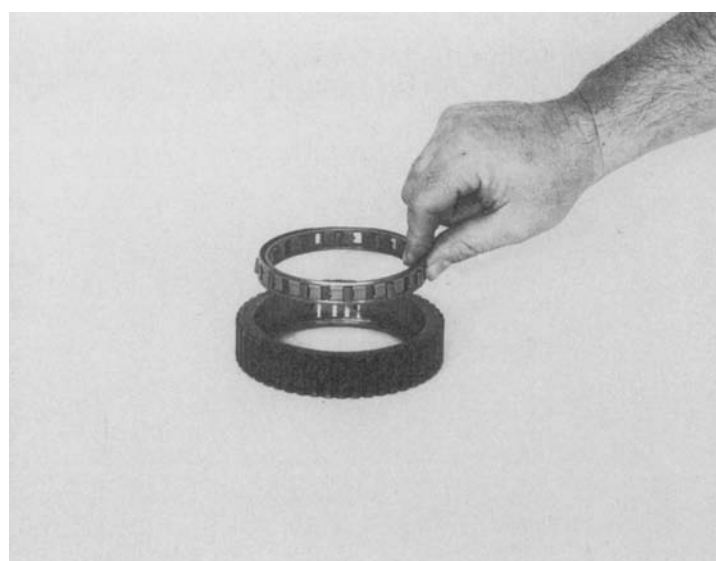

91 140

Place the freewheel cover disc in position and press it in.

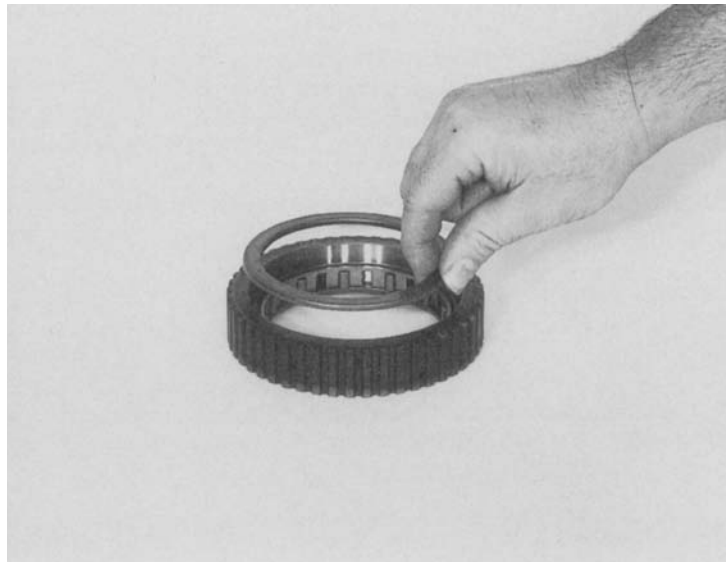

91 141

Insert the inner race of the freewheel from the front, turning it clockwise at the same time.

**Important:**

Check for correct function: it should be possible to turn the inner race of the freewheel freely clockwise at the shoulder or internal splines when the outer race is prevented from moving.

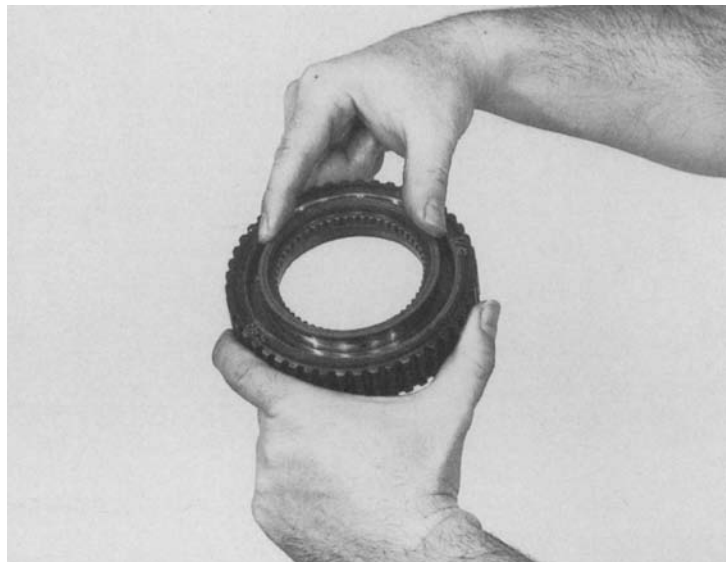

91 142

Insert clutch E at the input shaft, turning it while inserting. Make sure that all the clutch discs are correctly engaged.

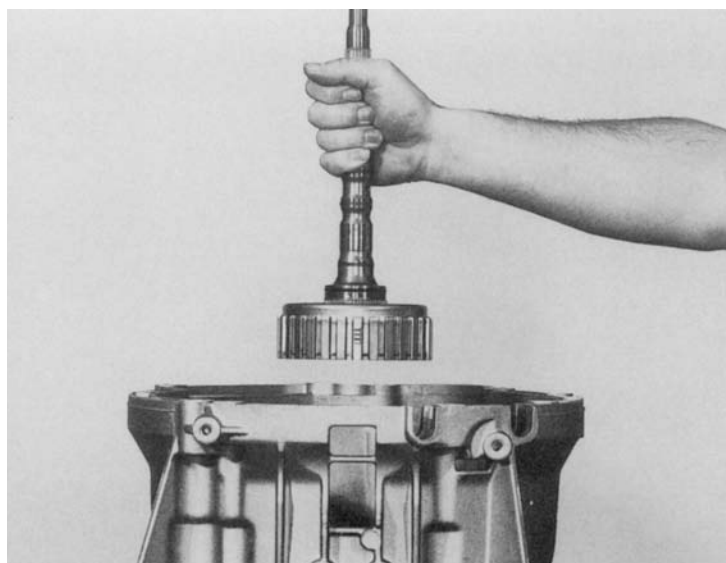

91 143

Insert complete clutch A, turning it at the same time in both directions and ensuring that the disc teeth engage.

**Warning:**

The clutch must slide over the O-ring on the input shaft. The hub of cylinder B should then be heard to strike sheet-metal cylinder E.

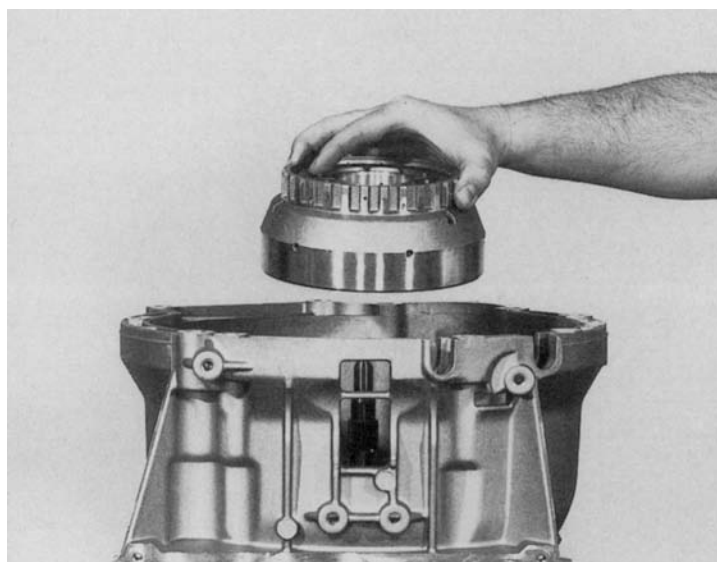

91 144

Insert angled disc 72.160, needle roller thrust bearing 72.170 and angled disc 72.180.

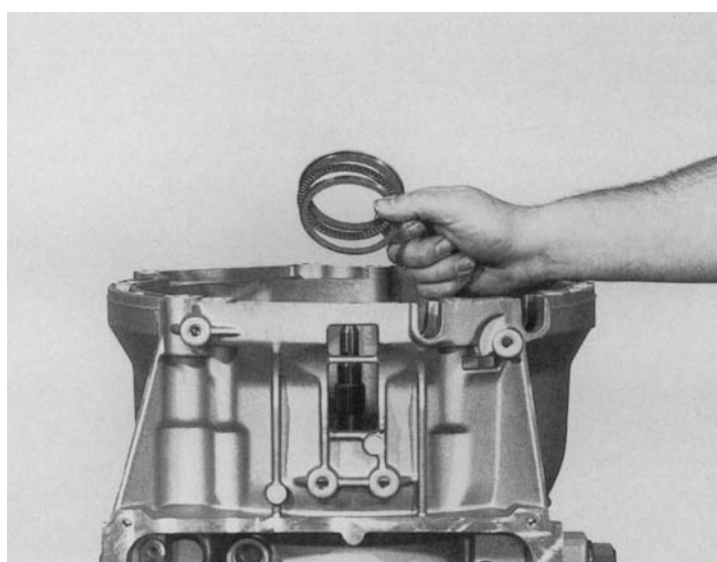

**3.5.4 Brake C<sup>2</sup>**

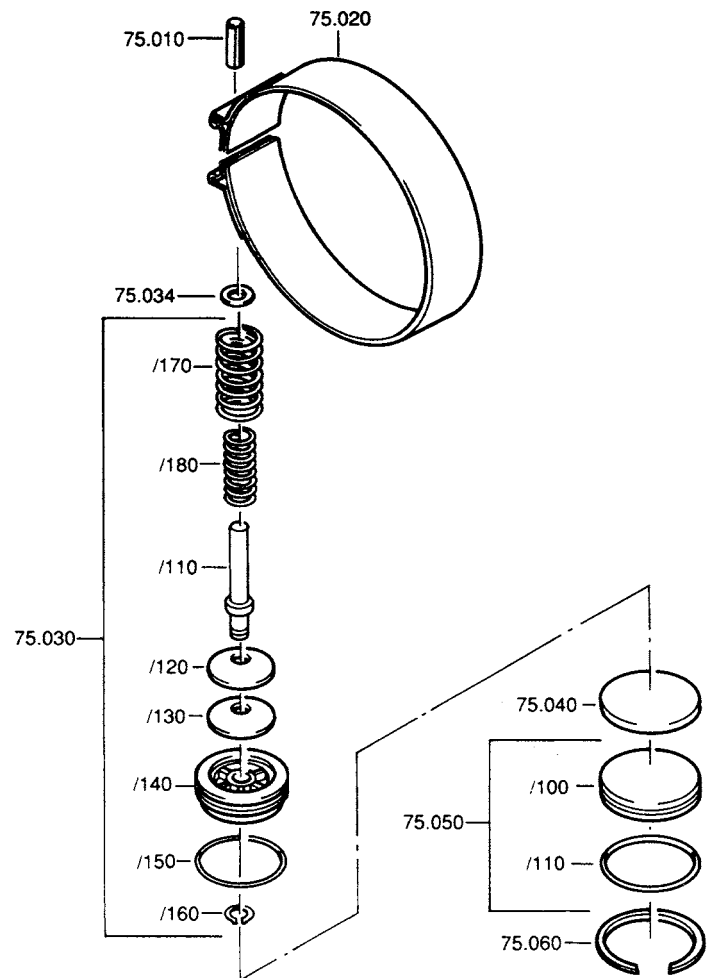
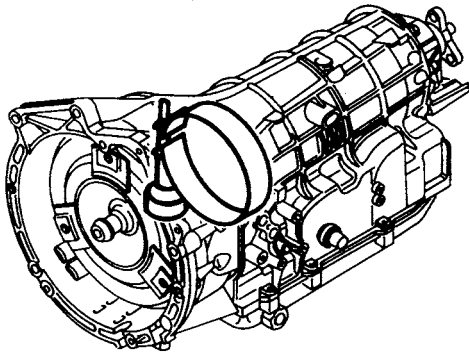

91 145

Press pin 75.010 into the transmission housing and insert brake band 75.020 using the retaining clip. Remove the clip after insertion of the brake band.

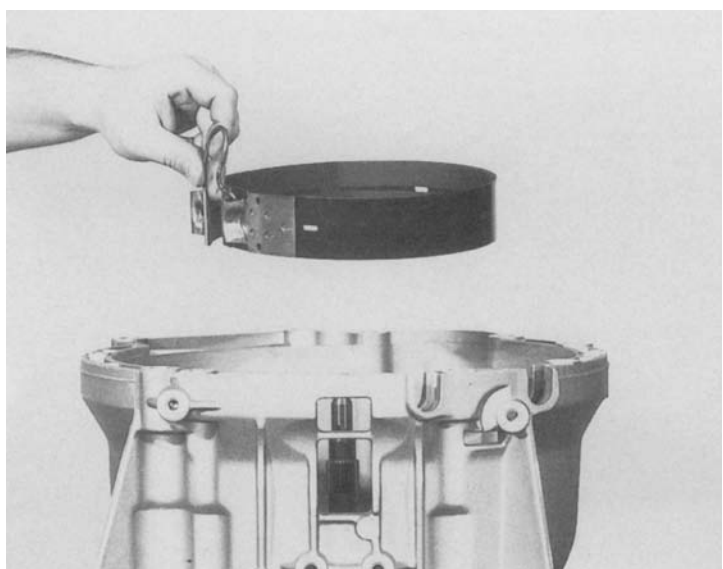

Insert the complete clutch B, turning it in either direction until the discs mesh together fully.

If correctly installed, cylinder B must be engaged in the cutouts on the case so that only a gap of approx. 1 mm is still visible.

**Note:**

Final assembly of brake C<sup>2</sup> and the 3rd gear freewheel should not be undertaken until the necessary adjustments to clutch C<sup>2</sup> and of transmission end play have been carried out.

To do this, first install the oil supply unit with brake C<sup>1</sup>.

**For final assembly, see Page 73.**

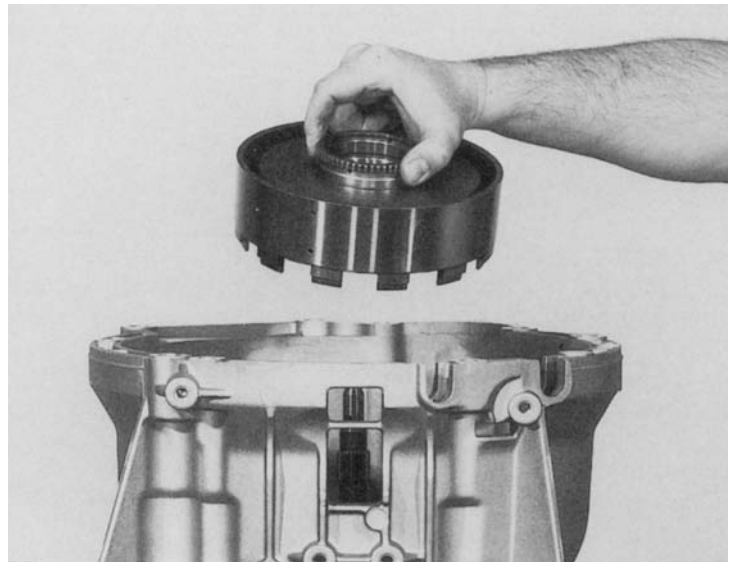

### 3.6 Oil supply unit with brake C'

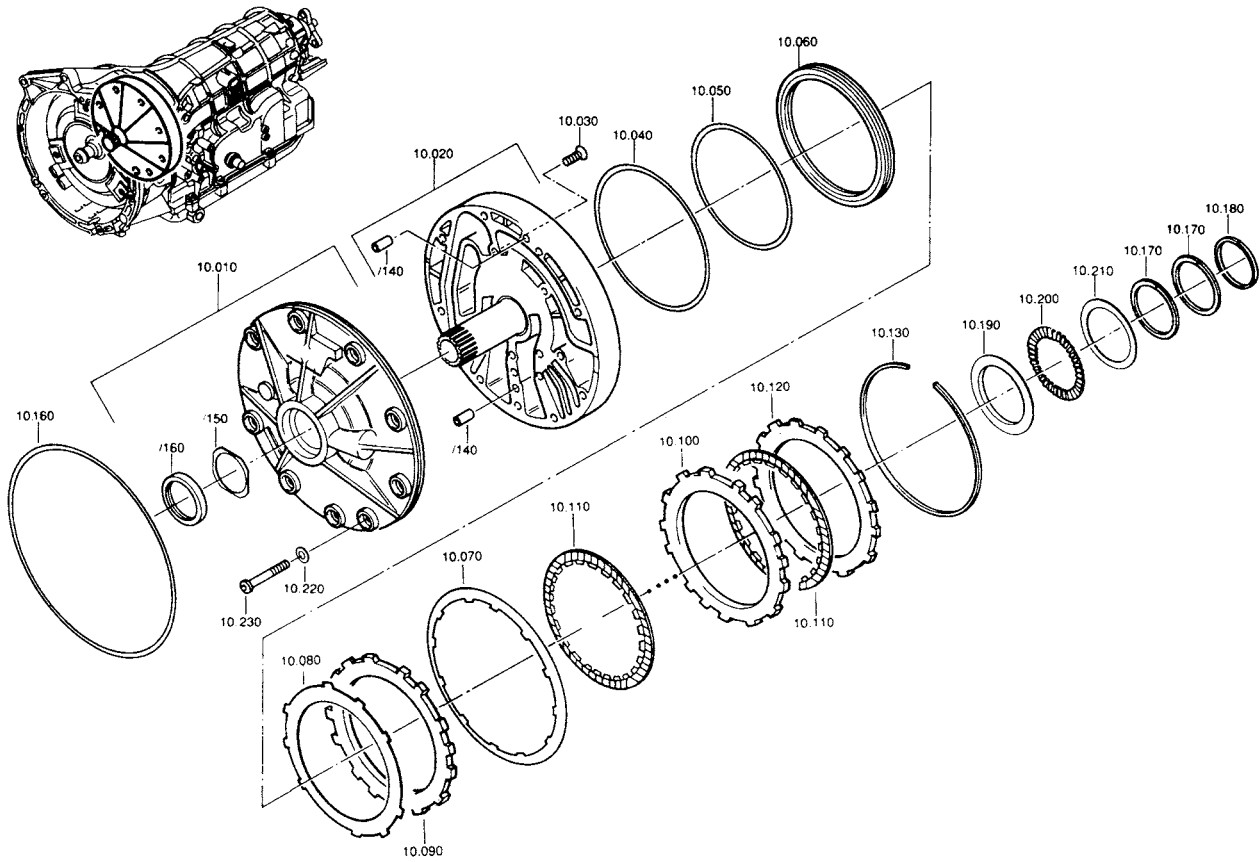

91 147

Insert washer 10.010/150 and use assembly sleeve 5 X 46 000 680 to install shaft sealing ring 10.010/160 in the pump housing.

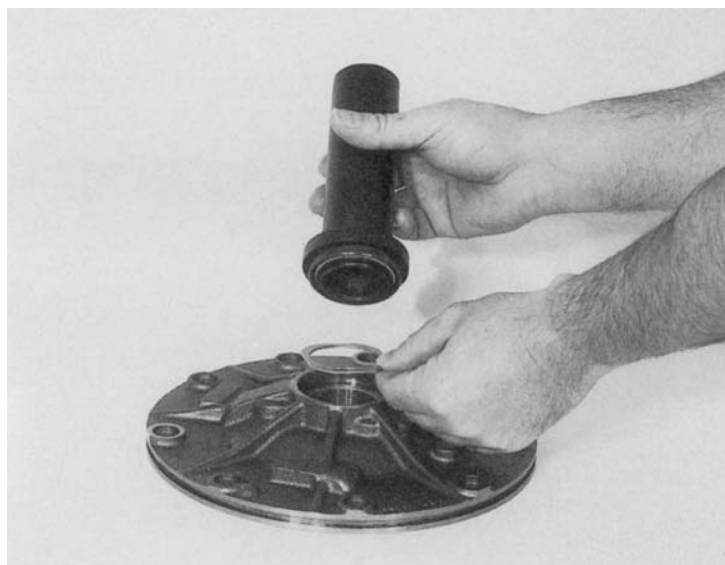

91 148

Pre-assemble pump 10.010, making sure that the marks on the pump gear and the hollow gear are both at the top.

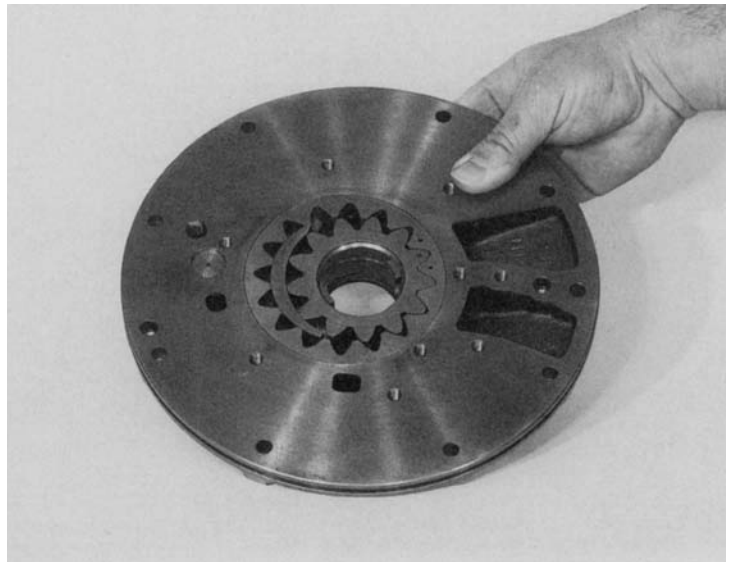

91 149

Using a plastic-faced hammer, drive the two straight pins 10.020/140 into intermediate plate 10.020.

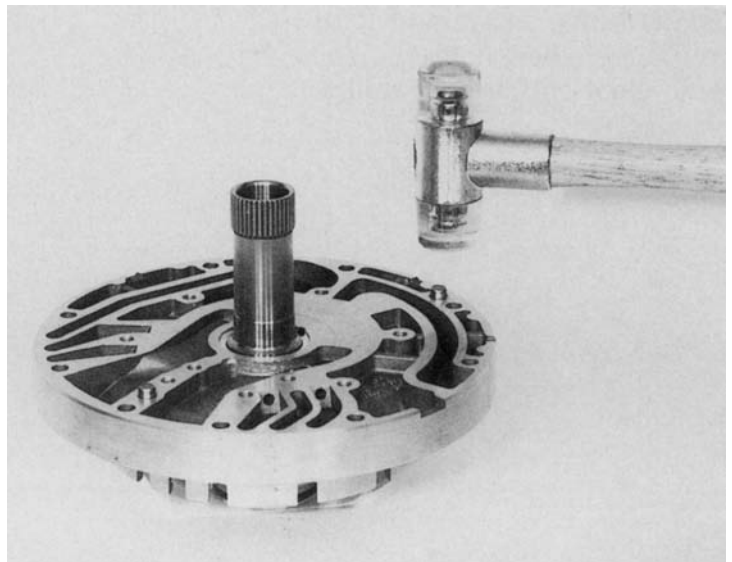

91 150

Place the intermediate plate on the pump and align it.  
Attach it with 9 countersunk bolts 10.030.

(Wrench size = Torx TX 30)  
(Tightening torque = 10 Nm)

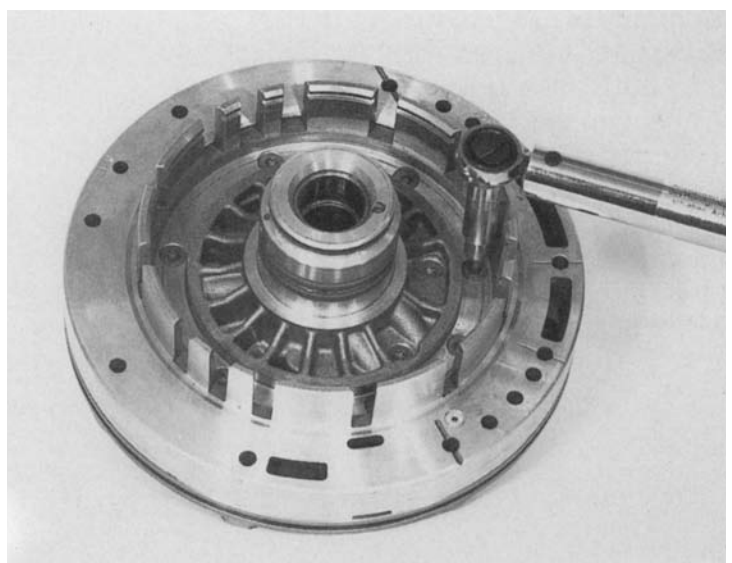

91 151

Place the two rectangular-section rings 10.170 and rectangular-section ring 10.180 on the hub of the intermediate plate and engage in position.

Check free movement of pump with special tool 5 X 56 000 021.

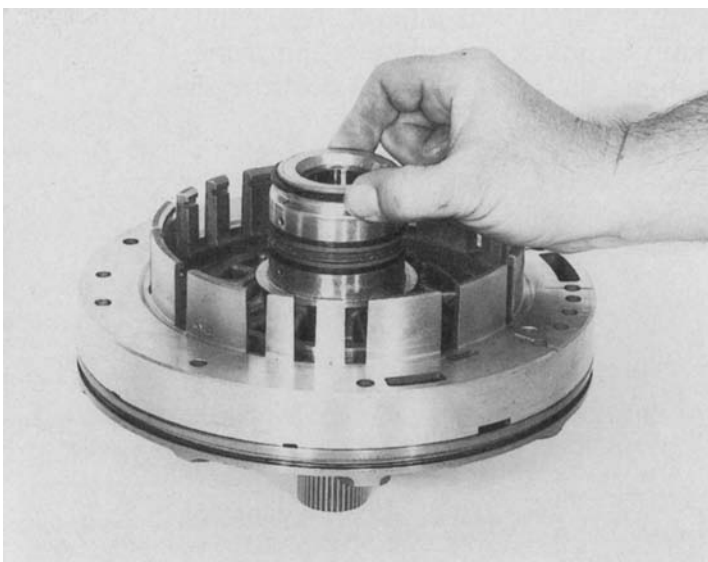

91 152

Pull O-rings 10.040 and 10.050 on to piston 10.060 and grease them lightly (with Vaseline).

Press the piston into the intermediate plate.

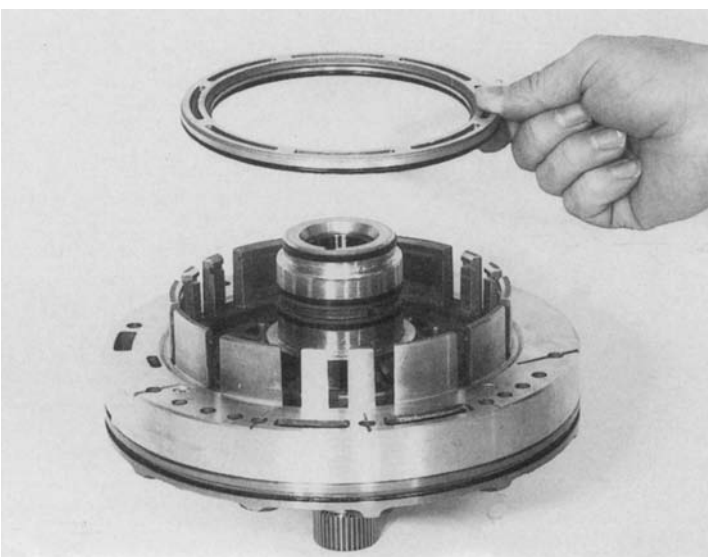

91 153

Install the complete disc cluster for brake C', starting with spring disc 10.080 followed by thick outer disc 10.090.

Insert diaphragm spring 10.070 with the raised outer rim facing you.

Follow this with lined discs 10.110 and outer discs 10.100 alternately.

Place the final disc 10.120 on top.

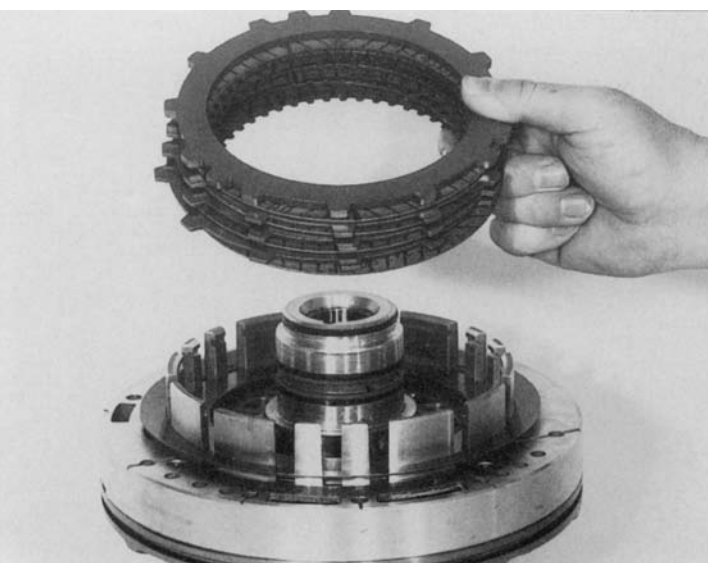



91 154

Secure the final disc with snap ring 10.130.

**Warning: adjustment work is necessary (see item 1.4.7, Page 5/8)**

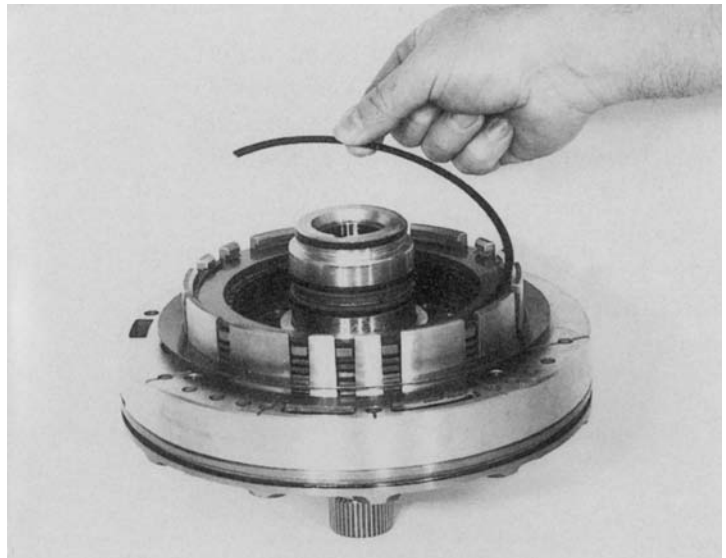

91 158

Use grease (Vaseline) to attach angled disc 10.190, needle roller thrust bearing 10.200 and washer 10.210 to the intermediate plate.

**Warning: adjustment work is necessary (see item 1.4.8, Page 5/9)**

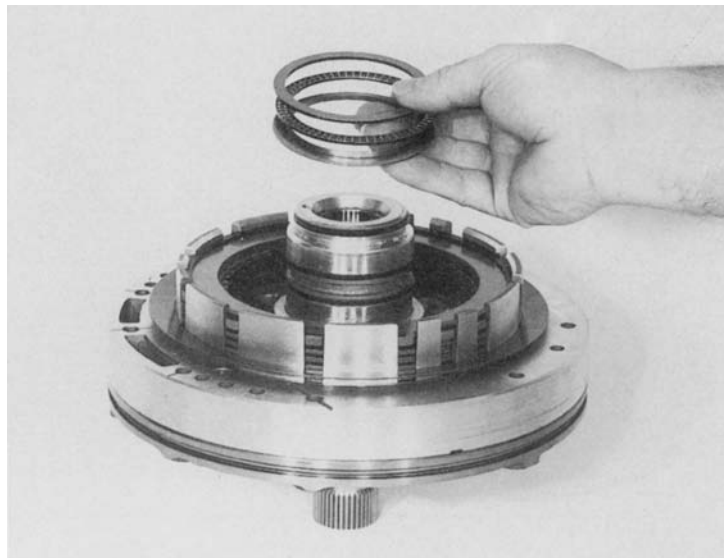

91 164

Place the 3rd gear freewheel on the hub of cylinder B.

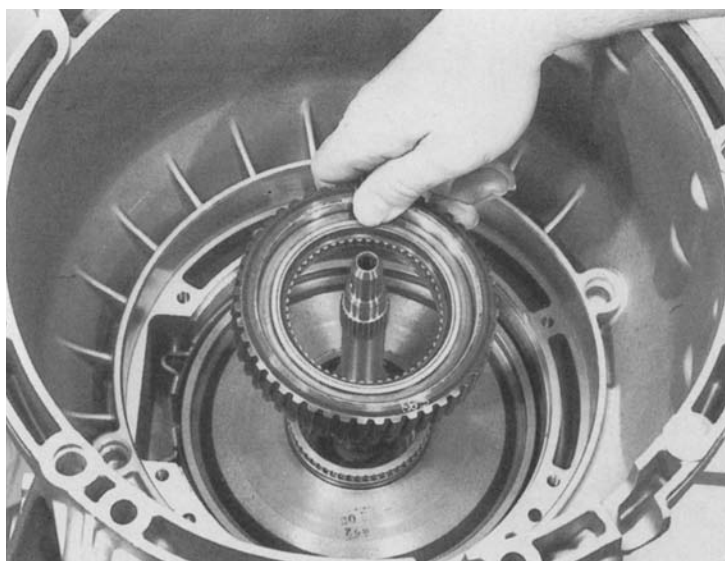

91 165

Pull O-ring 10.160 on to the pump, coat with ATF (automatic transmission fluid) and use assembly fixture 5 X 46 000 563 to insert the complete pump/intermediate plate assembly, turning this in either direction as it is inserted.

**Warning:**

This is a difficult assembly operation which must be performed with great care.

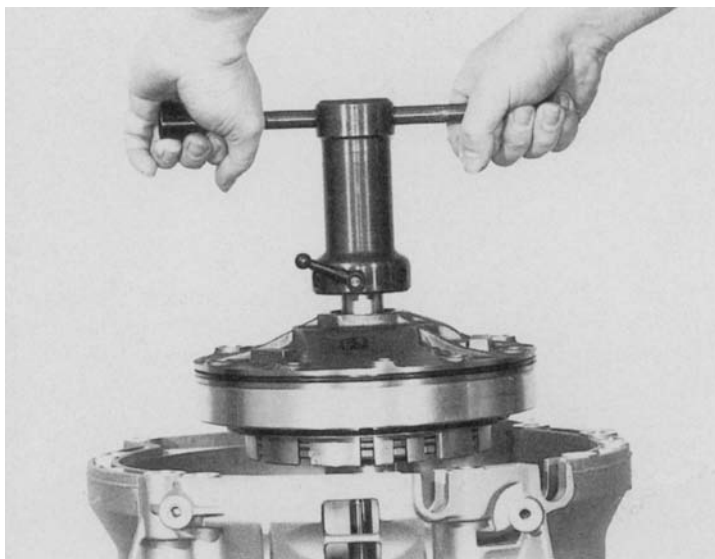

91 166

If correctly assembled, the complete unit makes spring contact with the housing. The turbine shaft projects approx. 62 mm beyond the stator shaft.

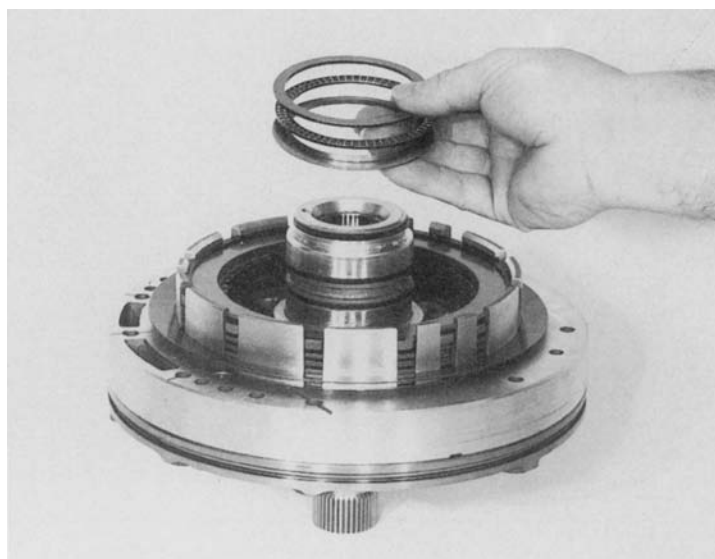

91 167

Tighten down with the 9 machine screws 10.230, using new Usit rings 10.220 on the screws.

(Wrench size = Torx socket wrench insert TX 27)

(Tightening torque = 10 Nm)

Check end play.

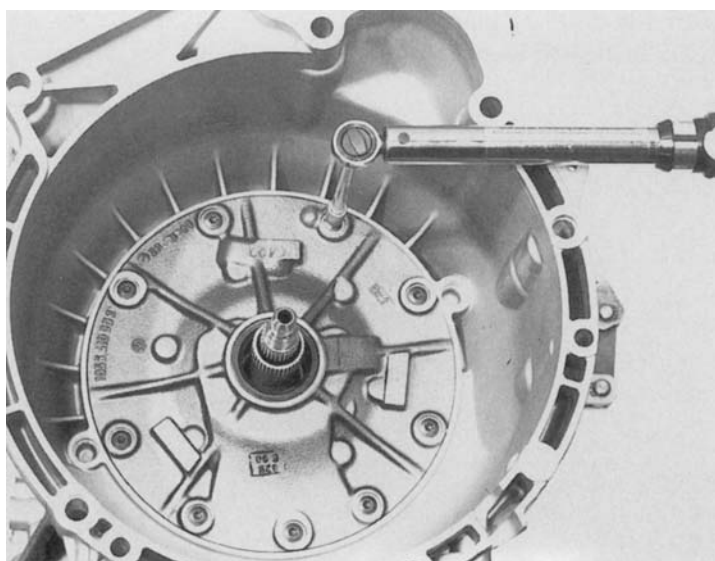

91 168

**Final assembly – Page 67**

Pre-assembly piston C<sup>2</sup> by installing the two diaphragm springs 75.030/120 and 75.030/130 with their convex sides against the shoulder on piston rod 75.030/110.

Slide piston 75.030/140 over this assembly and secure it with lock washer 75.030/160.

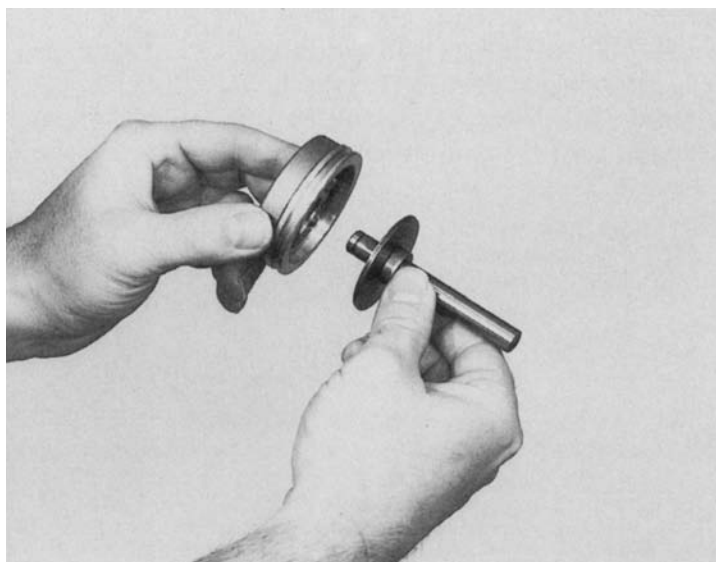

91 169

Pull O-ring 75.030/150 on to the piston and grease lightly (Vaseline). Place the two coil springs 75.030/170 and 75.030/180 over the piston rod.

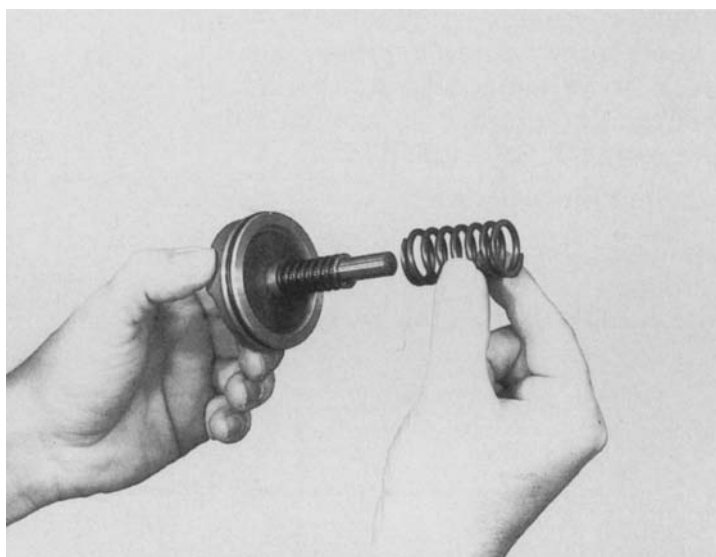

91 170

Place washer 75.034 (previously removed) in the transmission housing and insert piston C<sup>2</sup>.

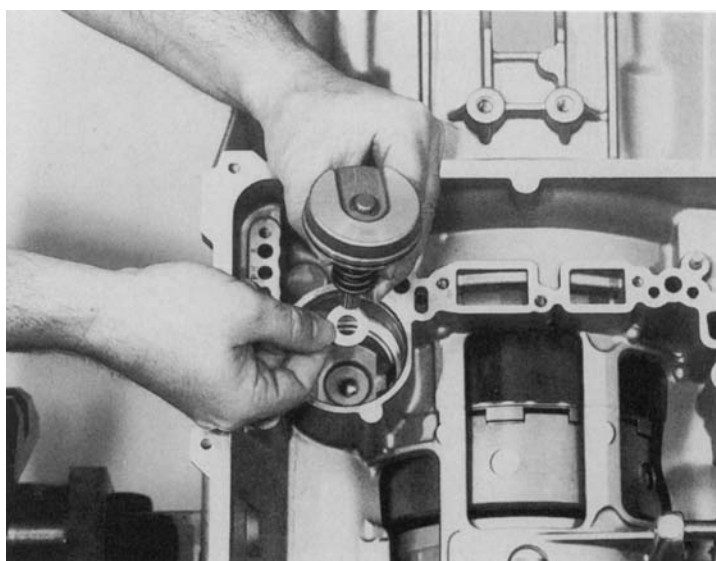

91 171

Pull O-ring 75.050/110 on to cover 75.050/100 and grease (with Vaseline). Place shim washer 75.040 (previously removed) in transmission housing and attach the cover.

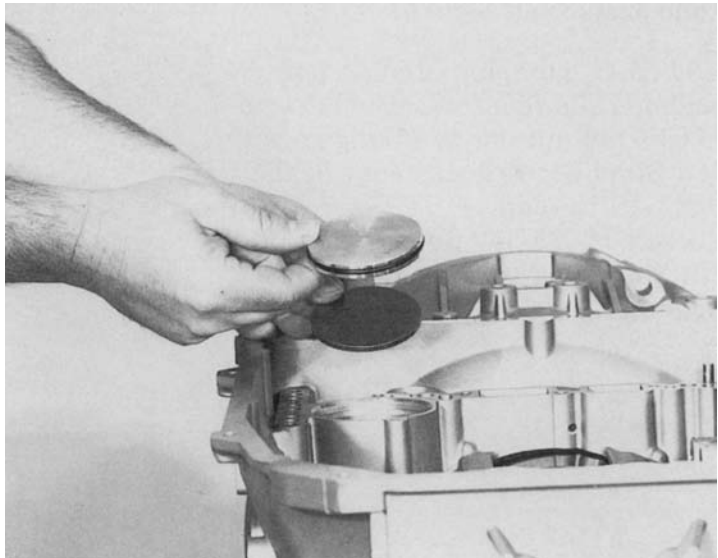

91 172

Bolt assembly fixture 5X46 000 574 to the transmission housing and use it to press the cover down. Insert snap ring 75.060 with a screwdriver.

**Warning: adjustment work is necessary.**  
The thickness of the washers must be determined. (see item 1.4.9, Page 5/11)

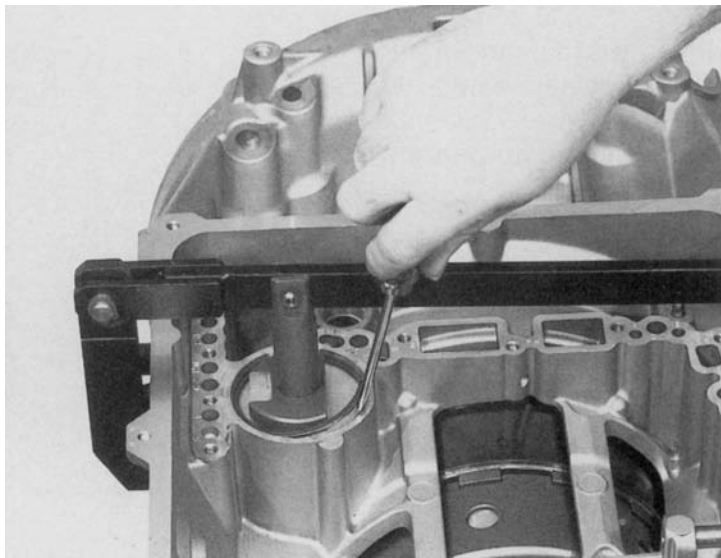

91 176

Next, insert the 3 screw plugs 01.060, using new sealing rings.

(Allen key size = 5 mm)  
(Tightening torque = 15 Nm)

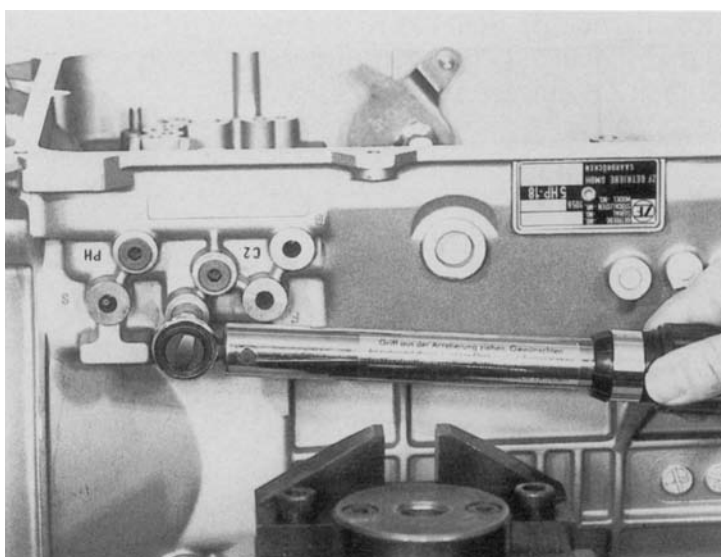

### 3.7 Selector unit, oil stump and converter

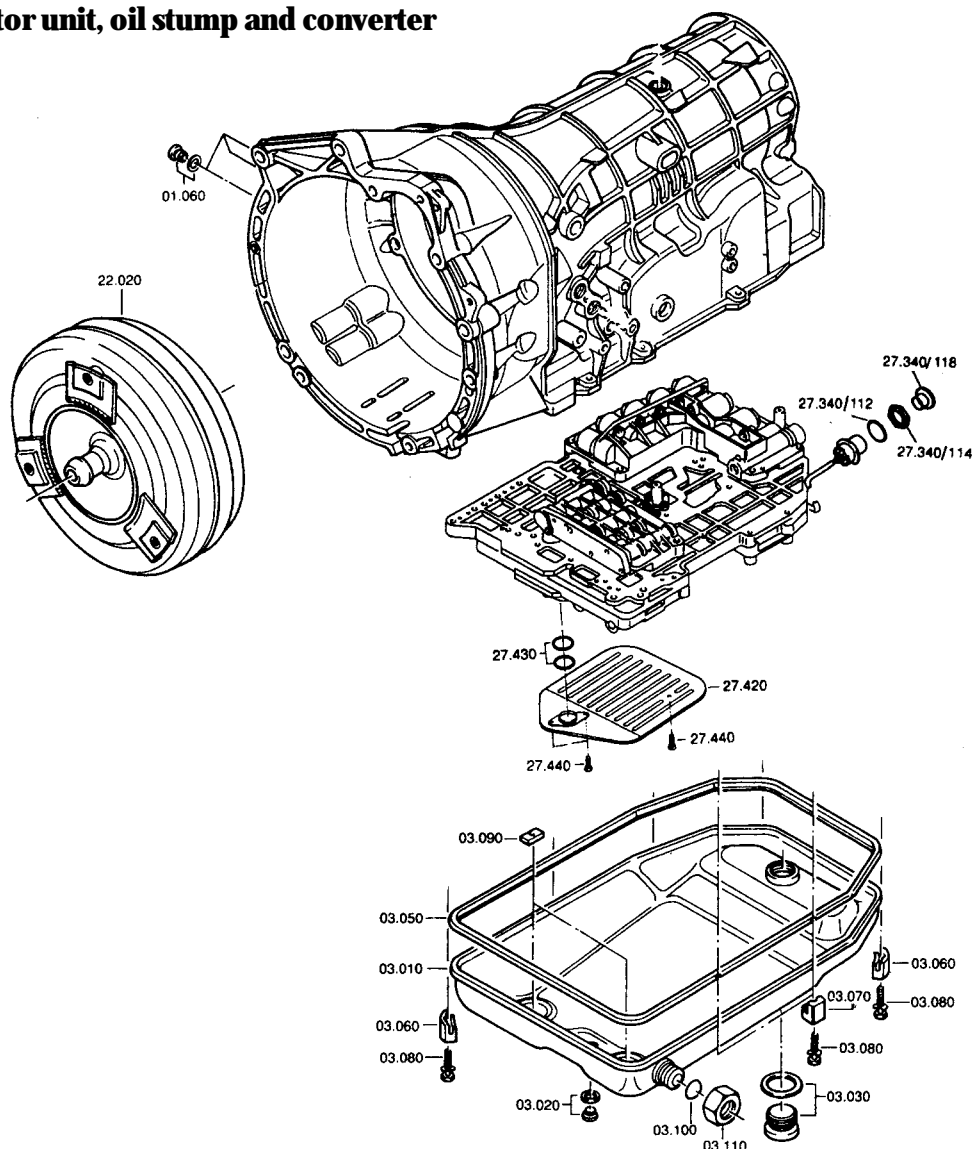

Before installing the selector unit you are recommended to check all clutches/brakes for leaks. To do this, inject compressed air at the oil feed bores.

91 177

Place the selector unit loosely in position.

Pull a new O-ring 27.340/112 on to the wiring harness socket and secure the wiring harness by tightening hex nut 27.340/114.

On older versions the flat chamfered face on the socket must be parallel with the wall of the transmission housing. Using a screwdriver, prevent the wiring harness from turning while it is being tightened.

(Wrench size = 32 mm)  
(Tightening torque = 20 Nm)

Attach dust cap 27.340/118.

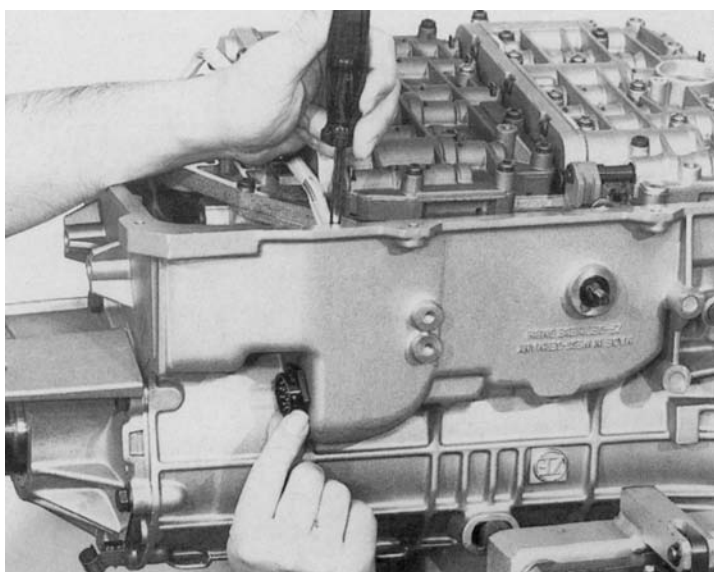

Offer up the selector unit at an angle, so that the pin of the detent disc can be engaged in the cutout on the shift valve.

Then lower the selector unit and locate it on the pin in the transmission housing.

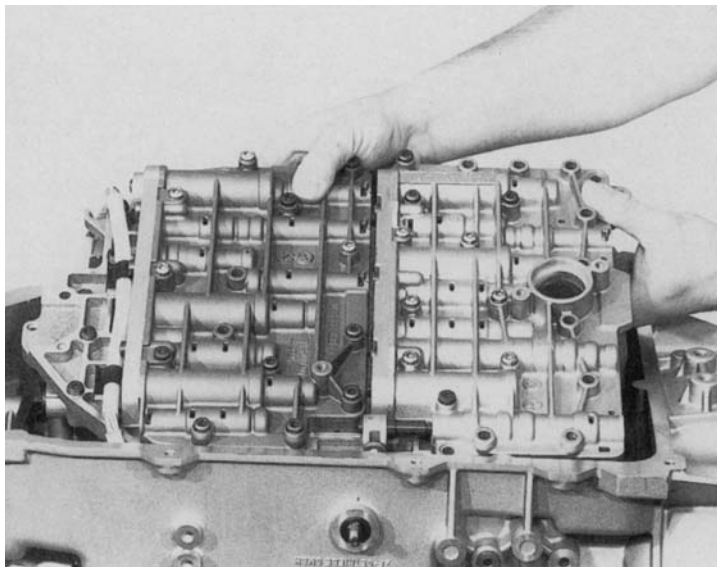

Secure the complete selector unit with the following machine screws:

Position	Quantity	Length (mm)	Tightening torque (Nm)
27.410	11	55	8
27.400	2	30	8

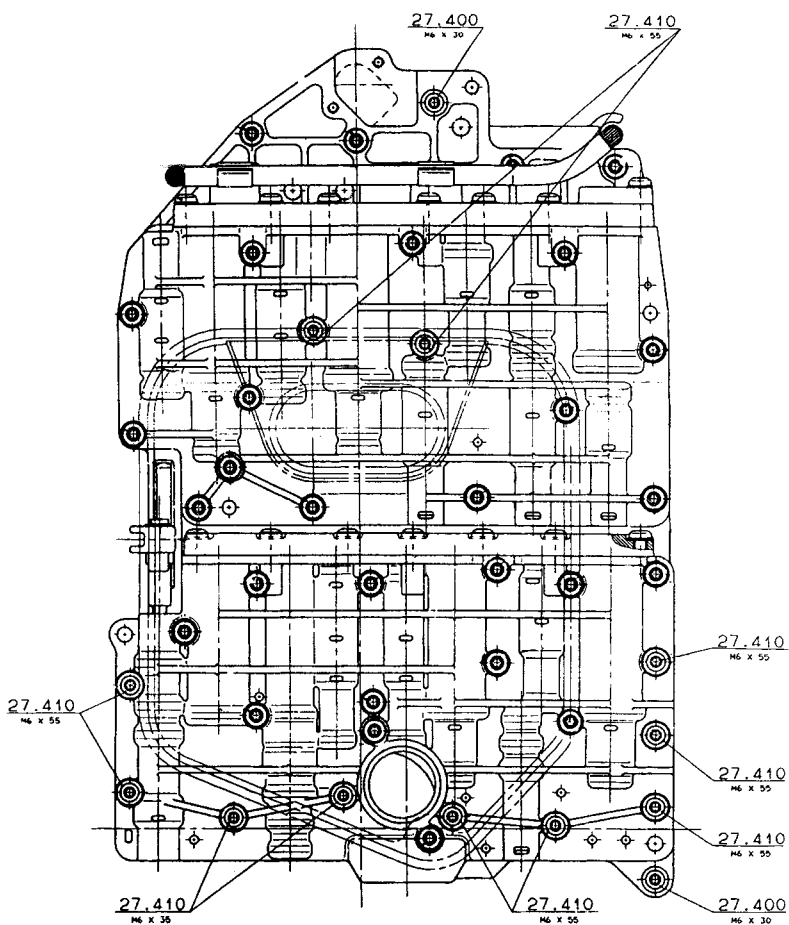

91 179

Also secure cover plate 27.460 with one of the machine screws 27.400.

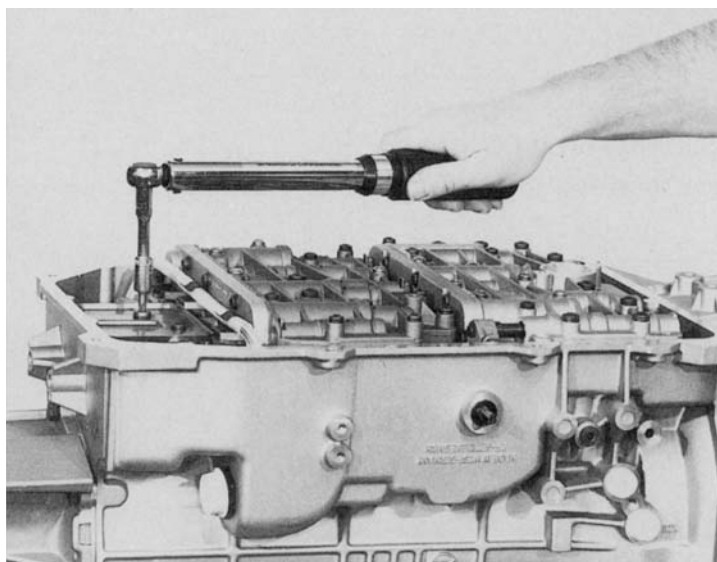

91 180

Pull two O-rings 27.430 on to the intake shoulder of filter 27.420. Secure the filter with 3 machine screws 27.440.

(Wrench size = Torx socket wrench insert TX 27)

(Tightening torque = 8 Nm)

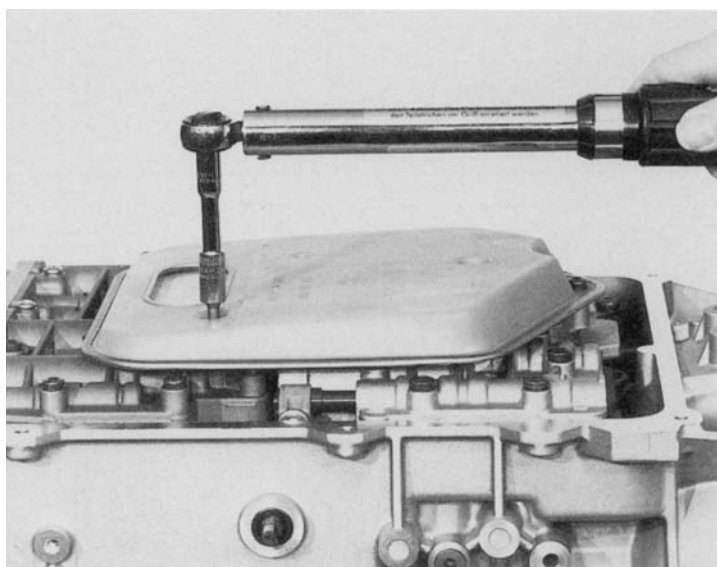

91 181

Insert 2 magnets 03.090 in the swaged recesses of oil sump 03.010.

Attach gasket 03.050 to the edge of the oil sump.

If necessary, install screw plugs 03.020 and 03.030 with new sealing rings and end cap 03.100 with collar nut 03.110.

Various patterns are in use (with and without connection for oil dipstick).

(For tightening torques, see Page 6.)

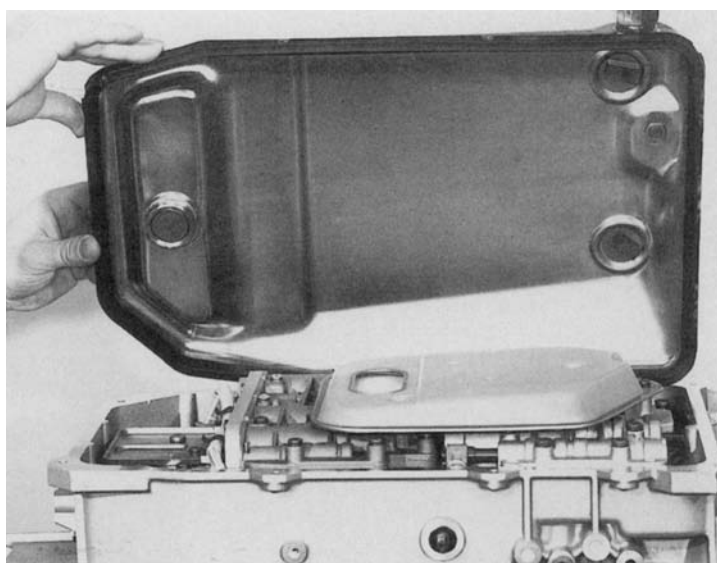

91 182

Attach the oil sump to the transmission housing, using 5 retaining angles 03.070 and 3 retaining angles 03.060. Secure with 8 hex bolts 03.080.

(Wrench size = 10 mm)

(Tightening torque = 10 Nm)

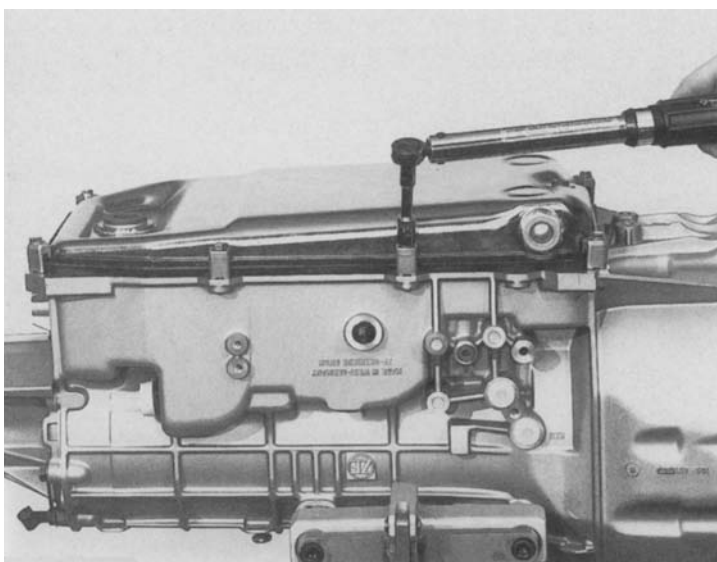

91 183

Screw in two handles 5 X 56 000 090 into converter 22.020 and insert it carefully.

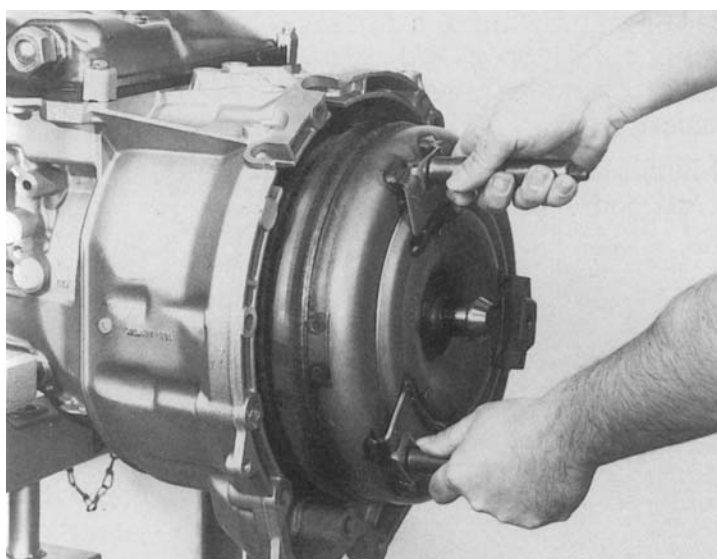

91 184

Turn the transmission through 90 degrees. Turn the converter in either direction until the pump drive journals have engaged.

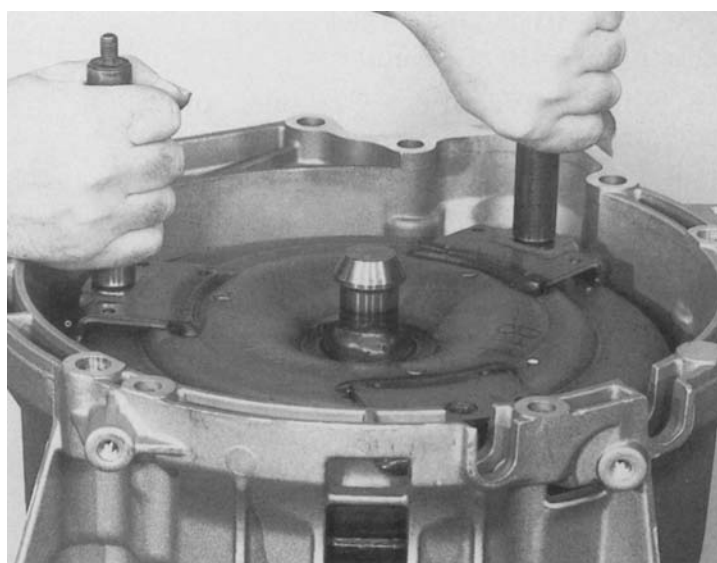



**Place plug 06.100 on the selector shaft  
and bolt on the converter retaining hoop.**

