



# Installation and Operation Manual for 4R70W Transmissions

US Shift Transmission Control System (TCS) instruction and operation manual.

Baumann Electronic Controls, LLC.

207 Mistr Lane, Pickens, SC 29671

Phone: (864) 646-8920 FAX: (864) 335-9055

This work, and the ideas and processes contained herein are the exclusive property of **Baumann Electronic Controls, LLC**, and may not be copied, reproduced or distributed in any form without the express written consent of **Baumann Electronic Controls, LLC** or Karl Baumann. The technology and processes contained in this product are proprietary and may be used only on a single unit basis or as defined by the written permission of **Baumann Electronic Controls, LLC**.

V4.3 © Copyright 1997 - 2011 by Baumann Electronic Controls, LLC.

All rights reserved.

#### **WARRANTY:**

**Baumann Electronic Controls, LLC. is dedicated to producing the highest quality products available in the industry and is committed to customer satisfaction. Because we have no control over the circumstances under which our products are used, we can assume no more responsibility for damages (consequential or otherwise) or defects in materials and workmanship than the original purchase price of our product. Baumann Electronic Controls, LLC. will repair or replace all defective components unconditionally for a period of five years from the date of sale. This Warranty does not cover damages due to abuse or improper application or connection of the device. After the Warranty period, Baumann Electronic Controls, LLC. will service this device for a nominal fee.**

#### **APPLICATION COVERAGE**

This system works with all 4R70W/4R75/AOD-E automatic transmissions. It is recommended that you use the Baumann wiring harness with this system.

## **CONTENTS**

<b>Preparation</b>	<b>Page 4</b>
<b>Connecting the Essentials (EFI)</b>	<b>Page 5</b>
<b>Connecting the Essentials (CARB)</b>	<b>Page 6</b>
<b>Setting up the Quick 1</b>	<b>Page 8</b>
<b>Notes on Installation</b>	<b>Page 10</b>
<b>Transmission Diagrams</b>	<b>Page 12</b>
<b>Optional Accessories</b>	<b>Page 15</b>
<b>Manual Shift Connections</b>	
Overview	Page 17
Manutronic Jumper	Page 17
Ford Cruise Buttons	Page 18
Without Cruise Module	Page 19
Push-buttons + On/Off Toggle	Page 20
Push-buttons + On/Off Push-button	Page 21
Shrifter™ Receiver	Page 22
<b>Shiftware</b>	
Introduction	Page 23
Setup	Page 23
Customize	Page 24
Tables	Page 25
Save & Load	Page 25
Writing a Calibration	Page 25
<b>Important Information</b>	<b>Page 26</b>
<b>Troubleshooting</b>	<b>Page 27</b>
<b>Contact</b>	<b>Page 27</b>

### **READ BEFORE PROCEEDING**

Before installing the Quick 1 unit, we recommend you read the manual from beginning to end. Some of the information in this manual is very important and, if the unit is improperly installed or an error code misunderstood, could result in serious damage to your vehicle and transmission.

## **PREPARATION**

### **Pre-1996 Transmissions:**

Before installing the Quick 1 unit, make sure that the transmission has a high-impedance (~10 Ohms) torque converter clutch solenoid. A low-impedance solenoid will cause damage to the Quick 1 due to excessive current draw and should never be used. If the transmission is from 1992-94, it will have a 1 Ohm low-impedance solenoid. All 1995 transmissions use this low-impedance solenoid except for the LTD, Grand Marquis, and Town Car. All 1996 and later transmissions use the proper high-impedance solenoid and do not need to be changed.

To check which solenoid you have, remove the pan and check the part number prefix on the solenoid. The right solenoid (High) will have "F5AP" or later prefix. The wrong solenoid (Low) will have a "F2VP" prefix. You can also check the solenoid with an ohmmeter by connecting the transmission harness to the bulkhead. Set the meter to the 1X range and connect to +12V (Red wire) and the negative Converter Clutch Solenoid (either Brown/Orange or Purple/Yellow). The right solenoid will read ~10Ω, while the wrong solenoid will read ~1Ω. If you have the wrong solenoid, you can order the right one from Ford. (Part #F5AZ-7G136-A)

### **All Transmissions:**

For performance or heavy-duty use, the valve body calibration should be modified to increase transmission torque capacity. Though the transmission is electronically controlled, the valve body still controls full-throttle shift firmness and the ultimate torque-capacity of the transmission. Baumann Electronic Controls offers valve body recalibration kits with five levels of shift firmness, allowing for precise calibration to meet the vehicle's needs.

**CONNECTING THE ESSENTIALS**  
**(ELECTRONIC FUEL INJECTION)**

**Step 1: Ground**

Splice the ground wires (Pins 15 & 16 Black) from the Quick 1 into the main ECU (Engine Control Unit) ground wire. Do NOT connect the ground wires to sheet metal or other ground sources. The Quick 1 MUST be connected to the Main ECU ground, as close to the ECU as possible.

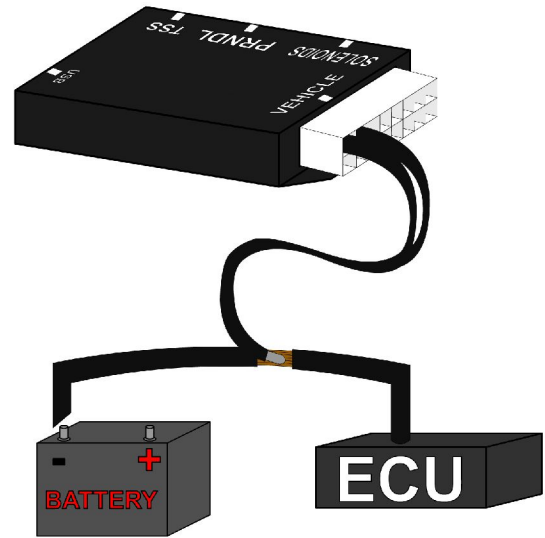
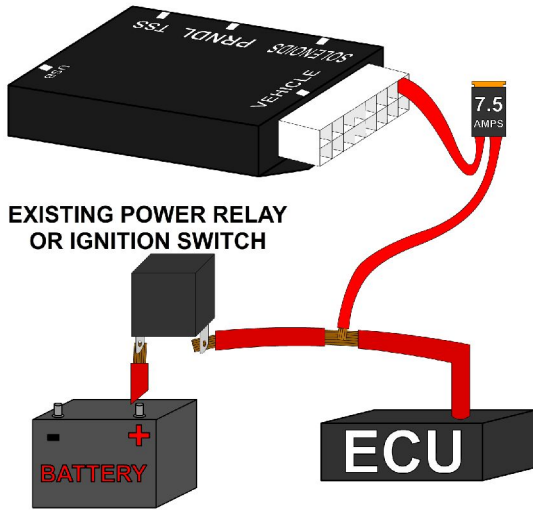

**Step 2: Power**

Splice the power wire (Pin 9 Red with 7.5 Amp fuse) from the Quick 1 into the main ECU (Engine Control Unit) ignition-switched power wire.

**Step 3: Throttle Position Sensor or Accelerator Pedal Position Sensor**

Splice the Throttle Position Sensor signal wire (Pin 3 Green) from the Quick 1 into the Throttle Position Sensor (TPS) signal input of the ECU (Engine Control Unit). If the vehicle has Electronic Throttle Control, use the Accelerator Pedal Position (APP) Sensor instead of the TPS.

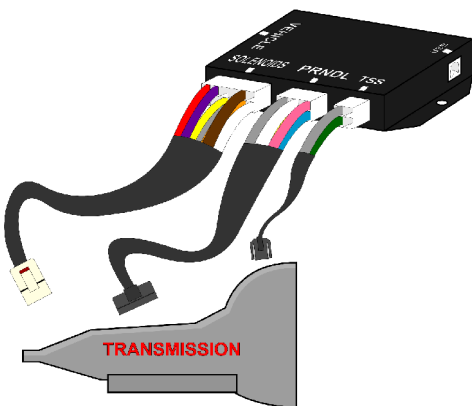
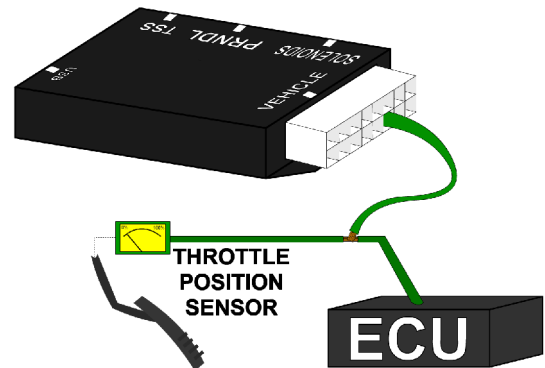

**Step 4: Transmission Connectors**

Connect the Solenoid, PRNDL, and TSS cables to the transmission. Additionally, connect the Neutral Safety Switch and the Backup Lamp Switch.

**Step 5: Accessories**

Connect the optional accessories you wish to use. See the "Optional Accessories" section for details.

## CONNECTING THE ESSENTIALS (CARBURETED AND MECHANICALLY-INJECTED DIESEL)

### Step 1: Ground

Connect the ground wire (Pin 15 Black) from the Quick 1 directly to the battery ground post or negative battery cable. Do NOT connect the ground wire to sheet metal or other ground sources. The Quick 1 MUST be connected directly to the battery ground post or negative battery cable.

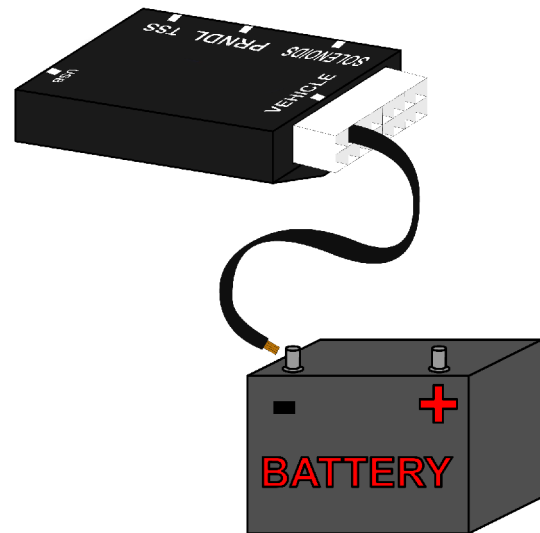
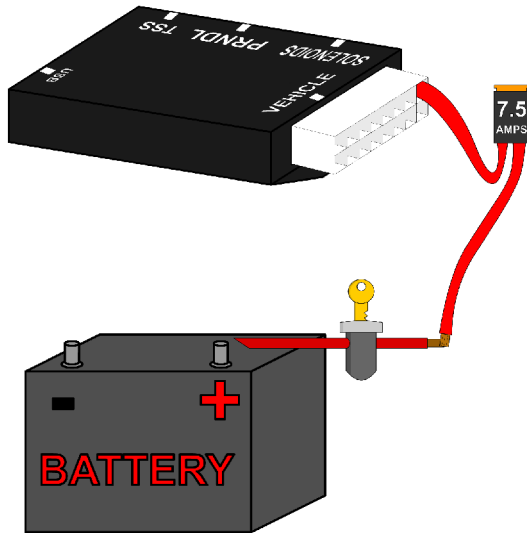

### Step 2: Power

Connect the power wire (Pin 9 Red with 7.5 Amp fuse) from the Quick 1 to ignition-switched power wire. Do NOT use accessory-switched power.

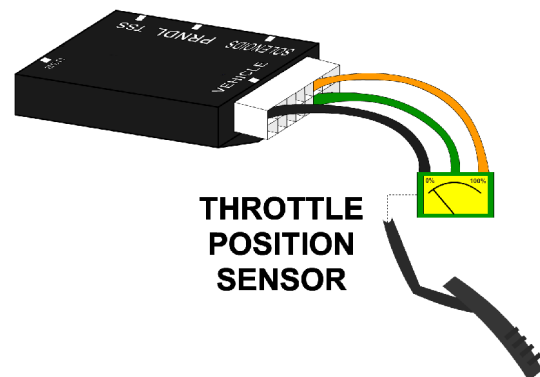

### Step 3: Throttle Position Sensor

Attach the 3 Throttle Position wires from the Quick 1 to the Throttle Position Sensor. Pin 16 Black is dedicated ground. Pin 11 Orange is +5v reference feed. Pin 3 Dark Green is the position sensor signal. See the "Throttle Position Sensor" section for details.

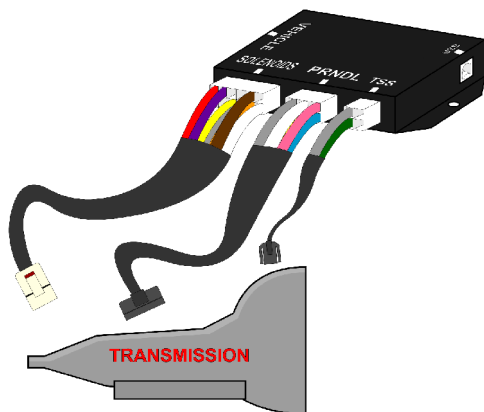

**Step 4: Transmission Connectors**  
Connect the Solenoid, PRNDL, and TSS cables to the transmission. Additionally, connect the Neutral Safety Switch and the Backup Lamp Switch.

### Step 5: Accessories

Connect the optional accessories you wish to use. See the "Optional Accessories" section for details.

## Basic Vehicle Connections Electronic Fuel Injection

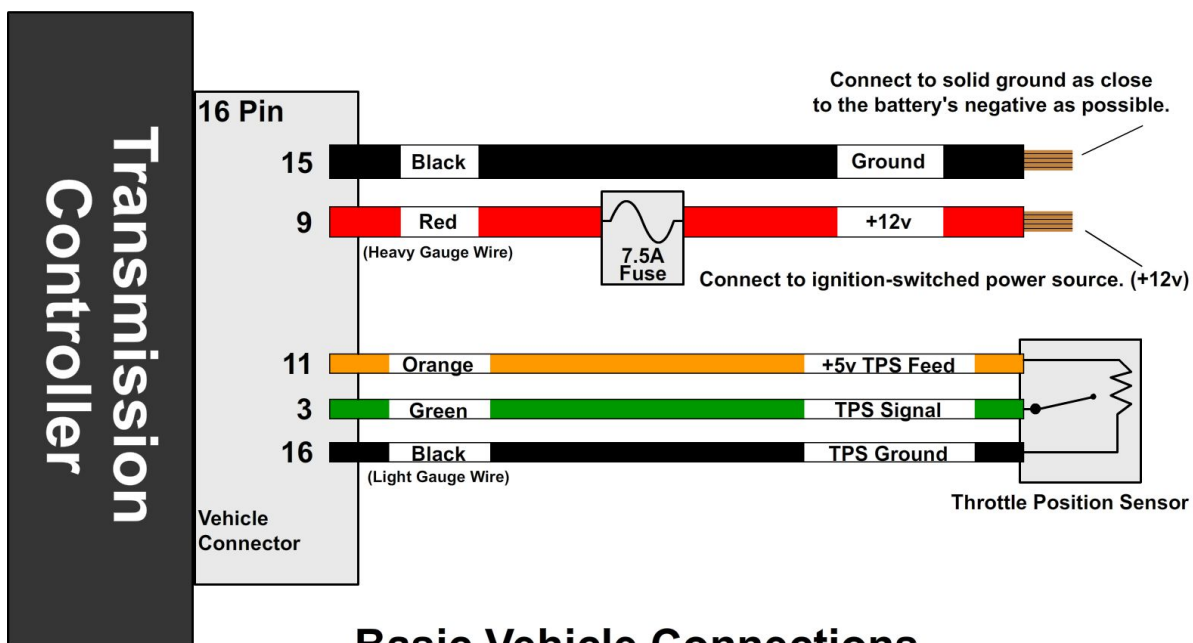
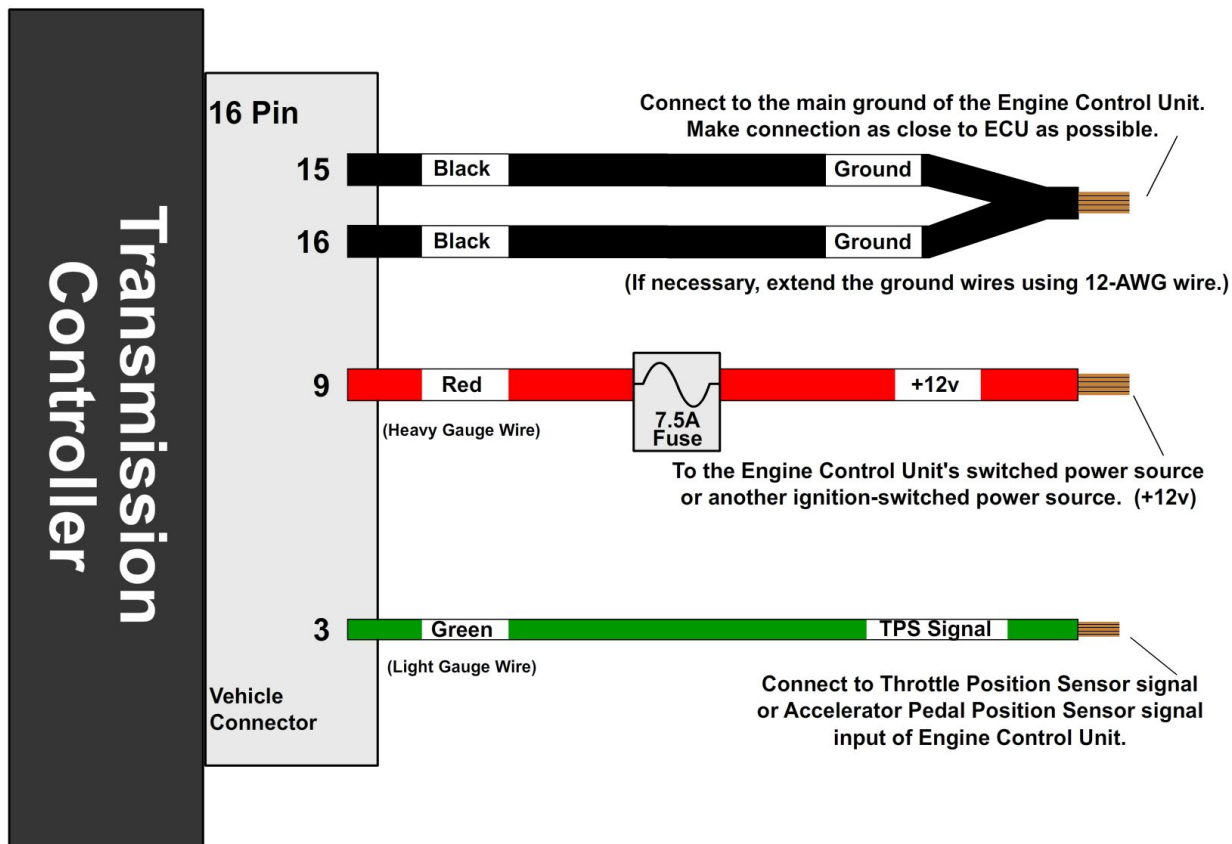

## Basic Vehicle Connections Carbureted and Mechanically-Injected Diesel Applications

## SETTING UP THE QUICK 1

### Step 6: Calibration

Verify that the correct calibration is loaded on the Quick 1. A standard calibration specific to your order is loaded before shipment. However, if the transmission configuration has changed since the order was placed, you'll need to connect the Quick 1 to a Windows PC and install the Shiftware Tuning Software. (See the "Shiftware" section for installation instructions.) Using the software, load the calibration that matches your transmission's configuration.

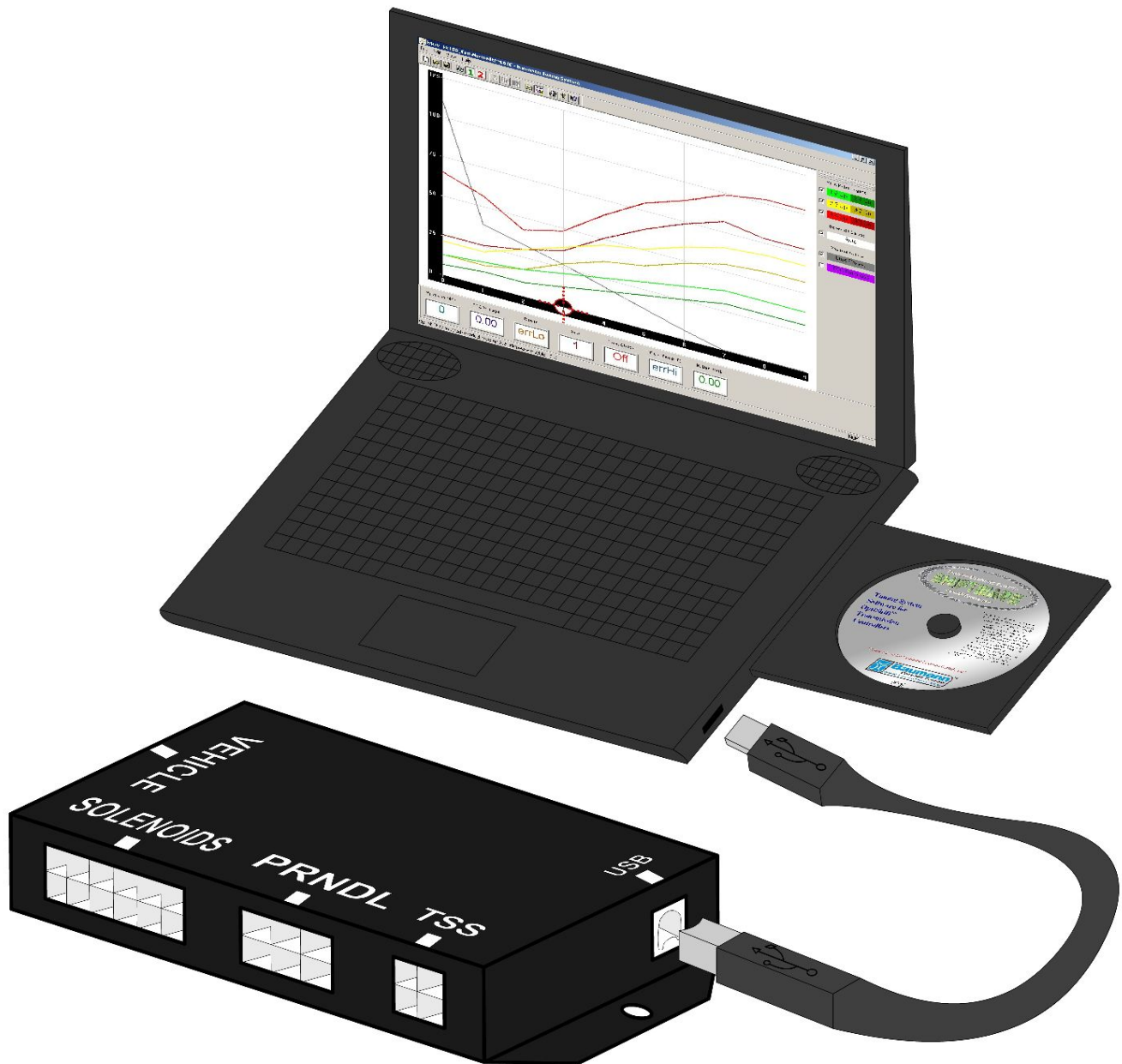



**Step 7: Throttle Position Sensor Calibration**

Set the Closed Throttle and Full Throttle Positions. This step should be done with the ignition turned to “ON”, but the engine off. The engine should also be warm.

Turn the knob to “Tune” (tnE) and click once. “Closed Throttle Position” (CtP) should be displayed. Leave the accelerator untouched. Click the knob once, then double-click to set the current Closed Throttle Position. Click again to exit.

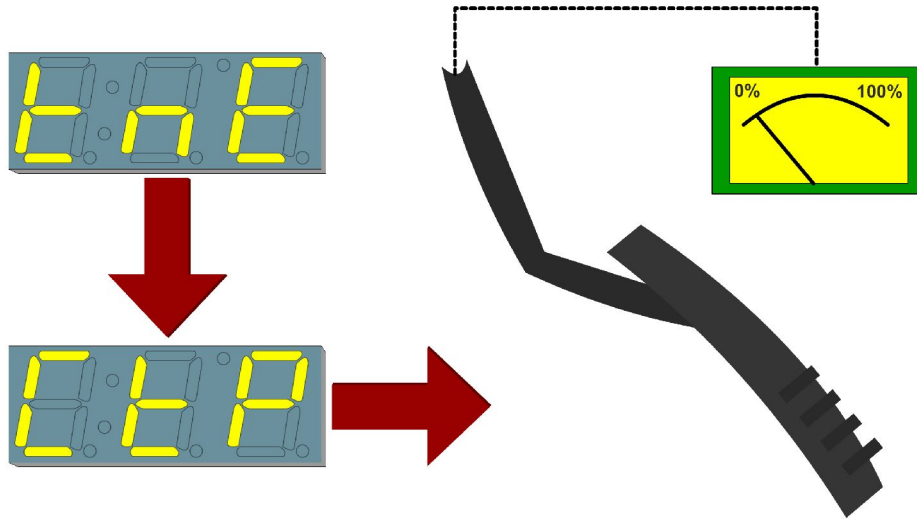

Turn the knob to “Full Throttle Position” (FtP). Hold the accelerator all the way down. Click the knob once, then double-click to set the current Full Throttle Position. Click again to exit.

Turn the knob to “Save and Exit” (SAE). Click once to save and exit.

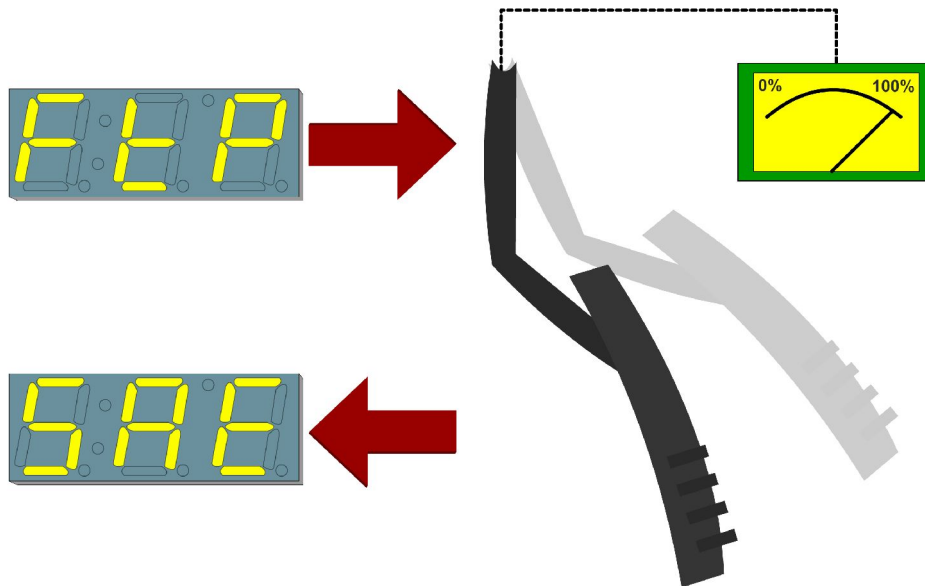

## **NOTES ON INSTALLATION**

### **General Installation:**

The Quick 1 unit should be mounted within the passenger compartment of the vehicle in a protected location. Good mounting areas include under the dash, behind a kick panel, or under the seat, as long as the unit and wiring are not subject to damage. Under-hood mounting is **NOT** possible with the Quick 1 unit. It is not waterproof or rated for under-hood temperatures. Passenger compartment mounting is also necessary to provide easy access to the USB port, which is used to interface with a PC for programming and diagnostics, as well as the display and function control knob. For this reason, be sure to mount the unit in a way that gives easy access to the USB port, knob, and display. If you will be using a desktop PC for programming, install the unit so that it can be unplugged and moved easily.

All electrical connections should be made using 60/40 rosin core solder. Cover the connection with heat-shrinkable tubing for improved insulation and mechanical strength. Individual connector terminals can be connected using a “piggy-back” method, where the terminal is removed from the plastic connector housing to allow the new wire to be soldered on to the terminal atop the original wire. Two wires may be connected together by twisting them together longitudinally, soldering, then covering with the appropriate size heat-shrink tubing.

### **Before Driving the Vehicle:**

Start the engine and move the shifter through all positions, ensuring that the gear position and all sensor readings shown on the controller are correct. Most importantly, make sure that no error codes are shown on the Quick 1 display. It is a good idea to periodically check the Quick 1 display for errors as you drive, so it is wise to consider an accessible mounting location. If any error codes or unexpected characters are displayed, please refer to the user interface manual for detailed explanations. If possible, perform a line pressure check to ensure that line pressure is correct at idle (typically 60 - 80PSI), and that it smoothly increases toward maximum (typically 190-240PSI) as the throttle position increases. If you have any questions about the installation or line pressure readings, please contact our technical support department.

**Adaptation for Factory-Equipped Transmissions:**

It is possible to use the Quick 1 TCS in a vehicle which was originally equipped with one of the intended transmissions. This could be done in conjunction with an engine management system upgrade that no longer supports the transmission. Use of the TCS for this purpose allows flexibility in choosing the engine management system, in addition to the increased control, performance, and transmission durability afforded by Quick 1. If you retain the stock PCM/VCM, it can probably be modified or re-flashed to disable the transmission functionality.

**Identifying the Terminals of an Unknown Throttle Position Sensor:**

This is a procedure for identifying the correct terminal connections of any potentiometer-style throttle position sensor (almost all three-terminal TP sensors). A DVOM or analog Ohmmeter is required.

**1.** Set the meter to resistance mode and set it to a scale that can read up to 10K or 20K Ohms (if it is not auto-ranging). Please keep in mind when setting up and reading the meter that "K" means thousands of Ohms. In other words, 15K Ohms is the same as 15,000 Ohms.

**2.** Connect the meter to two pins at a time while operating the lever or cam of the TPS. Watch the meter while rotating the sensor. Check all three pairs of pins until you find a pair that does not change resistance when you rotate the sensor. The two pins that do not change resistance are the fixed ends of the resistance element (+5V and ground). The remaining pin that did change is known as the "wiper". It is the moving contact that slides along the resistance element to give the varying voltage. This is the output terminal of the sensor and should be connected to our green wire (Vehicle pin 3).

**3.** Next, with the sensor at the idle or closed throttle position, measure the resistance between the wiper (output) and each of the end terminals (the two whose resistance did not change in step 2) of the sensor. The end terminal with the lowest resistance to the wiper (at idle) is the ground terminal, and should connect to the black main ground wire of the TCS (Vehicle pin 16). The terminal with the higher resistance to the wiper is the 5 volt reference input to the sensor and should connect to the orange wire (Vehicle pin 11) in our harness.

**General Guidelines for setting up Throttle Position Sensors:**

The linkage to a throttle position sensor should use most of the rotating range of the throttle position sensor. This can be adjusted by changing the ratio of the linkage. Also, please make sure that a small amount of the sensor's travel is being used at idle. You will want a TPS voltage at idle of at least 0.35 volts. This is done to allow the TCS to detect problems with the TP sensor. For instance, if the sensor becomes disconnected or the linkage falls off, the TPS voltage will fall below the set idle threshold. If the TPS voltage goes below the idle threshold, the TCS assumes that the TPS is bad and will switch to failsafe line pressure and default shift points. This is done to prevent damage to the transmission from low line pressure and will provide a safe "limp home" mode.

**TRANSMISSION DIAGRAMS**

**Early 4R70W**

1992-1997

**Solenoid Connector**  
(White Transmission Connector)

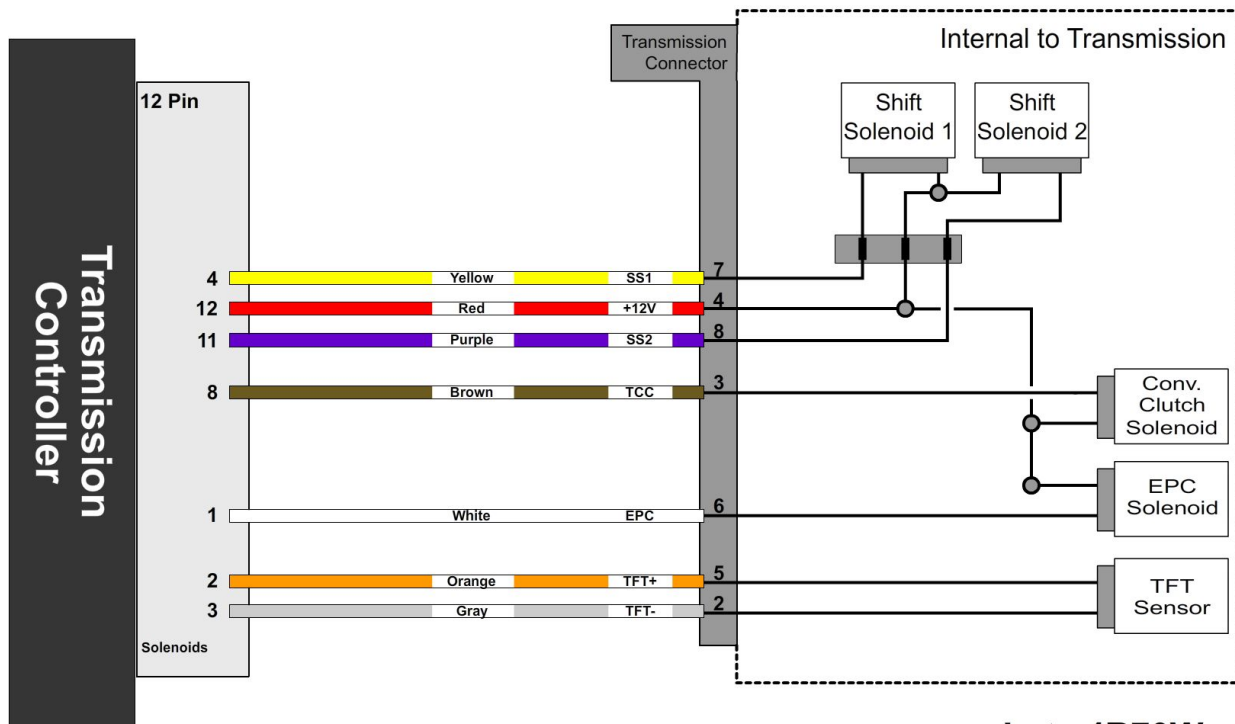
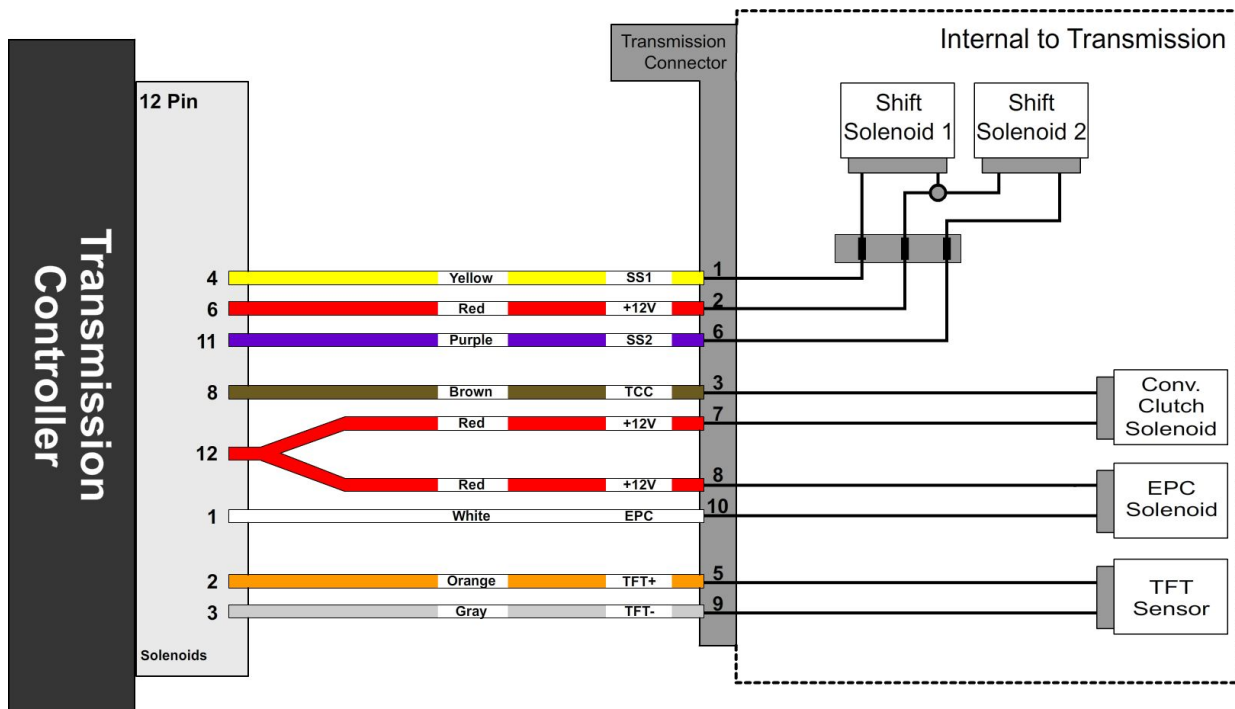

**Late 4R70W**

1998+

**Solenoid Connector**  
(Black Transmission Connector)

### Speed Sensor

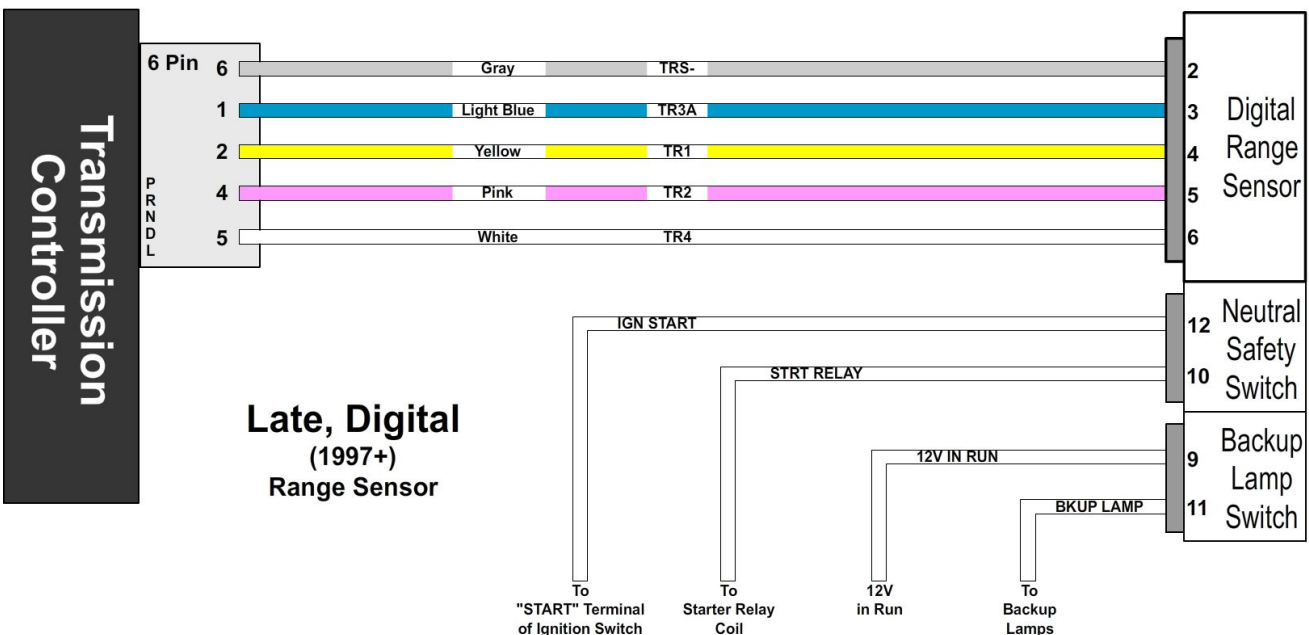
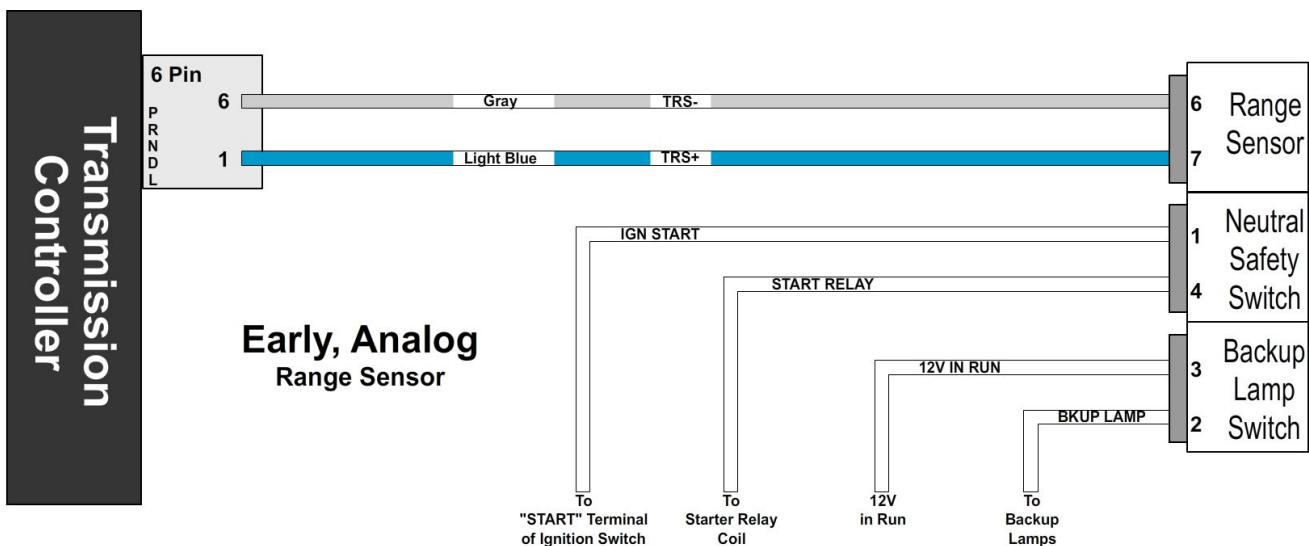
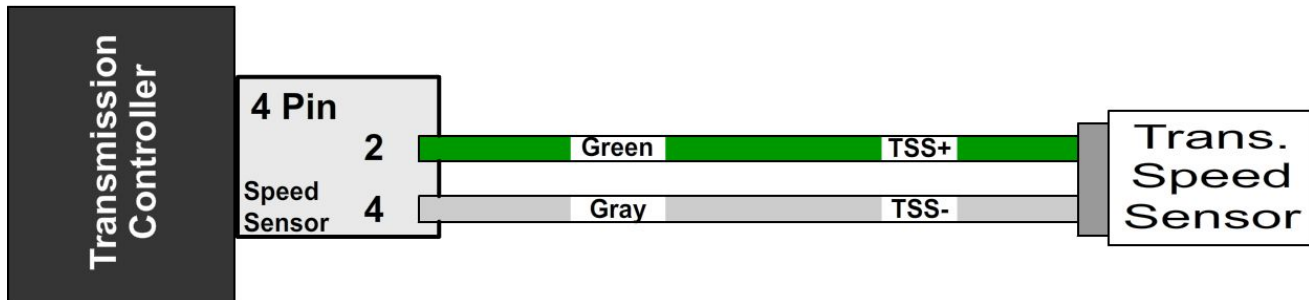

**Early 4R70W**

BACK VIEW  
(FRONT PLUGS IN, WIRES COME OUT OF THE BACK)

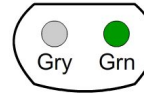
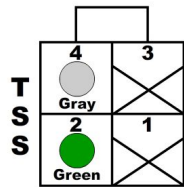
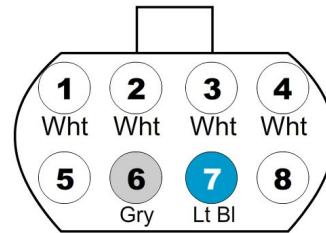
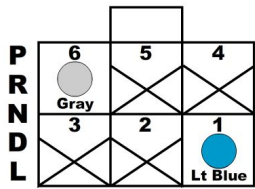
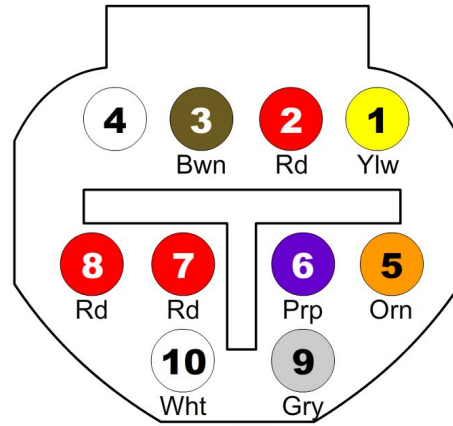
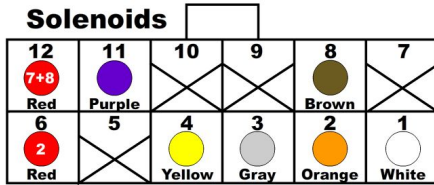

**Late 4R70W**

BACK VIEW  
(FRONT PLUGS IN, WIRES COME OUT OF THE BACK)

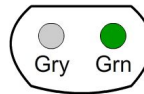
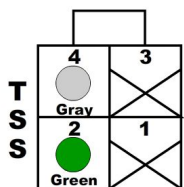
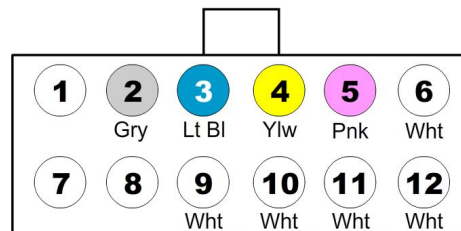
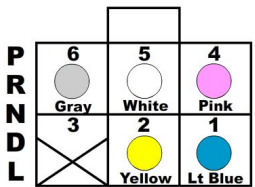
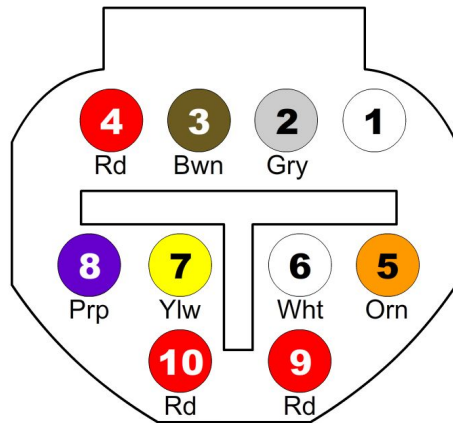
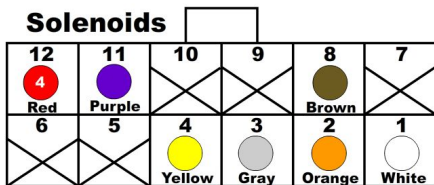

## OPTIONAL ACCESSORIES

### **Table Select:**

The table selection switch should be an On-Off type switch (such as a toggle or latching push-button switch) which applies ground to the table select input at Vehicle connector pin 5 when turned on. When the switch is turned on, the TCS will use the secondary calibration tables, allowing a completely different calibration to be selected for the transmission at any time. The Table Selection input may also be connected to a nitrous oxide system to provide an alternate calibration for use when the nitrous system is engaged. Other uses for this input include a "Sport/Economy" switch or a "Normal/Aggressive" switch. The usefulness of this input is limited only by your imagination.

### **Speedometer Output:**

We have provided an adjustable speed signal output that can be used to drive an electronic speedometer, if desired. Use of this output signal is not necessary, but it can be helpful if your speedometer can not be driven correctly from another source. This signal can also be corrected for different gear ratios and tire heights, so it can be very useful in some applications. The speedometer output signal is normally provided as a 5 Volt square wave, but it can also be configured to provide a 12 Volt square wave when required (please refer to the "jumper settings" document for more information).

There are two speedometer output modes that can be selected via the tuning software or the built-in tuning interface. It can also be disabled if not used. In the replicated speed sensor output mode, the speedometer output provides an amplified and squared version of the original speed sensor signal. Replicated mode is useful for applications that require a signal with the exact pulse rate of the speed sensor being used. There is also an adjustable corrected mode, which is very useful for correcting speedometer errors, or providing unusual speedometer output signal frequencies.

Adjustable mode is essentially the electronic equivalent of a ratio corrector gear box for a mechanical speedometer. In adjustable mode, the correction factor is entered as a decimal number. The correction factor is the frequency ratio of the speedometer output frequency to the speed sensor frequency. This number can be easily adjusted to synchronize the vehicle speedometer to a GPS or other instrument.

In some cases, such as driving the input of an engine control ECU, the 0-5 Volt (or 0-12 Volt) square wave signal will not be able to properly drive the device that it is connected to. This is because some devices are only designed to accept an input signal from a variable reluctance (magnetic coil) sensor. Because of this, they may expect the input signal to swing below ground (0 Volts). To drive this type of input, an external capacitor can be used to "offset" the DC value of the speedometer signal to 0 Volts. As a result, the driven device will see a -2.5V to +2.5V signal, instead of 0V to 5V. To make this signal work, simply install a 10  $\mu$ F or larger, non-polar capacitor inline between the speedometer output of Quick 1 and the device that it is driving. A non-polar electrolytic capacitor (commonly used for speaker crossovers), with a rating of 25 Volts or higher can be used, and is readily available at most electronics supply stores. To install the capacitor, simply cut the speedometer output wire and solder a capacitor lead to each of the two cut wires.

### Accessory Connections

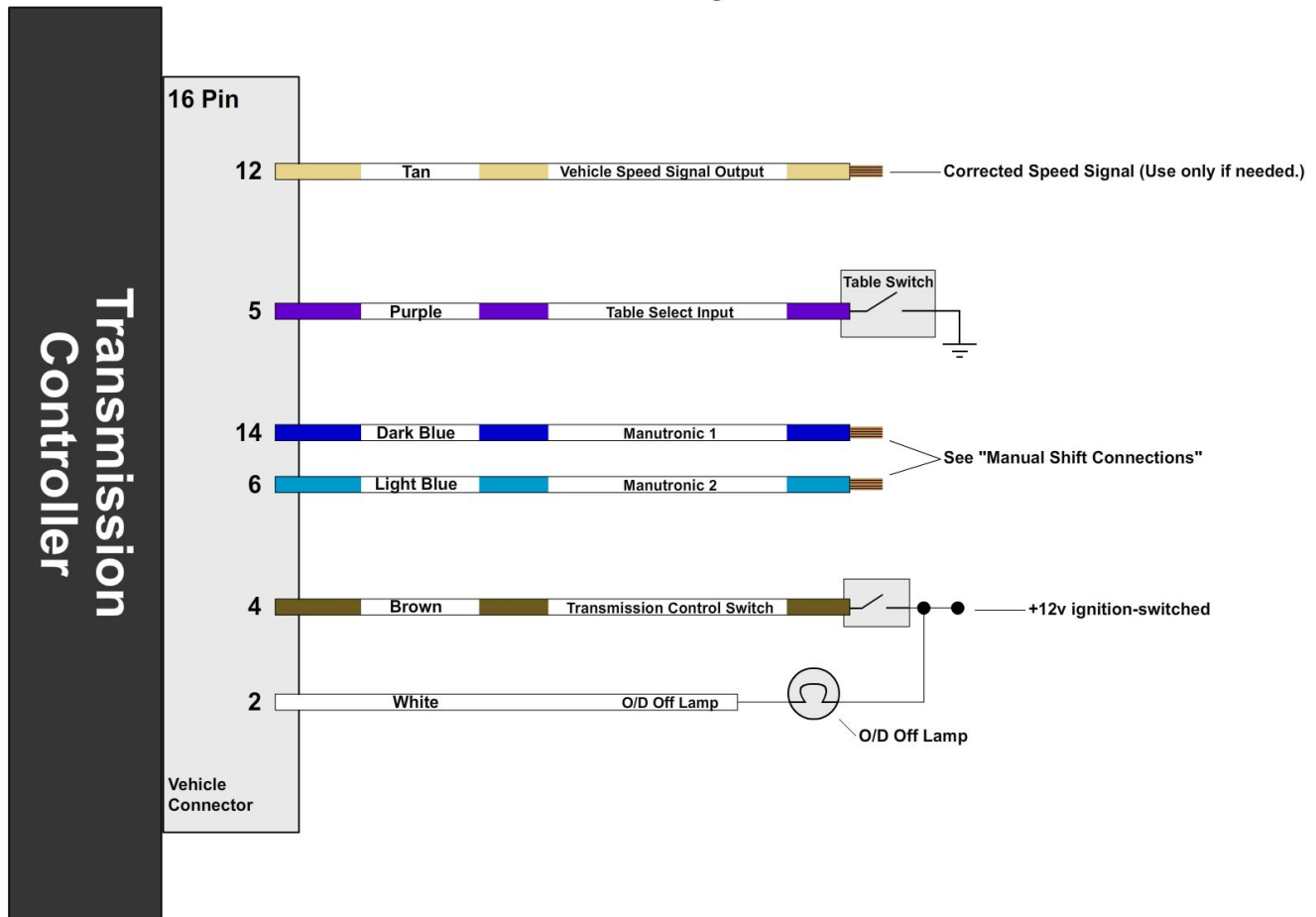



## Manual Shift Connections

### Manutronic Overview:

If connected and enabled in the software, the ManuTronic feature will allow manual selection of all forward gears using paddles, push-buttons, or another type of switch. With ManuTronic engaged, a brief press of the **UPSHIFT** button will change to the next higher gear, while **DOWNSHIFT** will change to the next lower gear. ManuTronic also has a safety feature which inhibits downshifting if the engine RPM is too high, which prevents over-revving of the engine due to a driver's error.

### Manutronic Reference Supply (JW2-5)

There are several different ways to configure the Manutronic to meet your specific needs. Depending on your Manutronic configuration, you may need to install or uninstall the Manutronic jumper (JW2-5). You can find the jumper settings manual on the Quick 1 software disc in PDF format.

This jumper supplies 5V to the Manutronic 1 input and should be installed for all Manutronic configurations (except for a Ford cruise control system). See the sections below for further explanation.

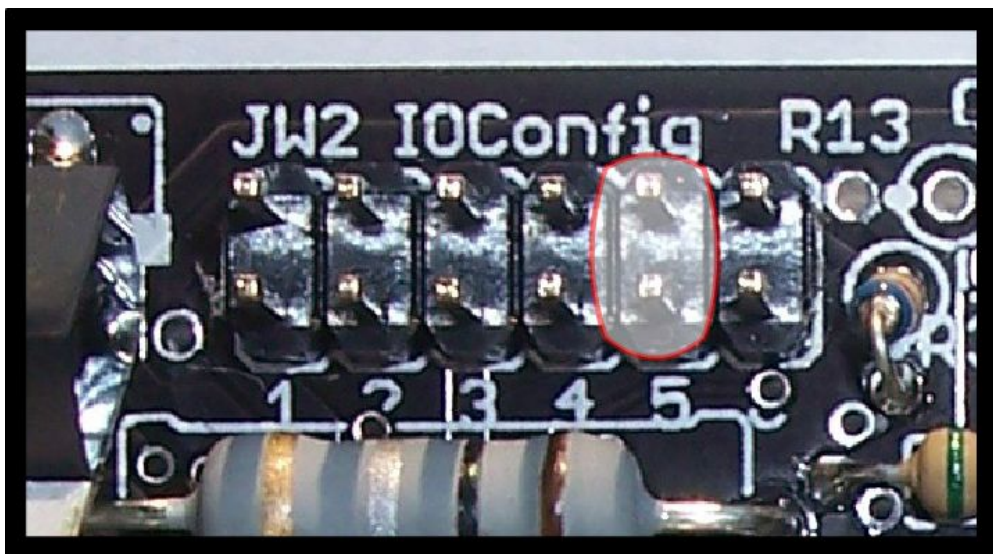

### Ford Cruise Buttons:

For this configuration, you will need to solder the Dark Blue wire (Pin 14 on the Vehicle Connector) to the Blue / Black striped wire that connects the steering wheel buttons to the cruise module. (Follow the guidelines for soldering found in the “General Installation” section.) The Light Blue wire is not needed for this configuration. The Manutronic jumper should not be installed in the Quick 1 TCS. Be sure to use the correct settings in the Shiftware setup. To enable the Manutronic, double-click the CRUISE OFF button, and press ON or OFF once to disable it.

### Manutronic Connections Ford Cruise Buttons

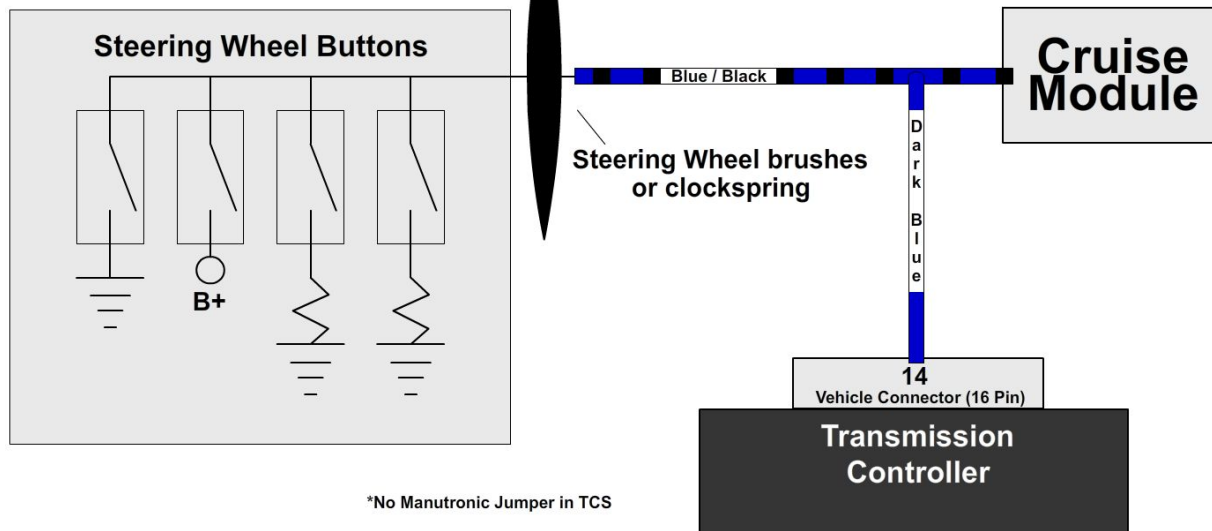

### Ford Cruise Buttons without Cruise Module:

For this configuration, you will need to connect the Dark Blue wire (Pin 14 on the Vehicle Connector) to the steering wheel buttons. The Light Blue wire is not needed for this configuration. Remember that the Manutronic jumper must be installed in the Quick 1 TCS and the correct settings used in the Shiftware setup. To enable the Manutronic, press the CRUISE OFF button and do the same to disable it.

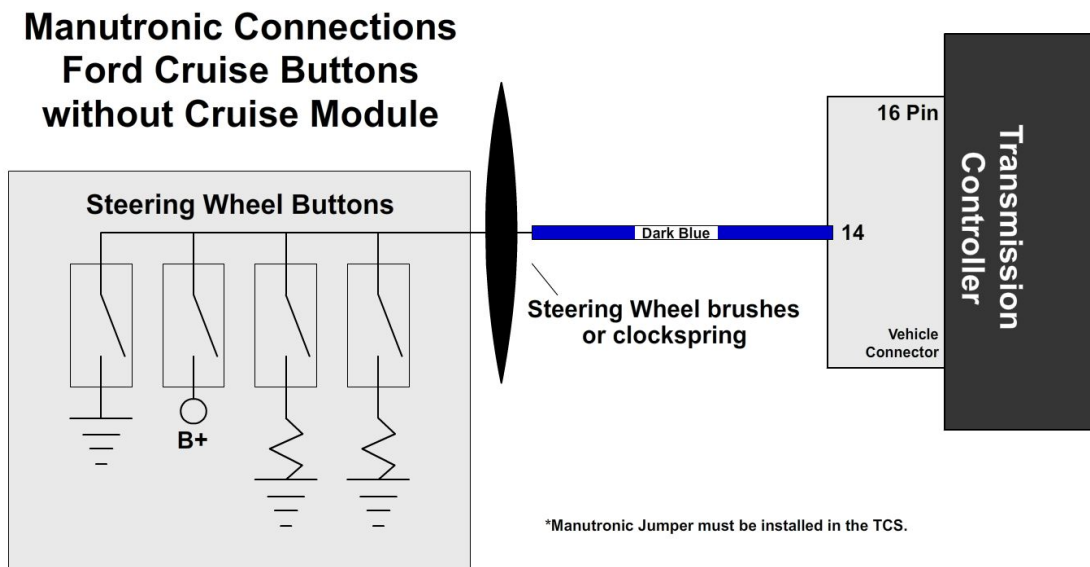

### Push-buttons with On / Off Toggle Switch:

For this configuration, you will need to connect the Dark Blue wire (Pin 14 on the Vehicle Connector) to your down-shift push-button, and connect the Light Blue wire (Pin 6 on the Vehicle Connector) to your up-shift push-button. To connect the on / off toggle switch, solder the switch's wire onto the Dark Blue down-shift wire with a 680 Ohm resistor between them. (Follow the guidelines for soldering found in the “General Installation” section.) Remember that the Manutronic jumper must be installed in the Quick 1 TCS and the correct settings used in the Shiftware setup. Manutronic will be enabled when the toggle switch is turned on and disabled when it is turned off.

### Manutronic Connections Pushbuttons with On / Off Toggle Switch

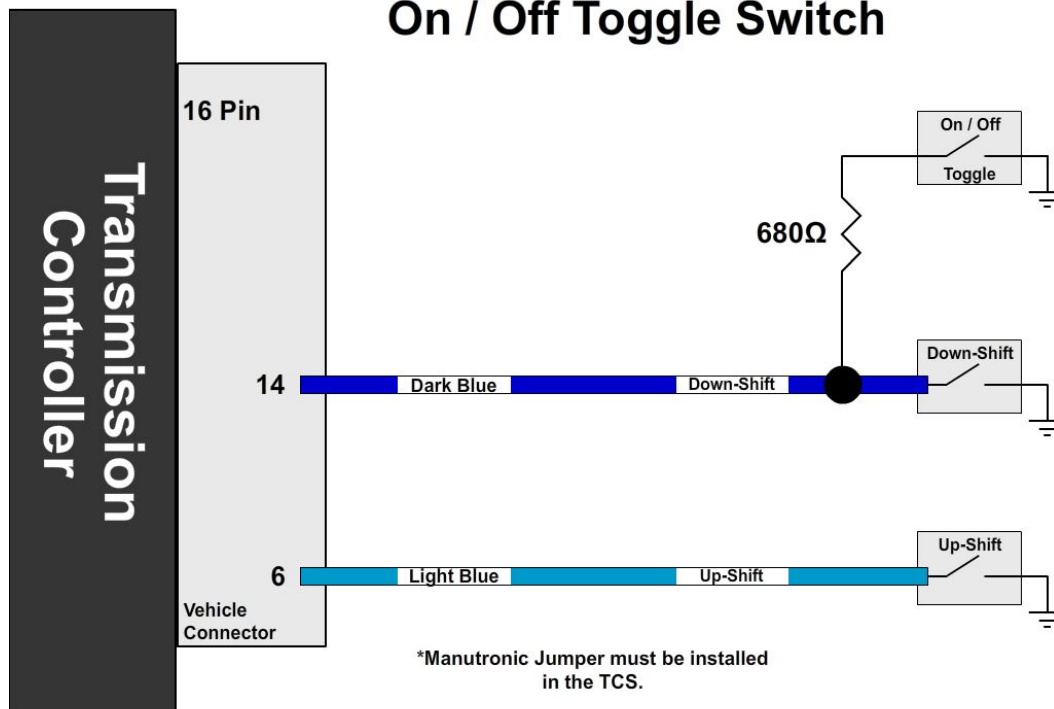

### Push-buttons with Push-button On / Off Switch:

For this configuration, you will need to connect the Dark Blue wire (Pin 14 on the Vehicle Connector) to your down-shift push-button, and connect the Light Blue wire (Pin 6 on the Vehicle Connector) to your up-shift push-button. To connect the on / off push-button, solder one side of the switch onto the Dark Blue down-shift wire and the other side to the Light Blue up-shift wire. (Follow the guidelines for soldering found in the “General Installation” section.) Remember that the Manutronic jumper must be installed in the Quick 1 TCS and the correct settings used in the Shiftware setup. To enable the Manutronic, press the On/Off button once, and do the same to disable it.

### Manutronic Connections Pushbuttons with Pushbutton On / Off Switch

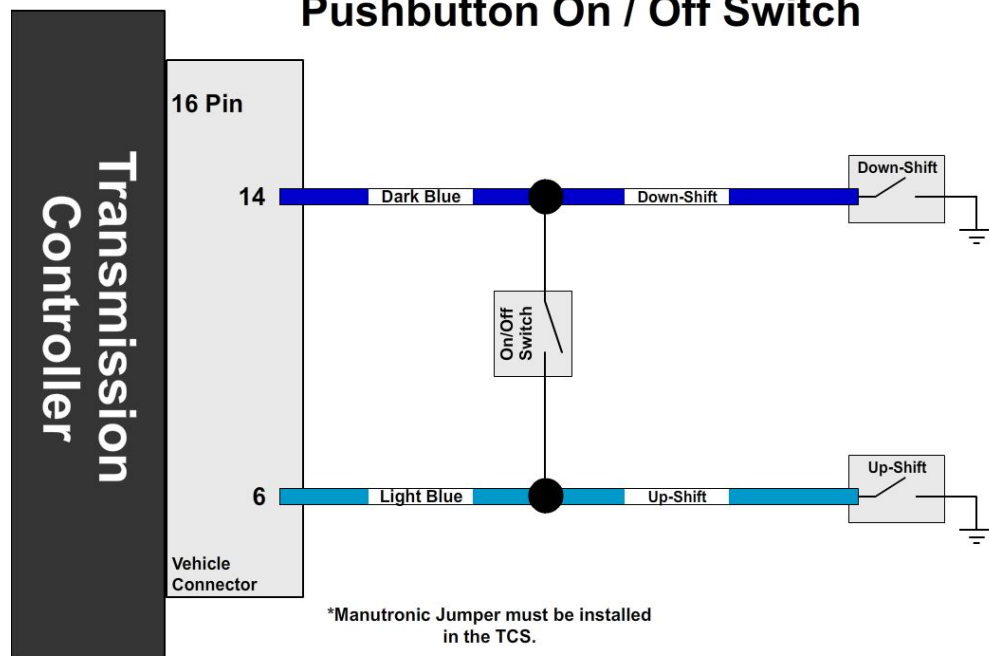

### Twist Machine Shrifter™:

For this configuration, you will need to connect the Dark Blue wire (Pin 14 on the Vehicle Connector) to COM2 of the receiver, and connect the Light Blue wire (Pin 6 on the Vehicle Connector) to COM1 of the receiver. You can use either a push-button on / off switch or a toggle on / off switch. Refer to the previous two sections on how to install and use the on / off switch. Remember that the Manutronic jumper must be installed in the Quick 1 TCS and the correct settings used in the Shiftware setup.

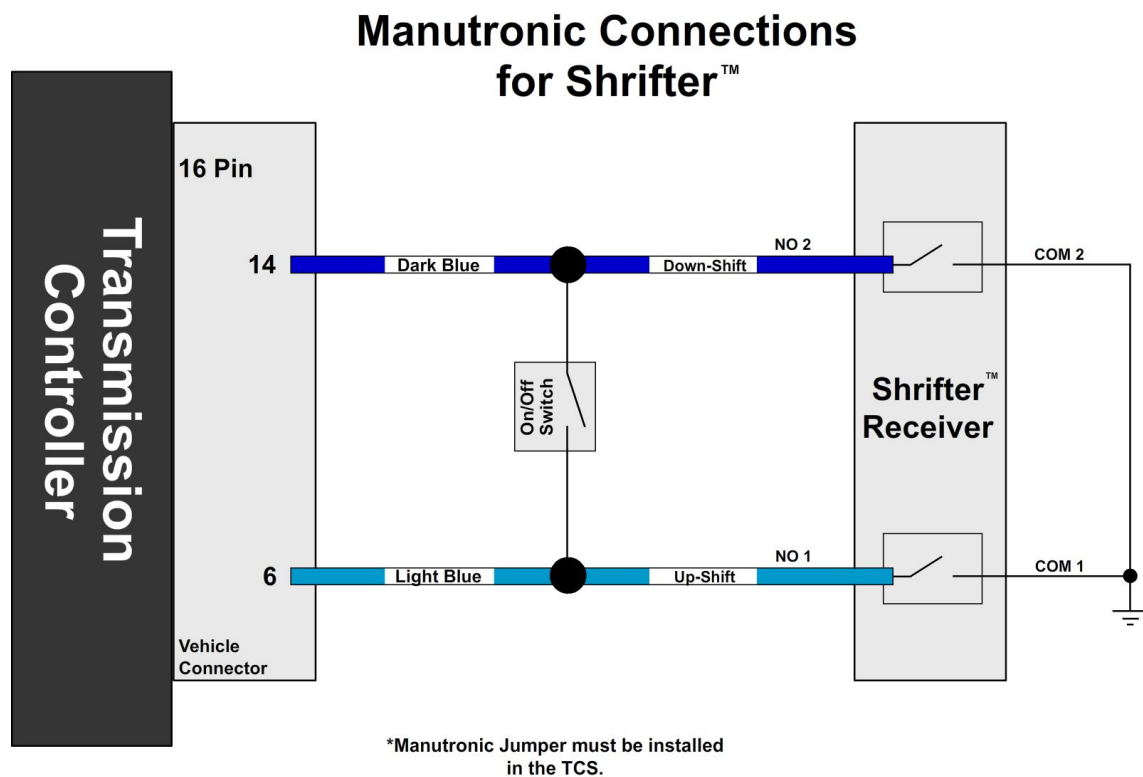

## SHIFTWARE

### Introduction:

Using the Shiftware software allows you to modify the way your Quick 1 Transmission Control System behaves. You can customize shift-points as well as monitor and diagnose the Quick 1 unit in real-time.

### Setup:

To create a calibration for the Quick 1, you can either use the wizard or load one of the supplied files included on the Shiftware disc.

To use the setup wizard, click the **New**  button. The wizard will guide you through the setup process.

To load a standard configuration for your transmission, click the **Open**  button on the toolbar, then browse to the folder where the transmission calibration files are located. The files are named according to the transmission and RPM range. (Calibrations are saved as “.BTC” files.) Choose the calibration file and click **Open**.

Once the calibration file is loaded, click the **System Settings**  button on the toolbar to check the settings and make sure that they are correct for your transmission. The System Settings window has several tabs within it. Click each one to see each section of settings specific for your transmission.

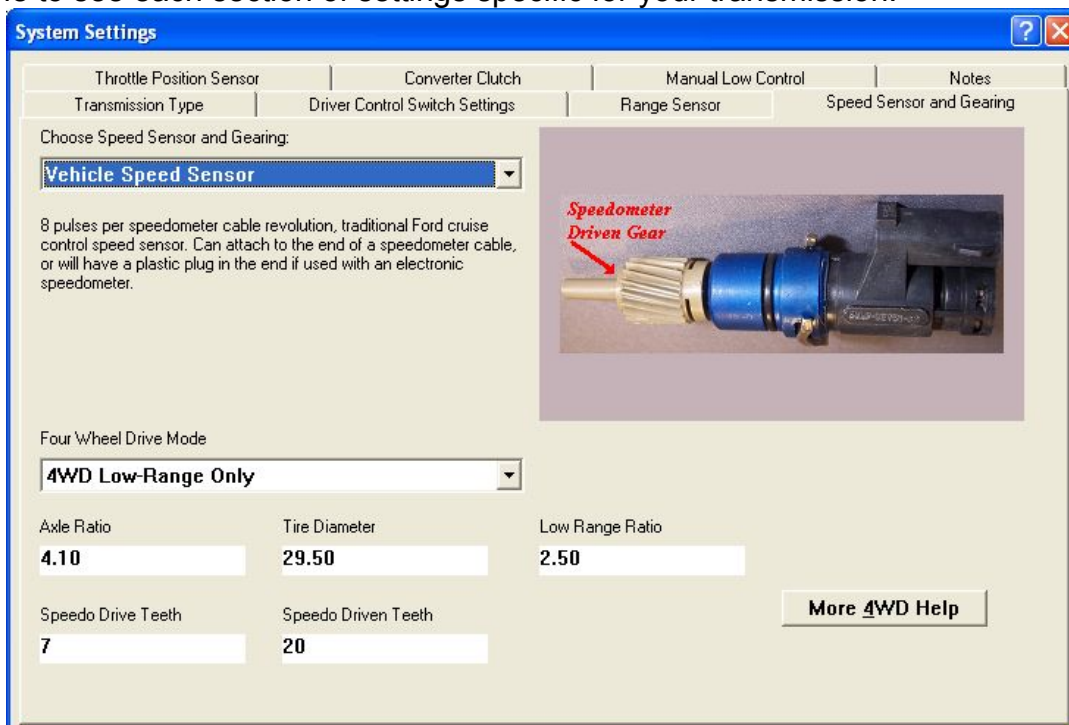

The System Settings Window

**Customize:**

The main window is where all of the shift points and line pressure editing is done. The graph displays the up-shift and down-shift speeds in relation to throttle position for each shift. It also displays the line pressure curve (otherwise known as the EPC current) in relation to throttle position. The *lower* the line pressure curve is on the graph, the *higher* line pressure will be.



The Main Window

(You can get help on any control by clicking the **Question**  button and then clicking on an item. You can also look at help topics in the HELP menu.)

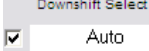

The graph has ten points from left to right, 0 being idle and 9 being Wide-Open-Throttle (WOT). On the left side of the graph is speed in miles per hour. Click on a point in the graph to select it. (If Automatic Down-shift is enabled, then the corresponding down-shift point will be automatically selected along with the up-shift point. This can be turned off by clicking the **Downshift Select**  Auto checkbox on the right.) You can select multiple points by holding CTRL while clicking the points, or a range of points by holding SHIFT and clicking the two



points on each end. You can move between adjacent points using the LEFT and RIGHT arrow keys.

Once a point (or points) is selected, you can drag it with the mouse to raise and lower its value. A yellow box will appear in the graph telling you what the value of the point is.

### Tables:





You can create more than one calibration, and use the **Table**   buttons on the toolbar to select whether the current calibration file will be read from or written to table 1 or 2. The two table spaces in the controller are separate and independent, and each can hold a separate calibration file. An optional Table Select Switch can be added to the Quick 1 system to switch between them. (See “Optional Accessories”)

### Save & Load:

Once you have created your calibration, you can save the file to your hard drive or an external storage device. To save, click the **Save**  button on the toolbar. Then browse to the location where you want it saved and click **Save**. Use “Save As” under the FILE menu to leave the original file unchanged and create a new version. Type the desired filename and click **Save**. Files are saved with a “.BTC” extension.

To load a calibration file, click the **Open**  button on the toolbar. Then, browse to the file and click **Open**.

### Writing a Calibration to the Quick 1:

For the changes you've made to take effect on the Quick 1 TCS, you first must write the calibration to the unit. Connect the Quick 1 to your computer using a standard USB cord (Type A to Type B). First, select the table you wish to write to the Quick 1 unit by clicking either the **1** or **2**   buttons on the toolbar. Then, click the **Write Calibration**  button on the toolbar. Once the Shiftware is finished writing the calibration, you can repeat these steps for the other table. When the Quick 1 unit is disconnected from the computer, the **Write Calibration**  button will be grayed out.

## **IMPORTANT INFORMATION**

### **How to Avoid Errors:**

The Shiftware software gives you complete freedom and flexibility to customize your shifting calibration however you want. This freedom requires diligence to avoid errors.

It is *very* important that the up-shift and down-shift curves for a given gear do not cross. The up-shift point at any throttle position should usually be at least 15% greater than the down-shift point. For instance, if the 2-3 up-shift point at ½-throttle is 45MPH, then the 3-2 down-shift point should usually be less than 40MPH.

The “On-Off” differential between up-shift and down-shift points is called Deadband (also known as Hysteresis). The more deadband you use for your shift points, the more stable the system will be. Not using enough deadband can result in erratic shift behavior. Too much deadband will result in sluggish behavior due to a reluctance to down-shift.

Pay close attention to the interaction between different shifts. Overlapping the 1-2 and 2-3 shifts can cause skipped gears and other drivability problems.

Also note that torque converter slip at low speeds renders engine RPM values meaningless. It is usually desirable to have light-throttle shift points within a low RPM range. In this case, it is best to base light-throttle shift points on vehicle speed, rather than engine RPM (as most auto manufacturers do).

## **TROUBLESHOOTING**

### **WARNING!**

**If the transmission does not begin to operate correctly within the first few feet of the road test, **STOP** immediately, check the troubleshooting guide, and call Baumann Electronic Controls if you need assistance. In some cases, just a few blocks of operation with low fluid pressure can destroy a transmission.**

### **Contact:**

If you have any questions, problems, or product orders, please do not hesitate to call our customer service line at (864) 646-8920 (Monday-Friday 10AM-6PM EST). If no one is available, please leave a detailed message and we will reply promptly. Whenever possible, we will try to return urgent technical support calls left after hours or over the weekend.